

# Series 5000 quick-release couplings

Nominal diameters: 5, 7 mm

Couplings threads: G1/8, G1/4, G3/8, G1/2

Plastic tubes: 6/4, 8/6, 10/8; rubber hoses: 6x14, 8x17, 10x19, 13x23



Series 5000 quick-release couplings are suitable in situations where, for plant engineering or safety reasons, the connection or disconnection of tubing must be repeated several times. These operations can be performed with no need to release the pressure and therefore a considerable amount of time can be saved.

Series 5000 quick-release couplings with mini-profile DN 5 are compatible with couplings Rectus Series 21 - 90, Legris 21.

Series 5000 quick-release couplings with European profile DN 7 are compatible with couplings Cejn Series 320.

## GENERAL DATA

Valve group	quick release valve
Construction	poppet type
Mounting	threaded
Thread	GAS cylindrical ISO 228 (BSP)
Materials	nickel-plated brass (hardened galvanized steel only for couplings with an "8" as third number in the code) - NBR seals
Connections	G1/8 - G1/4 - G3/8 - G1/2 for plastic tubes and rubber hose
Operating temperature	0°C ÷ 80°C (with dry air -20°C)
Operating pressure	- 0.99 ÷ 12 bar
Nominal pressure	6 bar
Nominal flow	see graph
Nominal diameter	5 or 7 mm
Fluid	compressed air and other low pressure fluids

## Quick-release couplings

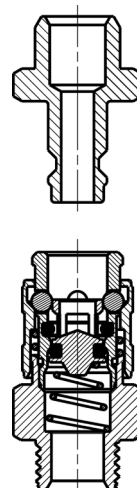

### Flow rate diagram

The side diagram supplies some useful information about the most suitable model to be used in relation to the operating pressure and the required flow rate. The measurements were taken using the models indicated below and represent the ideal maximum flow rate conditions.

In case tubes of inferior quality are used, this might result in poorer performance.

$Q$  (NL/min) = flow  
 $\Delta p$  (bar) = pressure variation

$P_a$  (bar) = inlet pressure

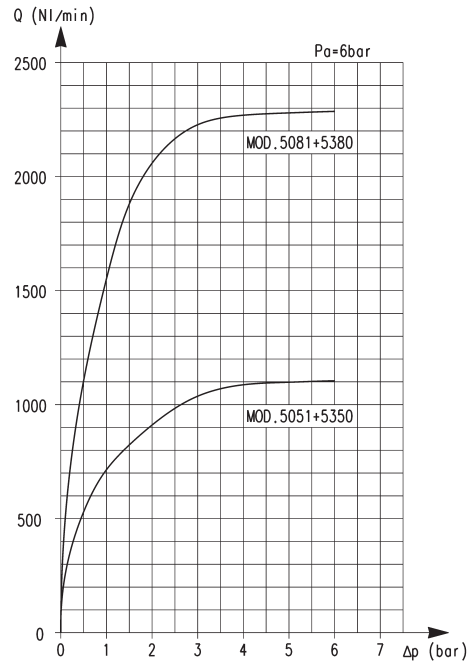

SERIES 5000 QUICK-RELEASE COUPLINGS

**Fittings Mod. 5051 Series Mini and Mod. 5081 European Standard**



BSP Male Quick Coupling

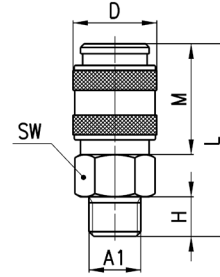

DIMENSIONS								
Mod.	A1	∅	D	H	L	M	SW	Weight (g)
5051 1/8	G1/8	5	17	6	35	20,5	14	28
5051 1/4	G1/4	5	17	8	37	20,5	17	37
5081 1/4	G1/4	7	25	8	47,5	34,5	22	93
5081 3/8	G3/8	7	25	9	48,5	34,5	22	92
5081 1/2	G1/2	7	25	10	49,5	34,5	24	107



**Fittings Mod. 5052 Series Mini and Mod. 5082 European Standard**



BSP Male Quick Coupling Bulkhead

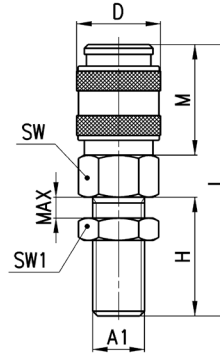

DIMENSIONS										
Mod.	A1	∅	D	H	L	M	max	SW	SW1	Weight (g)
5052 1/8	G1/8	5	17	23	52	20,5	12	14	14	38
5052 1/4	G1/4	5	17	24	53	20,5	12	17	17	52
5082 1/4	G1/4	7	25	24	63,5	34,5	12	22	17	103

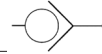

**Fittings Mod. 5053 Series Mini and Mod. 5083 European Standard**



BSP Female Quick Coupling

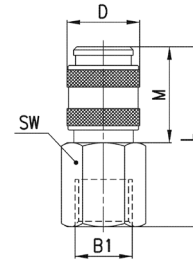

DIMENSIONS								
Mod.	B1	∅	D	L	M	SW	Weight (g)	
5053 1/8	G1/8	5	17	37,5	20,5	14	33	
5053 1/4	G1/4	5	17	39,5	20,5	17	44	
5083 1/4	G1/4	7	25	47,5	34,5	17	88	
5083 3/8	G3/8	7	25	49	34,5	20	93	
5083 1/2	G1/2	7	25	53	34,5	24	103	

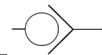

**Fittings Mod. 5054 Series Mini and Mod. 5084 European Standard**



Quick Coupling Push-on

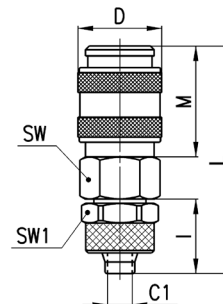

DIMENSIONS										
Mod.	Tube	∅	C1	D	I	L	M	SW	SW1	Weight (g)
5054 6/4	6/4	5	3	17	15	44	20,5	14	12	36
5054 8/6	8/6	5	5	17	15	44	20,5	14	14	38
5084 8/6	8/6	7	5	25	15	54,5	34,5	22	14	99
5084 10/8	10/8	7	6,5	25	16,5	56	34,5	22	16	103

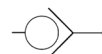

**Fittings Mod. 5055 Series Mini**



Quick Coupling Bulkhead Push-on

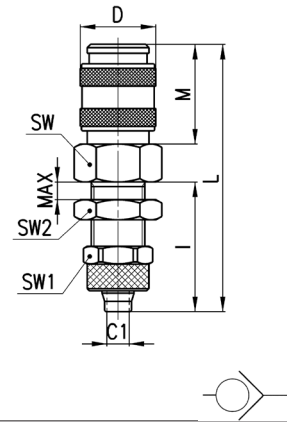

DIMENSIONS												
Mod.	Tube	∅	C1	D	I	L	M	Max	SW	SW1	SW2	Weight (g)
5055 6/4	6/4	5	3	17	29	58	20.5	10	14	12	14	44
5055 8/6	8/6	5	5	17	29	58	20.5	11	17	14	17	52

**Fittings Mod. 5056 Series Mini and Mod. 5086 European Standard**



Quick Coupling Hose Adapter

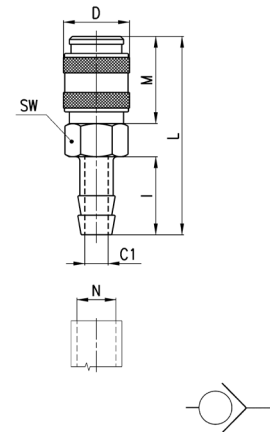

DIMENSIONS										
Mod.	N	∅	C1	D	I	L	M	SW	Weight (g)	
5056 06	6	5	3	17	20	49	20.5	14	30	
5056 09	9	5	5	17	20	49	20.5	14	32	
5086 09	9	7	5	25	20	59,5	34,5	22	95	
5086 12	12	7	8	25	20	59,5	34,5	22	96	

**Fittings Mod. 5057 Series Mini and Mod. 5087 European Standard**



Quick Coupling Hose Connector

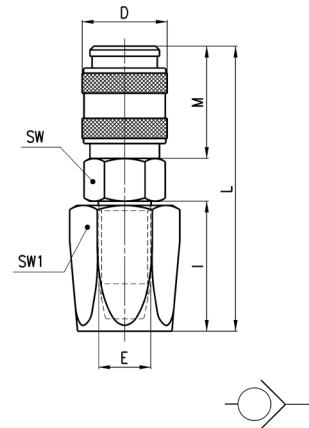

DIMENSIONS										
Mod.	Tube	∅	E	D	I	L	M	SW	SW1	Weight (g)
5057 6x14	6 x 14	5	9	17	25	54,5	20.5	17	17	62
5087 6x14	6 x 14	7	9	25	25	64,5	34,5	22	17	117
5087 8x17	8 x 17	7	10	25	25	64,5	34,5	22	19	123
5087 10x19	10 x 19	7	12	25	27	66,5	34,5	22	22	141
5087 13x23	13 x 23	7	15	25	37	76,5	34,5	22	27	195

**Fittings Mod. 5058 Series Mini and Mod. 5088 European Standard**



Quick Coupling with Spring

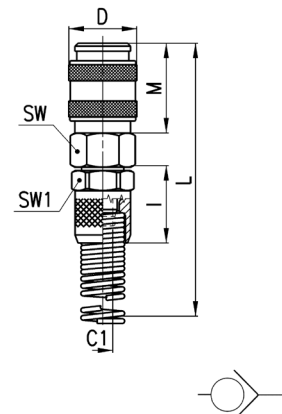

DIMENSIONS										
Mod.	Tube	∅	C1	D	I	M	L	SW	SW1	Weight (g)
5058 6/4	6/4	5	3	17	19	20.5	120.5	14	14	48
5058 8/6	8/6	5	5	17	19	20.5	124.5	14	14	54
5088 8/6	8/6	7	5	25	19	34,5	135	22	14	118
5088 10/8	10/8	7	6,5	25	21,5	34,5	139,5	22	16	125

**Fittings Mod. 5150 Mini Profile and Mod. 5180 European Profile**



Male Connector

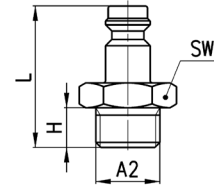

DIMENSIONS						
Mod.	A2	∅	H	L	SW	Weight (g)
5150 1/8	G1/8	5	6	26	13	12
5150 1/4	G1/4	5	8	28.5	17	19
5180 1/4	G1/4	7	8	33	17	21
5180 3/8	G3/8	7	9	34	19	26
5180 1/2	G1/2	7	10	35,5	24	34

**Fittings Mod. 5350 Mini Profile and Mod. 5380 European Profile**



Female Connector

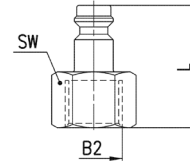

DIMENSIONS						
Mod.	B2	∅	L	SW	Weight (g)	
5350 1/8	G1/8	5	25,5	13	14	
5350 1/4	G1/4	5	27,5	17	18	
5380 1/4	G1/4	7	31,5	17	21	
5380 3/8	G3/8	7	32,5	19	23	
5380 1/2	G1/2	7	36,5	24	37	

**Fittings Mod. 5450 Mini Profile and Mod. 5480 European Profile**



Push-on Connector

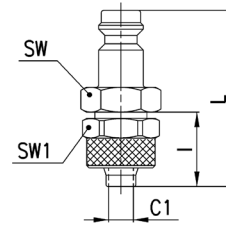

DIMENSIONS								
Mod.	Tube	∅	C1	I	L	SW	SW1	Weight (g)
5450 6/4	6/4	5	3	15	35	12	12	17
5450 8/6	8/6	5	5	15	35	13	14	22
5480 8/6	8/6	7	5	15	39,5	14	14	25
5480 10/8	10/8	7	6,5	16,5	41,5	17	16	33

**Fittings Mod. 5650 aMini Profile and Mod. 5680 European Profile**



Connector with Barb

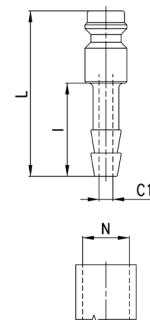

DIMENSIONS						
Mod.	N	∅	C1	I	L	Weight (g)
5650 06	6	5	3	20	35.5	8
5650 09	9	5	5	20	35.5	11
5680 06	6	7	3	20	40	14
5680 09	9	7	5	20	40	15
5680 12	12	7	7	20	40	19

**Fittings Mod. 5750 Mini Profile and Mod. 5780 European Profile**



Hose Connector

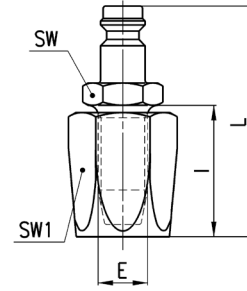

DIMENSIONS								
Mod.	Tube	∅	E	I	L	SW	SW1	Weight (g)
5750 6x14	6 X 14	5	9	25	45	14	17	40
5780 6x14	6 X 14	7	9	25	50	14	17	44
5780 8x17	8 X 17	7	10	25	50	14	19	50
5780 13x23	13 X 23	7	15	37	62	19	27	123

**Fittings Mod. 5850 Mini Profile and Mod. 5880 European Profile**



Connector with Spring

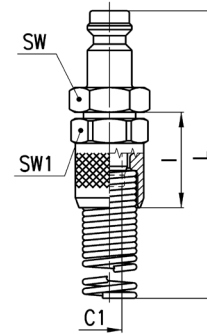

DIMENSIONS								
Mod.	Tube	∅	C1	I	L	SW	SW1	Weight (g)
5850 6/4	6/4	5	3	19	111,5	12	12	27
5850 8/6	8/6	5	5	19	116	14	14	40
5880 8/6	8/6	7	5	19	120	14	14	44
5880 10/8	10/8	7	6,5	21,5	125	17	16	55