



**Transair®**

**Advanced Pipe Systems for Industrial Fluids**

Compressed Air - Vacuum - Inert Gas - Industrial Water and Oil



ENGINEERING YOUR SUCCESS.

TRANSAIR®, FROM THE TECHNICAL ROOM

TO THE HEART OF PRODUCTION

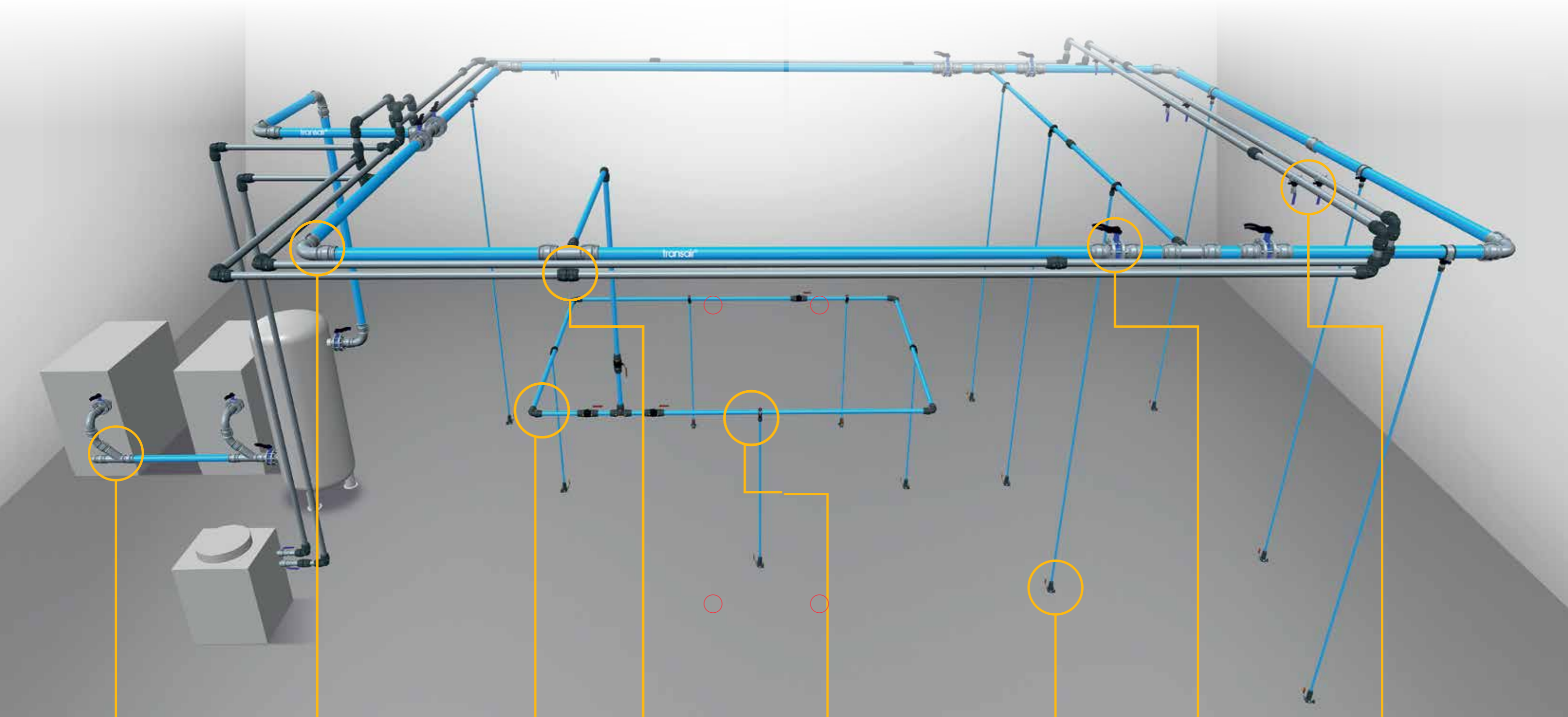

Technical Room

Main Ring

Secondary Ring

Industrial Water

Drop

Point of Use

Isolation Valve

Take Off



# Transair®

## Advanced Pipe Systems for Industrial Fluids



### ALUMINIUM RANGE

- **Calibrated Aluminium Pipe**  
Qualicoat Painting
- **Diameters (in mm)**  
16.5 - 25 - 40 - 50 - 63 - 76 - 100 - 168
- **Colours**  
Available in blue - grey - green  
Other colours upon request
- **Maximum Working Pressure**
  - 16 bar (-20°C to 45°C) up to 100 mm
  - 13 bar (-20°C to 60°C) for all diameters
  - 7 bar (-20°C to 85°C) for all diameters
- **Vacuum Level**  
99% (10 mbar absolute pressure)
- **Working Temperature**  
-20°C to 85°C
- **NBR Seals**
- **Compatibility**  
Lubricated or oil-free compressed air, industrial vacuum, nitrogen (99.99% purity), inert gas.

### STAINLESS STEEL RANGE

- **Stainless Steel Pipe**  
AISI 304 or 316L
- **Diameters (in mm)**  
22 - 28 - 42 - 60 - 76 - 100
- **Maximum Working Pressure**
  - 10 bar (-20°C to 60°C) for all diameters
  - 7 bar (-20°C to 90°C) for all diameters
- **Working Temperature**  
-20°C to 90°C
- **EPDM or FKM Seals**
- **Compatibility**  
Cooling water, industrial water with additives, lubricating oil, compressed air, vacuum, inert gas.

# Transair®

## THE Solution for your Multi-Fluid Networks



### TRANSAIR® ALUMINIUM RANGE

for Compressed Air, Vacuum and Inert Gas p.13

Technical Information	p. 14 to 23
Product Range	p. 25 to 65
Installation Guide	p. 67 to 111

### TRANSAIR® STAINLESS STEEL RANGE

for Industrial Water and Oil  
Compressed Air, Vacuum and Inert Gas p.113

Technical Information	p. 114 to 119
Product Range	p. 121 to 133
Installation Guide	p. 135 to 151
Stainless Steel Drops	p. 152 & 153

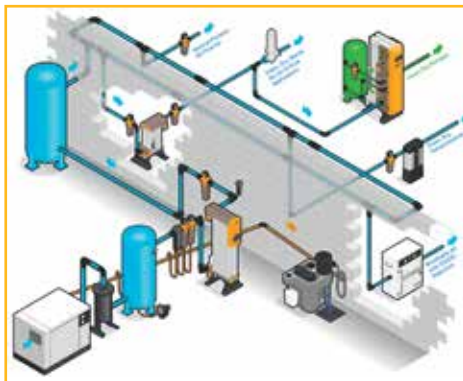

Parker Products  
from the Technical Room  
to the Heart of Production

Index

p. 154 to 157

p. 158 to 160

# Transair®

## A Business Unit of Parker Hannifin Corporation

Parker Hannifin is the world leader in motion and control technologies, working as a partner with its customers to increase their productivity and profitability. Within Parker, Transair® is the business unit specialising in projects for industrial fluids networks.





## TRANSAIR® HISTORY

**1996**

Creation of the Transair® pipework system 16.5, 25 and 40mm

**2005**

New technology for the diameters 76 & 100mm

**2010**

New diameter 168mm

**2015**

New diameter 50mm with SnapRing technology

**2000**

New technology for the diameter 63mm

**2006**

Range for cooling systems

**2012**

Multifluids range

**2016**

Stainless steel drops Ø22mm

# Transair®

## The Original Modular Pipework System for Industrial Buildings

Transair®, the original modular pipework system utilising aluminium pipe and quick connectors, was launched in 1996. Since then, with more than 20 years experience, continual improvements have been made to meet the needs of compressed air, inert gas, vacuum networks and other industrial fluids. Specialising in air network projects, Transair® fits perfectly into the Parker Group's development policy and demonstrates its capacity for innovation. Transair® is perfectly adapted to the constraints and needs of all industries and is recognised for its performance, from the compressor room to the point of use, in most industrial sectors.





# Transair®

## The Best System for Industrial Fluids

### A Technology with Multiple Assets

Transair® is the ideal solution for all compressed air, inert gas, vacuum and industrial fluid networks, by combining adaptability, quick installation, high performance and durability, while improving the profitability and reducing the related maintenance and operating costs of your networks.

### Quick

- No need to weld, glue or crimp.
- Lightweight for easy handling.
- Ready-to-use.

### Cost Effective

- Optimised installation, labour and operation costs.
- Sustainability of equipment and filtration devices.

### Longevity

- Corrosion-free construction.
- Quality of the internal surface for a sustained cleanliness of the fluid.
- 10 year guarantee

### High Performance

- Low roughness coefficient of stainless steel and aluminium pipe and full bore design.
- Optimisation of flow and pressure losses with innovative technology.

### Adaptable

- Various drop solutions thanks to brackets: with swan neck or direct, with push-in technology or threaded.
- Technologies offering the best compromise between safety, efficiency and adaptability.

## Transair® is Suitable for Most Business Sectors

Recognised for its performance, Transair® is installed, from the technical room to the points of use, in most industrial sectors, such as:

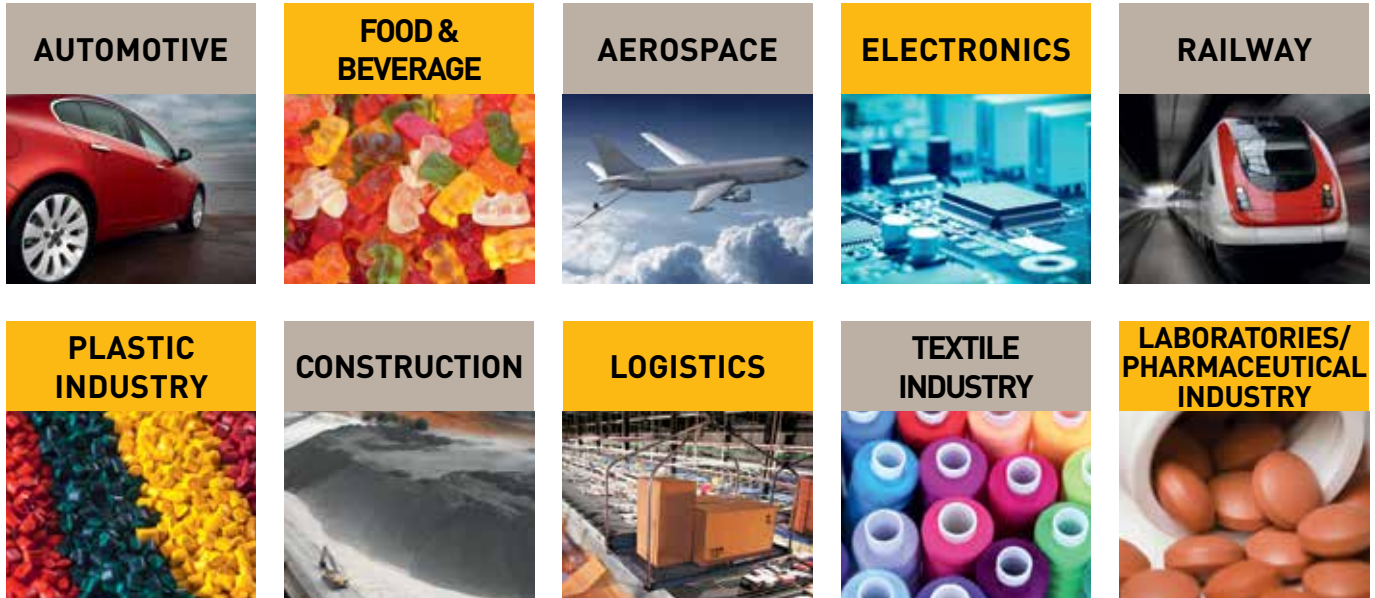

## For All Types of Projects

### Transair® is the best choice for a new installation or extension

As a specialist in industrial fluid networks, Transair® offers an innovative solution that meets the users demands, whether for the energy source, the main ring or to feed the points of use:

- High flow performance for all diameters resulting in **higher efficiency**.
- **Air quality** (ISO 8573-1 class 1.1.1) from the production to the point of use.
- **Secured connection** regardless of the environment (compressor room, outdoor...).
- Lightweight and compact products to improve **working conditions** and provide **easy installation**.
- Quick and easy installation for easier maintenance and **reduced downtime**.
- Dismountable system and reusable products for **low depreciation** on capital.



### Transair® is the best choice to retrofit old networks

Transair® is the economical, reliable and efficient alternative to traditional steel networks. Change old steel pipe network for Transair® to optimise your operation costs and to benefit from high impacts on your productivity:

- Lower roughness and larger inner diameter: **maximum flow 20% higher** than with steel pipe, **energy savings** in compressor.
- Corrosion free: **reducing the costs** of changing filter elements.
- Constant air quality for **reduction of maintenance costs** for machines and equipment.





# Transair®

## The Largest Offer of Tools and Services

The Transair® offer combines a wide range of tools and services to support every step of a project for industrial fluid networks: design, estimation, delivery, installation.

### DESIGN



#### Sizing tools to select the right diameter:

- **Transair® Flow Calculator** for compressed air and inert gas networks.
- **Transair® Vacuum Calculator** for vacuum networks.

#### Transair® CAD Drawings

Transair® core products available in more than 60 CAD formats, 2D or 3D, neutral or native.

### Special Products

For specific needs, we can develop tailor-made products. All these products are tested according to the same quality procedures as the standard products.



### ESTIMATION



#### Calculation Tools for a Budget

**3 tools available online** to calculate the budget of a Transair® network according to the project status:

- **Pre-quote tool** to estimate the necessary budget in a few seconds.
- **Quote tool** to determine the most accurate bill of material and associated budget.
- **Transair® Energy Efficiency Calculator** evaluates the return on investment of a Transair® solution compared to a traditional steel network, for compressed air network projects - new or replacement.



#### Transair® Quotation Service

A dedicated team to support complex Transair® projects, including technical studies, estimations of installation times, detailed bill of material and related weight/volume.

Available by e-mail at [transair.quotation@parker.com](mailto:transair.quotation@parker.com)

## DELIVERY

### GeoLoc: The Geolocation Service proposed by Transair®

- **Transair® real-time delivery tracking service** from the shipping site to the work site.
- **Built-in GSM beacon** for on-site direct deliveries.
- **Localisation of deliveries** throughout the shipment, with sending of programmable alerts.
- **Optimised organisation** of work sites.



### Logistics Expertise

Logistical conditions adapted to the customers' expectations:

- **Tailor-made packaging** to facilitate material handling and storage.
- **Delivery** at required date for optimisation of handling resources.
- **Shipment scheduling** to streamline the organisation of building sites.



## INSTALLATION

An installation kit is available for each project take off, including:

- **A pocket guide** to answer most questions about installation rules, together with the associated poster
- **A poster** of the main dimensions of the Transair® products to calculate the length of pipes required
- **Recommendations for the commissioning** of a compressed air network
- **A poster featuring the core products** to facilitate restocking

**If necessary, our teams and partners are available to accompany you at any time on a construction site.**



# Transair® The Quality Benchmark

## PRODUCTS

### Product Quality

All Transair® products are tested and controlled at every stage of the production process to ensure maximum efficiency for the user. Our products have to succeed a series of drastic tests: static and dynamic leak tests, burst pressure, cycled pressure and accelerated ageing tests.



## STANDARD AND REGULATION UNIVERSE

### Quality System

#### I ISO Certification

Parker Hannifin is certified ISO 9001 version 2008 and ISO TS 16949 version 2009. ISO TS, based on Automotive Industry standards, is one of the most demanding.



### Requirements Related to Pressure Equipment

#### I ASME B31.1 / B31.3 and TSSA

The Transair® products meet the requirements of ASME B31.1 and of ASME B31.3.

The Transair® products are approved by the Technical Standards & Safety Authority (TSSA) and registered under the Canadian Registration Number (CRN).



#### I CE

The Transair® products conform the European Pressure Equipment Directive 2014/68/EU. The aims of Directive 2014/68/EU are to maintain a sufficient level of safety in the tanks, generators and piping.



#### I TÜV Certification

TÜV Rheinland certifies that Transair® products fulfill regulatory requirements for pipes under pressure according to the German AD-2000 Merkblatt technical rules and to the European Pressure Equipment Directive 2014/68/EU (DESP).



RoHS



### Environment

#### I ISO 14001

Parker Hannifin is certified ISO 14001 for its Environmental Management System, which requires to reduce the impact on the environment when manufacturing a product and launching it on the market.

#### I REACH - RoHS

All Transair® products are in compliance with the REACH and RoHS directives which limit the use of hazardous substances.

#### I Eco Design

When launching a new product, an Eco-design best practice and a life-cycle analysis are carried out to reduce the long term impact on the environment.

## Product Traceability

Transair® tracks each production batch at any stage of its manufacturing process. All products are marked individually for an optimum follow-up (batch number and barcode on packaging). The origin of the products and the material certificates are available upon request.



## Quality of the Fluids

### I ISO 8573 Certification

This international standard establishes the different quality classes in compressed air. Transair® has been successfully tested to reach the highest expectation of this standard. Transair® products will not contaminate the conveyed fluid with solid particles, water, moisture or oil.

### I Oil Free Certificate

Transair® products will not contaminate the conveyed fluid with grease or oil particles.

### I Silicone Free Certificate

Transair® products are guaranteed silicone-free, which is mandatory for premium air purity. No need to add complementary filters which increase pressure drop.

### I Labs Free Compliance

Transair® products can meet with the demanding cleanliness requirements defined by the user, especially for paint and clean rooms applications.



## Safety

### I Euroclasses EN 13501-1 & UL94 Certificate

All Transair® core products are non-flammable with no propagation of flame.

### I ATEX Directive: 2014/34/EU

This directive is mandatory for electrical and non-electrical equipment used in explosive, gaseous or dusty atmospheres. The use of Transair® products is possible according to the ATEX zoning defined by the user.

## Long Term Commitment

### I 10 Year Guarantee

Transair® products that are guaranteed for a period of 10 years against any defect from the date of the installation.

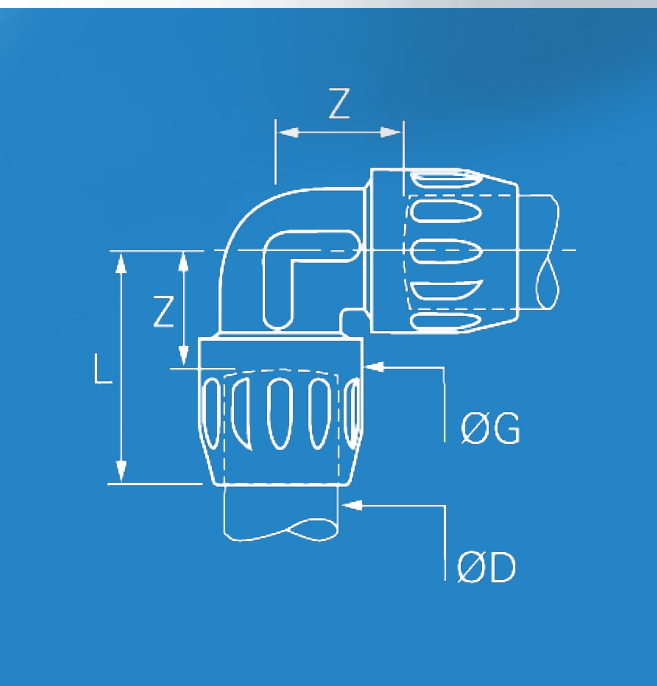



# TRANSAIR® ALUMINIUM RANGE

FOR COMPRESSED AIR,  
VACUUM AND INERT GAS



## Technical Information 14 to 23

Technical Specifications	14 to 17
Transair® Standards and Certifications	18 - 19
Transair® Applications	20 - 21
Material Aluminium Range	22
Transair® Connection Technologies	23

## Product Range 25 to 65

Rigid Aluminium Pipe	26
Fixing Clips for Rigid Pipe	28
Flexible Hoses	29
Pipe-to-Pipe & Stud Connectors	30
Ball Valves and Butterfly Valves	38
Quick Assembly Brackets	40
Wall Brackets	44
Tools	48
Fixtures and Accessories	51
FRL, Automatic Drains and Accessories	52
Hose Reels, Blowgun & Recoil Tubing	56
Hoses & Tailpiece Adaptors	57
Automatic Safety Couplers	58
Connection Accessories	62

## Installation Guide 67 to 111

The Golden Rules of Installation	68
Aluminium Pipe	70
Pipe-to-Pipe and Stud Connectors	76
Quick Assembly Brackets	88
Flexible Hoses	93
Attachment and Support	98
Practical Information	104

## Parker Products from the Technical Room to the Heart of Production 154

## Index 158

# TECHNICAL SPECIFICATIONS

## Transair® Main Features

### I Applications

Transair® is adapted for compressed air applications (dry, lubricated or with water condensation), for inert gas applications like nitrogen, argon or CO<sub>2</sub> (for purity up to 99.99%) and for vacuum applications (performance and compatibility described page 19 of this catalogue).

### I Working Pressure and Temperature

The maximum working pressure of Transair® system, versus operating temperature, is according to the diagram below.

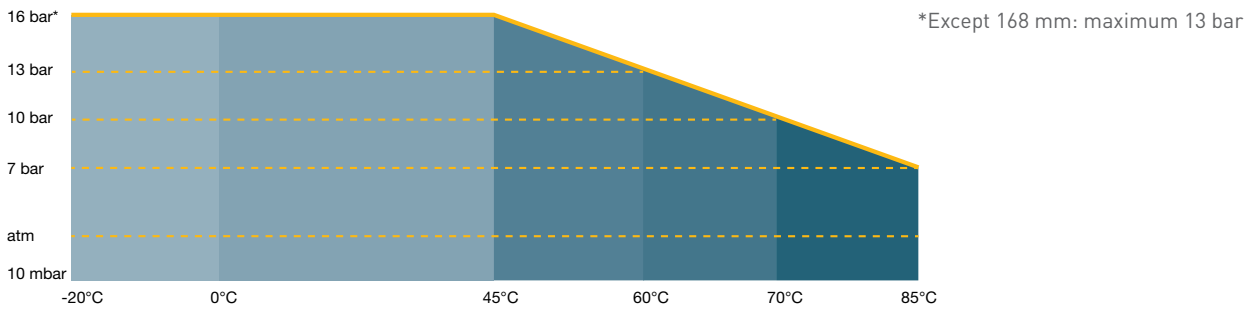

### I Maximum Flow

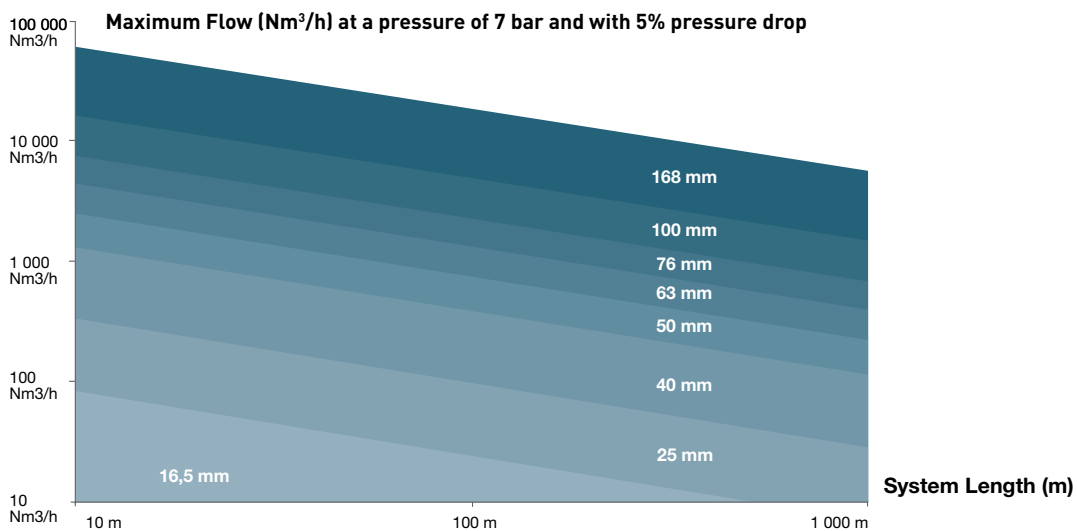

# Sizing

## Sizing a Network

Select the Transair® diameter for your application based on required flow and length. Estimated values for a closed loop network, a pressure of 8 bar with 5% pressure drop. Velocity is not taken into account.

Flow			Length										Compressor (kw)
			164ft	328ft	492ft	984ft	1640ft	2460ft	3280ft	4265ft	5249ft	6561ft	
Nm³/h	NI/min	cfm	50m	100m	150m	300m	500m	750m	1000m	1300m	1600m	2000m	
10	167	6	16.5	16.5	16.5	16.5	25	25	25	25	25	25	1
30	500	18	16.5	25	25	25	25	40	40	40	40	40	3
50	833	29	25	25	25	40	40	40	40	40	40	40	5.5
70	1167	41	25	25	25	40	40	40	40	40	40	40	7.5
100	1667	59	25	40	40	40	40	40	40	50	50	50	11
150	2500	88	40	40	40	40	40	50	50	50	50	63	15
250	4167	147	40	40	40	50	50	63	63	63	63	76	25
350	5833	206	40	40	50	50	63	63	63	76	76	76	30
500	8333	294	40	50	50	63	63	76	76	76	100	100	45
750	12500	441	50	63	63	76	76	100	100	100	100	100	75
1000	16667	589	50	63	76	76	100	100	100	100	100	168	90
1250	20833	736	63	76	76	100	100	100	100	168	168	168	110
1500	25000	883	63	76	76	100	100	100	168	168	168	168	132
1750	29167	1030	76	76	100	100	100	168	168	168	168	168	160
2000	33333	1177	76	76	100	100	168	168	168	168	168	168	200
2500	41667	1471	76	100	100	100	168	168	168	168	168	168	250
3000	50000	1766	100	100	100	168	168	168	168	168	168	168	315
3500	58333	2060	100	100	100	168	168	168	168	168	168	168	355
4000	66667	2354	100	100	168	168	168	168	168	168	168	168	400
4500	75000	2649	100	100	168	168	168	168	168	168	168	168	450
5000	83333	2943	100	168	168	168	168	168	168	168	168	168	500
5500	91667	3237	100	168	168	168	168	168	168	168	168	168	550
6000	100000	3531	100	168	168	168	168	168	168	168	168	168	600
6500	108333	3826	168	168	168	168	168	168	168	168	168	168	650
7000	116667	4120	168	168	168	168	168	168	168	168	168	168	700



# TRANSAIR® SIZING TOOLS

## Transair® Flow Calculator (TFC) and Transair® Vacuum Calculator (TVC)

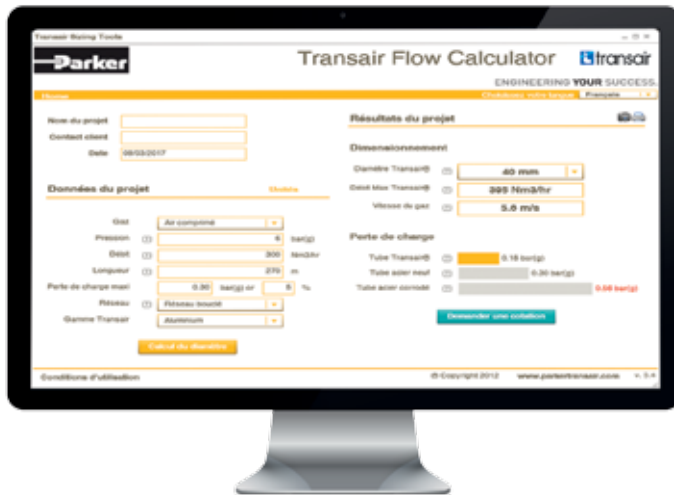

TFC and TVC sizing tools are simple, quick and easy to use.

When entering:

- the flow of the compressor or pump
- the length of the main ring (closed loop yes/no)
- the working pressure

Your network is immediately sized with the most suitable Transair® diameter for your project.

The calculation includes an estimation of pressure losses and, in the case of a compressed air or inert gas network, a recommendation of maximum flow.



These tools are available at [www.parkertransair.com](http://www.parkertransair.com):

[www.parkertransair.com/TFC](http://www.parkertransair.com/TFC)

[www.parkertransair.com/TVC](http://www.parkertransair.com/TVC)

or upon request to [transair@parker.com](mailto:transair@parker.com)

### Very easy to use:

These tools allow to obtain in just 3 steps the most appropriate Transair® pipe diameter for your network.

Both TFC and TVC include all diameters of Transair® aluminium range: 16.5 - 25 - 40 - 50 - 63 - 76 - 100 and 168mm.

- Possibility to size the diameters for compressed air, inert gases, nitrogen, dry CO<sub>2</sub> and vacuum networks.
- Intuitive tool with help tips at each step
- For compressed air and inert gases, comparison of results with a traditional steel network
- Possibility to print the outcome report

# TRANSAIR® PAYBACK TOOL

## Transair® Energy Efficiency Calculator (TEEC)

### Energy Efficiency with Transair®

The Transair® Energy Efficiency Calculator software determines the savings and the ROI (Return On Investment) timeframe using compressor data (pressure, power, annual service hours, type of dryer), plus data from the network (length of the main ring, type of open or closed loop, pipe material used) and the local cost of electricity, including an inflation factor.

The results demonstrate that Transair® is the most efficient solution and the best option in the long term.

Whether you are extending or renovating an existing system or installing a new one, you can contribute to your company's performance and help to protect the environment by choosing Transair®.

**TRANSAIR ENERGY EFFICIENCY CALCULATOR**

PROJECT ESTIMATION | FINANCIAL REPORT | OPTION UNITS | PRINT | English

**PROJECT INPUT DATA**

Project Name: [ ] 2016-10-13

**COMPRESSOR ROOM**

Pressure: [ 7 ] bar  
 Compressor power: [ 100 ] kW  
 Annual operating hours: [ 8000 ] hours/year  
 Type of dryer: [ by refrigeration ]

**COMPRESSED AIR NETWORK**

Flow in the main ring: [ 600 ] Nm<sup>3</sup>/hr  
 Length of the main ring: [ 500 ] m  
 Closed main ring: [  yes  no ]

**TRADITIONAL SOLUTION**

Pipe material: [ Black Steel ]  
 Internal diameter of the pipe: [ 80 ] mm  
 Age of the network: [ 10 ] years  
 % of leakage: [ 10 ] %  
 Quotation (products and labour): [ 0 ] EUR

**TRANSAIR**

Diameter of the Transair pipe: [ 76 ] mm  
 Quotation (products and labour): [ 2000 ] EUR

**ECONOMIC DATA**

Electricity cost per kWh: [ 0.08 ] EUR  
 Annual electricity inflation: [ 3 ] %  
 Electricity carbon emission factor: [ 0.08 ] kg CO<sub>2</sub> / kWh

**ESTIMATION OUTPUT DATA**

**PAYBACK TIME OF THE TRANSAIR SYSTEM: 29 MONTHS**

**TRANSAIR BENEFIT YEAR AFTER YEAR**  
 due to the difference of cost between Transair and traditional solution

Bar chart showing annual benefits from Year 1 to Year 10. Year 1 shows a negative value (cost), while subsequent years show positive values (benefits).

**TRANSAIR PROFIT FOR 5 YEAR(S): 39 552 EUR**

For information, the estimated pressure drop and leakage volume saved each year with Transair is equivalent to **49 593 kg CO<sub>2</sub>**

Black Steel	Pressure drop	transair
0,16 bar	0,07 bar	
552 EUR	Pressure drop cost per year	224 EUR
690 560 Nm <sup>3</sup>	Leakage volume per year	0 Nm <sup>3</sup>
7 221 EUR	Leakage cost per year	0 EUR
361 EUR	estimated repair cost per year	0 EUR
<b>8 434 EUR</b>	<b>Total Annual Cost</b>	<b>224 EUR</b>

© copyright 2012 Parker Hannifin - www.parkertransair.com

This tool is available at [www.parkertransair.com](http://www.parkertransair.com):

[www.parkertransair.com/TEEC](http://www.parkertransair.com/TEEC)

or upon request to [transair@parker.com](mailto:transair@parker.com)

# TRANSAIR® STANDARDS AND CERTIFICATIONS

Transair® aluminium range certifications fall within the standards and regulations universe described on pages 8 and 9 of this catalogue.

## Standards Related to Transair® Aluminium Pipe



### I Qualicoat Label



Transair® aluminium piping system complies with the QUALICOAT label, which guarantees the quality of the painting process, the chemicals used, the finished quality and the coating resistance of the aluminium pipe.

### I Material Certificate

Transair® aluminium piping system complies with EN 755.2, EN 755.8, EN 573.3 standards, which define mechanical and chemical properties of pipes. The quality and consistency of the aluminium alloy used allow to bend Transair® aluminium pipe as described on page 110 of this catalogue.

## Applications

### I Air Quality - ISO 8573 Certification: 2001 & 2010 Classes 1.1.1



Transair® aluminium range conforms to ISO 8573: 2001 & 2010 Classes 1.1.1 certification. ISO 8573 certification establishes the different quality classes of compressed air for the 3 main components present in any compressed air system: dust, water and grease. Transair® aluminium range has been successfully tested to reach the highest expectation of this standard. A Transair® distribution network guarantees a constant quality of the conveyed fluids, from the production point to the point of use.

ISO 8573-1:2010 Class	Solid Particulate			Mass Concentration mg/ m <sup>3</sup>	Water		Oil
	Maximum number of particles per m <sup>3</sup>				Vapour Pressure Dewpoint	Liquid g/m <sup>3</sup>	Total Oil (aerosol liquid and vapour)
	0.1 – 0.5 µm	0.5 – 1 µm	1 – 5 µm				mg/ m <sup>3</sup>
0	As specified by the equipment user or supplier and more stringent than Class 1						
1	OK*	OK*	OK*	-	OK**	-	OK
2	OK	OK	OK	-	OK	-	OK
3	-	OK	OK	-	OK	-	OK
4	-	-	OK	-	OK	-	OK
5	-	-	OK	-	OK	-	-
6	-	-	-	OK	OK	-	-
7	-	-	-	OK	-	OK	-
8	-	-	-	-	-	OK	-
9	-	-	-	-	-	OK	-
X	-	-	-	OK	-	OK	OK

\* : Transair® in line with standard after 1 purge

\*\* : Transair® in line with standard depending on the atmospheric conditions



### I Vacuum

Transair® aluminium range can be used for vacuum applications down to 10 mbar absolute pressure.

### I Compatibility with Non Flammable Gases

Transair® aluminium range is suitable for distribution of non flammable gases such as: Argon, Nitrogen, Carbon Dioxide and mix of these gases. Based on laboratory purity testing, Transair® (fitting and aluminium piping) is compatible with 99.99% purity Nitrogen applications.



Gas	Compatibility with Transair®
Nitrogen (N <sub>2</sub> )	Compatible
Argon	Compatible
Carbon Dioxide (CO <sub>2</sub> )	Compatible
Helium (He <sub>2</sub> )	Compatible
Mix Argon (Ar <sub>2</sub> ) + Carbon Dioxide (CO <sub>2</sub> )	All ratios
Oxygen (O <sub>2</sub> )	Up to 22%
Hydrogen (H <sub>2</sub> )	Up to 4%

Transair® aluminium range is compatible with transportation of above gas, according to all recommendations of uses of Transair® piping system, provided the conveyed fluid is dry (no condensation in the Transair® piping system).

## Safety

### I Euroclasses EN 13501-1 Certification

Transair® aluminium range is classified B s2 d0 according to EN 13501-1. EN 13501-1 certification describes the different classes of reaction to fire for the 3 main criteria as follows: energy contribution to the propagation of fire, smoke production and flaming particles.



Energy Contribution to the Propagation of a Fire			Smoke Production		Falling Drops	
B	Contribution limited to fire propagation	Resistant to prolonged attack flames and ardent isolated object while limiting the spread of flame.	s2	Average smoke production	d0	no drops, no flaming particles

### I Transair® Blowgun

Transair® blowgun EA59 00 13 complies with regulations OSHA 1910.242 (b) for hand and portable powered tools, OSHA 1910.95 (b), Directive 2003/10/EC.



The above mentioned certificates are available upon request.

# TRANSAIR® FOR INDUSTRIAL VACUUM

## Transair® system is particularly suited for vacuum applications:

- Diameters up to 168mm to meet all requirements
- Full flow connection for a better aspiration
- Big diameters for a maximum flow on the machine connections
- Optimum sealing to guarantee the proper functioning of the machines
- Different colours of pipe for easy network identification
- Sizing tool to ease the project study (TVC)

### Certificates :

- Vacuum Performance, 10 mbar in absolute pressure
- Air Quality ISO 8573: 2001 & 2010 Class 1.1.1

### OPTIMISED PRODUCTS FOR INDUSTRIAL VACUUM APPLICATIONS:



# TRANSAIR® FOR INERT GASES

## Transair® advantages for inert gases applications:

- Transair® materials allow to maintain the quality of the conveyed gases.
- Optimum sealing of Transair® connectors allow to maintain gases purity.
- 3 port threaded wall bracket to be used with column flowmeters
- Different colours of pipe for easy network identification
- Sizing tool for inert gases (TFC)

### Certificates:

- Suited for applications with: nitrogen, argon, CO<sub>2</sub> and their mix (exhaustive list upon request)
- 99,99 % purity with nitrogen (100 ppm oxygen)
- Air Quality ISO 8573: 2001 & 2010 Class 1.1.1

### OPTIMISED PRODUCTS FOR INERT GASES APPLICATIONS:



# TRANSAIR® FOR TECHNICAL ROOMS

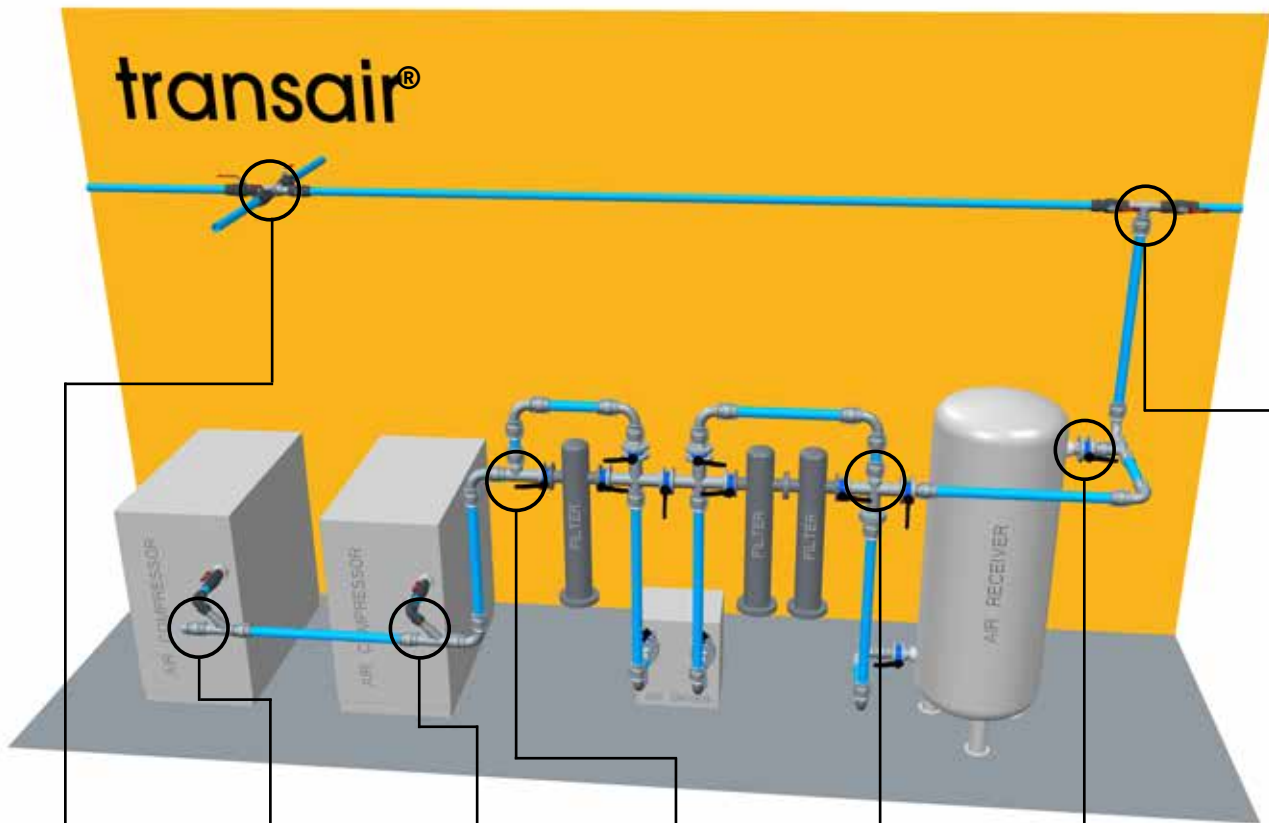

**Equal Cross  
RA07**



**End Cap  
with Plug  
RA25**



**Equal and  
Reducer Y  
RA26**



**1 Flanged Tee  
RA44**



**3 Flanged  
Cross  
RA07**

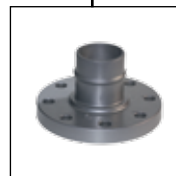

**Circular Flange  
RA30/RA31**



**Increaser Tee  
RA04**



# MATERIAL ALUMINIUM RANGE

Range References	Ø16.5 - Ø25 - Ø40	Ø50 - Ø63
1003A	Lacquered aluminium	Lacquered aluminium
1006A - 1004A	Lacquered aluminium	Lacquered aluminium
CLIP - SPACER	HR Polymer	HR Polymer
1001E	Hose and coating: black SBR Reinforcement: spiral steel wire	Hose and coating: black SBR Reinforcement: synthetic braiding
6606	HR Polymer	Treated aluminium SnapRing: HR Polymer
6676	HR Polymer	Treated aluminium
6602	HR Polymer	Treated aluminium SnapRing: HR Polymer
6612	HR Polymer	Treated aluminium SnapRing: HR Polymer
6604	HR Polymer	Treated aluminium SnapRing: HR Polymer
6666	Body: treated aluminium Nut: HR Polymer	Treated aluminium
6625	Ø16.5 mm: body: brass Nut: HR Polymer Ø25 and Ø40 mm: HR Polymer	Treated aluminium
6605	Body: treated brass Nut: HR Polymer	Treated aluminium SnapRing: HR Polymer
6615	Body: brass Plate: treated steel Nut: HR Polymer	Body: brass Plate: treated steel Nut: aluminium
6611	Brass	Brass
6609	Body: HR Polymer Male stud: brass	Body: aluminium Nut: aluminium Male stud: brass
6619	Body: HR Polymer Male stud: brass	Body: aluminium Nut: aluminium Male stud: brass
6621	Brass	
6651	Body: treated brass Nut: HR Polymer	
4092	Body: brass Nut: HR Polymer	Treated aluminium SnapRing: HR Polymer
RA69	HR Polymer	HR Polymer
RA65	Body: HR Polymer Insert: brass	Body: HR Polymer Insert: brass
6662	HR Polymer	HR Polymer
6661	Body: HR Polymer Insert: brass	Body: HR Polymer Insert: brass
VR03	Body: nickel-plated brass Seal: PTFE	
VR04	Body: nickel-plated brass Seal: PTFE	
EA98	Body: treated iron Ball valve: nickel-plated brass/ PTFE	
6639 - 6681 6682 - 6695	Body: brass Nut: HR Polymer	
6641 - 6686 6690 - 6635	Treated brass	
6678 - 6693 6637	Body: brass Nut: HR Polymer	

Range References	Ø76 - Ø100 - Ø168
TA03	Lacquered aluminium
TA06	Lacquered aluminium
Collar	Zinc steel Rubber EPDM
FP01	Hose & connector: black SBR/NBR Reinforcement: spiral steel wire
RR01	Clamp: treated steel Cartridge: HR Polymer
RR01 L8	Clamp: aluminium Cartridge: zamak + HR Polymer
RX02	Stainless Steel 304
RA02	Aluminium
RX12	Stainless Steel 304
RA12	Aluminium
RX04	Stainless Steel 304
RA04*	Aluminium
RX24	Stainless Steel 304
RX23	Stainless Steel 304
RA26**	Aluminium
RA07**	Aluminium
RA44	Aluminium
RX64	Stainless Steel 304
RX66	Stainless Steel 304
RA66	Aluminium
RA25	Aluminium
RA30*	Aluminium
RA33	Aluminium
EW05	Seal: elastomer
RR05	Treated brass
VR01	Body: iron Ball: nickel-plated brass
VR02	Handle: HR Polymer Body: iron Disk and shaft: stainless steel
RR61	Body: iron (EN 1563) - Seal:NBR Screw: treated stainless steel Lining: elastomer
RR63	Body: iron (EN 1563) - Seal:NBR Screw: treated stainless steel Lining: elastomer

\* + Ø63mm  
\*\* + Ø40, Ø50 and Ø63mm

## ALL SEALS ARE IN NBR (unless otherwise stated)

- **Adaptator:** brass
- **Fixture accessories:** galvanized steel - brass
- **Composite coupler:**
  - Body: polymer HR / Zamak
  - Sleeve: polymer HR
  - Spring and ball: stainless steel
  - Seal: nitrile
- **Metal coupler:**
  - Body: duralumin anodisé
  - Sleeve: treated nickel-plated steel

- Spring: stainless steel
- Seal: nitrile
- Probe: treated brass, treated steel

### • Hose reel :

- Case: plastic
- Fixing: metal

### • Blowgun:

Reinforced polyamid - treated aluminium - insert: brass

- **Connection accessories:** nickel-plated brass

- **Anti-whip lash strap:** steel

# TRANSAIR® CONNECTION TECHNOLOGIES

Transair® innovative technology takes into account the specific requirements of each diameter and provides the user with an optimum safety coefficient and easy connection.

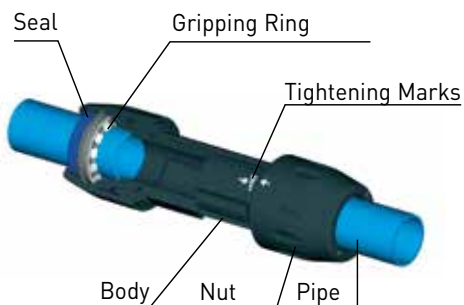

Ø16.5 - Ø25 - Ø40 mm

Simply push the pipe into the connector up to the connection mark.

The gripping ring of each fitting is then automatically secured and the connection is safe.

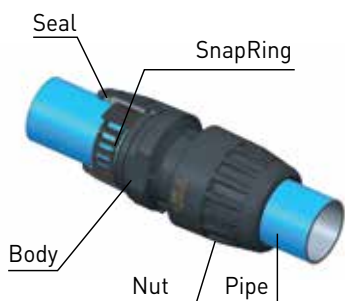

Ø50 - Ø63 mm

Transair®'s SnapRing secures the connection between the nut and the pipe - tightening of the nuts secures the final assembly

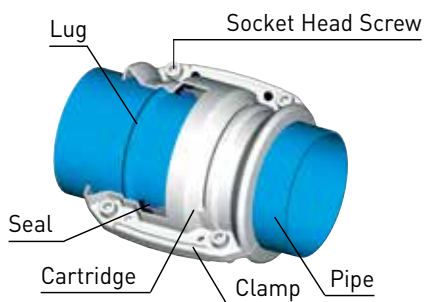

Ø76 - Ø100 - Ø168 mm

Position the pipes to be connected within the Transair® cartridge and close/tighten the Transair® clamp.

## Reliable and Safe Connection Technologies

Because users need versatile but reliable and safe solutions, Transair® has developed different technologies for the best compromise between safety, efficiency and adaptability.

- **Gripping ring instant connection** for diameters 16.5, 25 and 40mm offers the maximum flexibility.
- **SnapRing quick-fit connection** for diameters 50 and 63mm proposes the most secure technology while maintaining ease of handling: no possible errors during installation.
- **Lug & Clamp quick-fit connection** for diameters 76, 100 and 168mm avoids any disconnection: the internal cartridge works as a fuse if a failure in the network causes an excessive pressure increase.

	Mechanical Stress due to Pressure	Frequency of Modifications	Transair® Technology
Ø 16.5, 25 & 40 mm	+ (up to 250 kg)	+++++ (every quarter)	Gripping Ring Instant Connection
Ø 50 & 63 mm	++ (up to 600 kg)	+++ (every year)	SnapRing Quick-fit Connection
Ø 76, 100 & 168 mm	+++++ (up to 3000 kg)	+ (every 3 years)	Lug & Clamp Quick-fit Connection





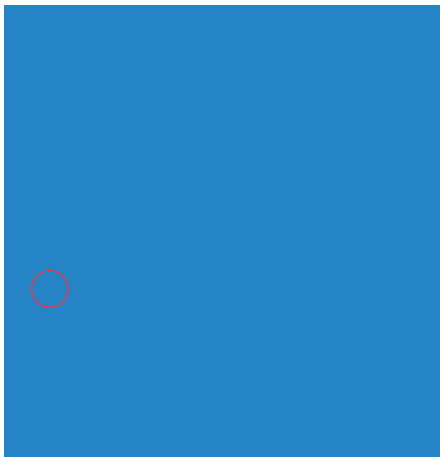

# TRANSAIR® ALUMINIUM RANGE

## PRODUCT RANGE



<b>Rigid Aluminium Pipe</b>		<b>26</b>
<b>Fixing Clips for Rigid Pipe</b>		<b>28</b>
<b>Flexible Hoses</b>		<b>29</b>
<b>Pipe-to-Pipe &amp; Stud Connectors</b>		<b>30</b>
<b>Ball Valves and Butterfly Valves</b>		<b>38</b>
<b>Quick Assembly Brackets</b>		<b>40</b>
<b>Wall Brackets</b>		<b>44</b>
<b>Tools</b>		<b>48</b>
<b>Fixtures and Accessories</b>		<b>51</b>
<b>FRL, Automatic Drain and Accessories</b>		<b>53</b>
<b>Hose Reels - Blowgun - Recoil Tubing</b>		<b>56</b>
<b>Hoses and Tailpiece Adaptors</b>		<b>57</b>
<b>Automatic Couplers</b>		<b>58</b>
<b>Connection Accessories</b>		<b>62</b>

# RIGID ALUMINIUM PIPE

- I Clean air ISO 8573: 2001 & 2010 Class 1.1.1.
- I Optimum flow rate performance
- I Lightweight
- I QUALICOAT certified surface finish
- I 3 colours: blue (RAL 5012/BS1710), grey (RAL 7001), green (RAL 6029) (others: please consult us)
- I Extruded pipe, conforms to EN 755.2, EN 755.8 and EN 573.3

∅  
16.5  
25  
40

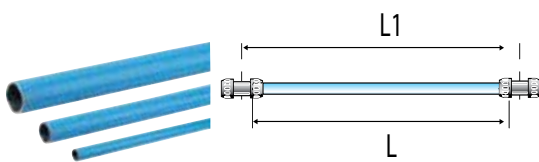

## BLUE PIPE

Transair®	∅ ext.	∅ int.	L1 (m)	L (m)	Kg
1003A17 04 00	16.5	13	3	2.930	0.660
1004A17 04	16.5	13	4.5	4.430	0.990
1003A25 04 00	25	22	3	2.903	1.040
1006A25 04 00	25	22	6	5.903	1.933
1003A40 04 00	40	37	3	2.885	1.480
1006A40 04 00	40	37	6	5.885	2.860

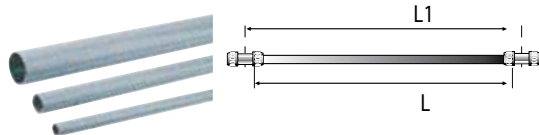

## GREY PIPE

Transair®	∅ ext.	∅ int.	L1 (m)	L (m)	Kg
1003A17 06 00	16.5	13	3	2.930	0.660
1003A25 06 00	25	22	3	2.903	1.040
1006A25 06 00	25	22	6	5.903	1.933
1003A40 06 00	40	37	3	2.885	1.480
1006A40 06 00	40	37	6	5.885	2.860

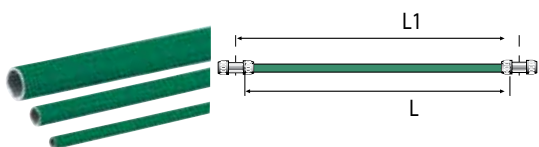

## GREEN PIPE

Transair®	∅ ext.	∅ int.	L1 (m)	L (m)	Kg
1004A17 02	16.5	13	4.5	4.430	0.990
1006A25 02 00	25	22	6	5.903	1.933
1006A40 02 00	40	37	6	5.885	2.860



### Sticker for compressed air networks

EW07 00 01

### Sticker for vacuum networks

0000 01 68

∅  
50  
63

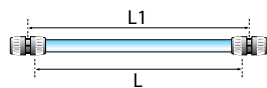

**BLUE PIPE**

Transair®	∅ ext.	∅ int.	L1 (m)	L (m)	Kg
1003A50 04	50.8	48	3	2.950	2.142
1006A50 04	50.8	48	6	5.950	4.320
1003A63 04	63	59	3	2.950	3.140
1006A63 04	63	59	6	5.950	6.175

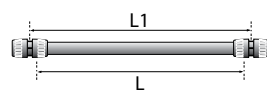

**GREY PIPE**

Transair®	∅ ext.	∅ int.	L1 (m)	L (m)	Kg
1003A50 06	50.8	48	3	2.950	2.142
1006A50 06	50.8	48	6	5.950	4.320
1003A63 06	63	59	3	2.950	3.140
1006A63 06	63	59	6	5.950	6.175

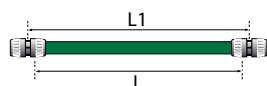

**GREEN PIPE**

Transair®	∅ ext.	∅ int.	L1 (m)	L (m)	Kg
1006A50 02	50.8	48	6	5.950	4.320
1006A63 02	63	59	6	5.950	6.175

∅  
76  
100  
168

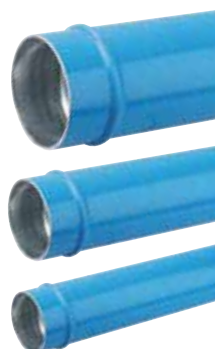

**BLUE PIPE**

Transair®	∅ ext.	∅ int.	L (m)	Kg
TA03 L1 04	76.3	72.3	3.000	3.720
TA06 L1 04	76.3	72.3	6.000	7.620
TA03 L3 04	101.8	97.2	3.000	5.840
TA06 L3 04	101.8	97.2	6.000	11.600
TA03 L8 04	168.3	161.3	3.000	14.718
TA06 L8 04	168.3	161.3	6.000	29.412

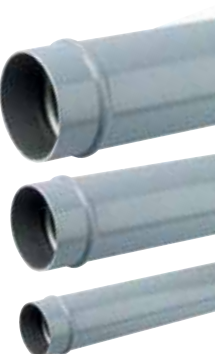

**GREY PIPE**

Transair®	∅ ext.	∅ int.	L (m)	Kg
TA06 L1 06	76.3	72.3	6.000	7.620
TA06 L3 06	101.8	97.2	6.000	11.600
TA06 L8 06	168.3	161.3	6.000	29.412

# FIXING CLIPS FOR RIGID ALUMINIUM PIPE

- I Easy adaptation for all pipework configurations
- I For suspension of pipes, from walls, partitions, beams, cable trays, Canalis electrical installations, etc, vertically or horizontally
- I Perfectly adapted for use with Transair® networks

Ø  
16.5  
25  
40

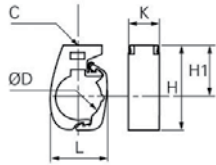

## FIXING CLIP FOR RIGID ALUMINIUM PIPE

Transair®	ØD	C	H1	H	K	L	Kg
6697 17 00	16.5	M8 x 1.25	46	61	30	33	0.027
6697 25 00	25	M8 x 1.25	46	67	30	38	0.030
6697 40 00	40	M8 x 1.25	46	74	30	50	0.035

To ensure good stability of the network, we recommend the use of at least 2 clips per pipe.  
Use only this clip for fixing Transair® rigid pipe, all other types of clip are to be avoided.

Ø  
50  
63

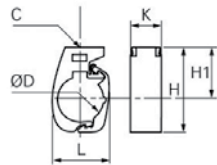

## FIXING CLIP FOR RIGID ALUMINIUM PIPE

Transair®	ØD	C	H1	H	K	L	Kg
6697 50 00	50	M10 x 1.5	90	122	30	61	0.068
6697 63 00	63	M10 x 1.5	90	127.5	30	73.5	0.073

To ensure good stability of the network, we recommend the use of at least 2 clips per pipe.  
Use only this clip for fixing Transair® rigid aluminium pipe, all other types of clip are to be avoided.

Ø  
76  
100  
168

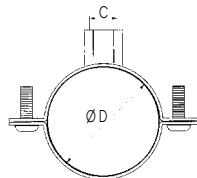

## FIXING COLLAR FOR RIGID ALUMINIUM PIPE

Transair®	ØD	C	Kg
ER01 L1 00	76	M8 / M10	0.168
ER01 L3 00	100	M8 / M10	0.259
ER01 L8 00	168	M8 / M10	0.540

To ensure good stability of the network, we recommend the use of at least 2 collars per pipe.

Ø  
16.5  
25  
40

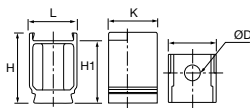

## SPACER

Transair®	ØD	H	H1	K	L	Kg
6697 00 03	11	49.5	44	34	33	0.021

This spacer, in association with a Transair® pipe clip, allows consistent alignment of pipes when different diameters of pipe are run concurrently in the same line.

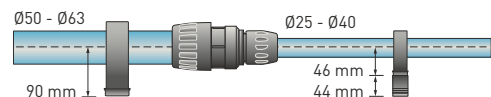

Ø  
16.5  
25  
40

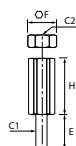

## CLIP ADAPTOR FOR THREADED ROD

Transair®	C1	C2	E	F	H	Kg
6697 00 02	M8 x 1.25	M10 x 1.5	16	16	22	0.056

The use of this adaptor facilitates the suspension of Transair® M10 threaded rod.

# FLEXIBLE HOSES

- ▮ Compressor outlets (absorption of vibration)
- ▮ To bypass obstacles and join different levels
- ▮ Expansion loops
- ▮ Max. working pressure for flexible hose used for compressed air:
  - ◆ 13 bar from -20°C to +60°C
  - ◆ 16 bar from -20°C to +45°C
- ▮ Working temperature: -20°C to +60°C
- ▮ Resistant to mineral and synthetic compressor oils
- ▮ Fire resistant (conforms to ISO 8030 standard for compressed air flexible hose)
- ▮ Flexible hose for vacuum: please consult us

Ø  
25  
40

Transair®	For use with Transair®	ØD1	ØD2	L (m)	Min. bend radius (mm)	Kg
1001E25 00 01	25	38	25	0.570	100	0.794
1001E25 00 03	25	38	25	1.500	100	1.700
1001E25 00 04	25	38	25	2.000	100	2.080
1001E40 00 02	40	54	40	1.150	400	2.200
1001E40 00 04	40	54	40	2.000	400	3.380
1001E40 00 05	40	54	40	3.000	400	4.000

Ø  
50  
63

Transair®	For use with Transair®	ØD1	ØD2	L (m)	Min. bend radius (mm)	Kg
1001E50 00 09	50	66	50	1.270	275	3.400
1001E50 00 04	50	66	50	2.000	280	4.310
1001E63 00 08	63	79	63	1.400	300	3.675
1001E63 00 05	63	79	63	3.000	650	7.500
1001E63 00 06	63	79	63	4.000	650	11.000

Ø  
76  
100  
168

Transair®	For use with Transair®	ØD1	ØD2	L (m)	Min. bend radius (mm)	Kg
FP01 L1 01	76	91	75	1.500	350	4.000
FP01 L1 02	76	91	75	2.000	350	8.800
FP01 L3 02	100	116	100	2.000	450	7.260
FP01 L3 03	100	116	100	3.000	450	19.900
FX01 L8 02	168	168	150	3.200	900	42.000

### Anti whip-lash strap



Prevents whip-lash should Transair® flexible hose be disconnected whilst under pressure.  
 Conforms to ISO 4414 safety standard.  
 Anti whip-lash strap includes 2 cables and 4 tensioning points.  
 6698 99 03 for Ø 25-40-50-63-76-100  
 6698 09 07 for Ø 168 only

# PIPE-TO-PIPE AND STUD CONNECTORS

- Quick connection
- Full bore design: consistent inner diameter for both pipe and connectors

- Interchangeable (applicable to Ø16.5, Ø25 and Ø40) and reusable
- Non-flammable materials (UL94-HB standard)

Ø  
16.5  
25  
40

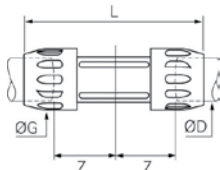

## PIPE-TO-PIPE CONNECTOR

Transair®	ØD	ØG	L	Z	Kg
6606 17 00	16.5	34	120.5	35	0.065
6606 25 00	25	44.5	151.5	48	0.130
6606 40 00	40	67	205	57	0.395

Ø  
50  
63

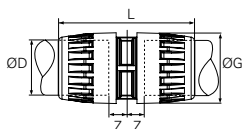

Transair®	ØD	ØG	L	Z	Kg
6606 50 00	50	80	171	25	0.719
6606 63 00	63	91	171	25	0.860

Ø  
76  
100  
168

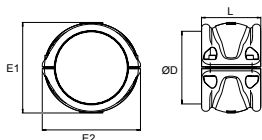

## PIPE-TO-PIPE CONNECTOR (CLAMP + CARTRIDGE)

Transair®	ØD	L	E1	E2	Kg
RR01 L1 00	76	146	103	132	1.033
RR01 L3 00	100	146	128	157	1.417
RR01 L8 00	168	139	212	230	2.570

Ø  
25  
40

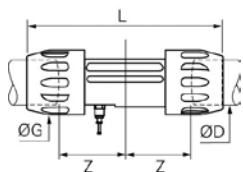

## PIPE-TO-PIPE CONNECTOR WITH VENT

Transair®	ØD	ØG	L	Z	Kg
6676 25 00	25	44.5	151.5	48	0.145
6676 40 00	40	67	205	57	0.412



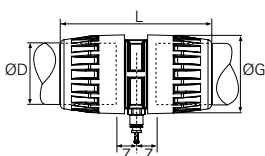

Models supplied with 1/4" threaded fitting and Ø8 mm push-in connection, complete with blanking plug.

Ø  
50  
63



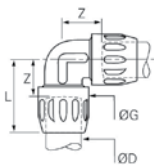

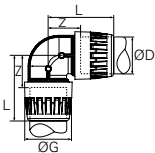

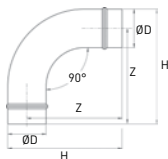
Transair®	ØD	ØG	L	Z	Kg
6676 50 00	50	80	171	25	0.748
6676 63 00	63	91	171	25	0.870

Models supplied with 1/4" threaded fitting and Ø8 mm push-in connection, complete with blanking plug.

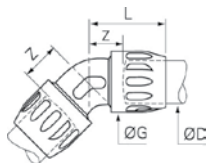
Ø	 	90° ELBOW					
		Transair®	ØD	ØG	L	Z	Kg
16.5		6602 17 00	16.5	34	58	31	0.065
25		6602 25 00	25	44.5	69.5	40	0.120
40		6602 40 00	40	67	103	62	0.410
Ø	 	90° ELBOW					
		Transair®	ØD	ØG	L	Z	Kg
50		6602 50 00	50	80	116	56	0.804
63		6602 63 00	63	91	124	61	0.970
Ø	 	90° ELBOW					
		Transair®	ØD	H	Z	Kg	
		RX02 L1 00	76	227	189	1.033	
100	RX02 L3 00	100	278	227	1.417		
168	RA02 L8 00	168	269	185	3.074		

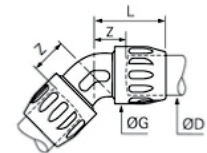
Use 2 connectors RR01 to connect 90° elbow RX12 and RA02 to Transair® aluminium pipe Ø76, Ø100 or Ø168.

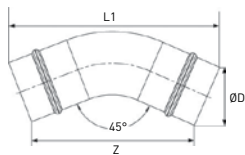
Ø	 	45° ELBOW					
		Transair®	ØD	ØG	L	Z	Kg
25		6612 25 00	25	44.5	61.5	32.5	0.115
40		6612 40 00	40	67	90	45	0.370
Ø	 	45° ELBOW					
		Transair®	ØD	ØG	L	Z	Kg
50		6612 50 00	50	80	98	38	0.771
63		6612 63 00	63	91	100	37	0.906
Ø	 	45° ELBOW					
		Transair®	ØD	L1	Z	Kg	
		RX12 L1 00	76	235.5	122	0.704	
100	RX12 L3 00	100	271.4	138	1.309		
168	RA12 L8 00	168	310.5	147.5	2.366		

Use 2 connectors RR01 to connect 45° elbows RX12 and RA12 to Transair® aluminium pipe Ø76, Ø100 or Ø168.



# PIPE-TO-PIPE AND STUD CONNECTORS

Ø  
16.5  
25  
40

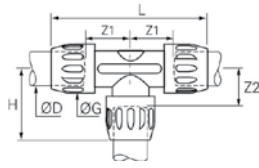

## EQUAL TEE

Transair®	ØD	G	H	L	Z1	Z2	Kg
6604 17 00	16.5	34	58	120.5	34	31	0.100
6604 25 00	25	44.5	67	151	48	40	0.185
6604 40 00	40	67	102	205	57	57	0.590

Ø  
50  
63

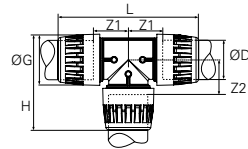

Transair®	ØD	G	H	L	Z1	Z2	Kg
6604 50 00	50	80	156	231	56	56	1.200
6604 63 00	63	91	122	245	61	61	1.435

Ø  
76  
100  
168

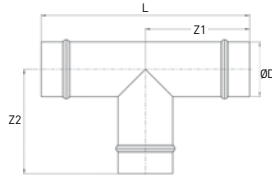

Transair®	ØD	L	Z1	Z2	Kg
RX04 L1 00	76	292	146	146	1.063
RX04 L3 00	100	312	156	136	1.787
RA04 L8 00	168	360	180	185	4.975

Use 3 connectors RR01 to connect equal tees RX04 and RA04 to Transair® aluminium pipe Ø76, Ø100 or Ø168.

Ø  
50  
63

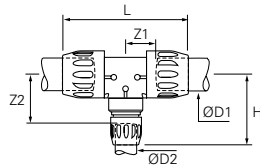

## REDUCING TEE

Transair®	ØD1	ØD2	ØG	H	L	Z1	Z2	Kg
6604 50 25	50	25	80	138	231	56	111	1.154
6604 50 40	50	40	80	157	231	56	107	1.264
6604 63 40	63	40	91	166	245	61	116	1.485
6604 63 50	63	50	91	177	252	61	117	1.644

Ø  
76  
100  
168

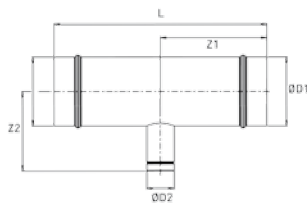

Transair®	ØD1	ØD2	L	Z1	Z2	Kg
RX24 L1 40	76	40	292	146	105	1.020
RX24 L1 50	76	50	292	146	160	0.895
RX24 L1 63	76	63	292	146	164	1.091
RX24 L3 40	100	40	312	156	118	1.586
RX24 L3 50	100	50	312	156	173	1.740
RX24 L3 63	100	63	312	156	177	1.672
RX04 L3 L1	100	76	312	156	136	1.637
RA04 L8 63	168	63	360	180	220	3.104
RA04 L8 L1	168	76	360	180	185	3.145
RA04 L8 L3	168	100	360	180	185	3.169

## INCREASER TEE

Transair®	ØD1	ØD2	L	Z1	Z2	Kg
RA04 63 L1	63	76	348	174	142	1.855
RA04 L1 L3	76	100	322	161	149	2.487
RA04 L3 L8	100	168	388	194	161	4.240

Use connectors RR01 to connect RX24 and RA04 tees to Transair® aluminium pipe Ø76, Ø100 or Ø168 and Transair® pipe-to-pipe connectors to connect Transair® aluminium pipe Ø40, Ø50 or Ø63 mm.

Ø  
76  
100

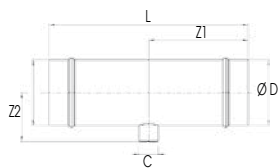

**THREADED TEE**

Transair®	ØD	C	L	Z1	Z2	Kg
RX23 L1 04	76	G1/2	290	145	63	0.892
RX23 L3 04	100	G1/2	310	155	76	1.564

Use 2 connectors RR01 to connect threaded tee RX23 to Transair® aluminium pipe Ø76 or Ø100.

Ø  
63  
76  
100  
168

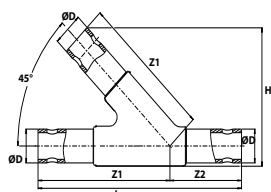

**EQUAL Y**

Transair®	ØD	H	L	Z1	Z2	Kg
RA26 63 00	63	257	432	280	152	2.825
RA26 L1 00	76	254	366	260	106	3.238
RA26 L3 00	100	290	396	280	116	3.540
RA26 l8 00	168	401	476	350	126	11.717

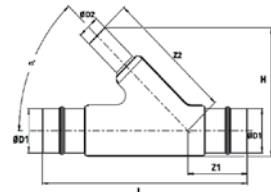

**REDUCER Y**

Transair®	ØD1	ØD2	H	L	Z1	Z2	Kg
RA26 L1 40	76	40	220	366	230	106	2.603
RA26 L1 50	76	50	259	366	280	106	2.820
RA26 L1 63	76	63	262	366	280	106	3.013
RA26 L3 63	100	63	276	396	280	116	3.007
RA26 L3 L1	100	76	281	396	280	116	3.270
RA26 L8 L3	168	100	359	392	330	86	6.726

Use RR01 connectors to connect Y RA26 to Transair® aluminium pipe Ø76, Ø100 or Ø168 and a Transair® pipe-to-pipe connector to connect Y RA26 to Transair® aluminium pipe Ø40, Ø50 or Ø63.

Ø  
40  
50  
63  
76  
100  
168

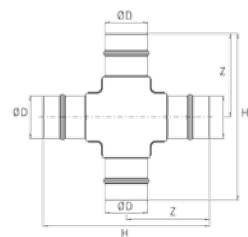

**EQUAL CROSS**

Transair®	ØD	H	Z	Kg
RA07 40 00	40	252	112	0.650
RA07 50 00	50	356	161	1.130
RA07 63 00	63	364	167.5	2.100
RA07 L1 00	76	298	149	2.570
RA07 L3 00	100	322	161	3.671
RA07 L8 00	168	382	191	7.050

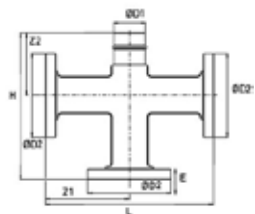

**3 FLANGED CROSS (EN-ISO)**

Transair®	ØD1	DN	ØD2	H	L	E	Z1	Z2	Kg
RA07 L1 03 45	76	80	200	356	414	24.6	201.4	149	9.240
RA07 L3 03 45	100	100	220	380	438	24.6	213.4	161	11.520
RA07 L8 03 45	168	150	285	448.7	515	26.1	257.7	191	19.230

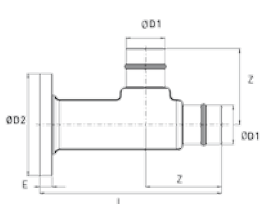

**1 FLANGED TEE (EN-ISO)**

Transair®	ØD1	DN	ØD2	L	E	Z	Kg
RA44 L1 00 45	76	80	200	356	24.6	149	4.275
RA44 L3 00 45	100	100	220	380	24.6	161	5.530
RA44 L8 00 45	168	150	285	448.7	26.1	191	10.120

Use connectors RR01 to connect RA07 crosses and RA44 flange tees to Transair® aluminium pipe Ø76, Ø100 or Ø168 and Transair® pipe-to-pipe connectors to connect to Transair® aluminium pipe Ø40, Ø50 or Ø63.

# PIPE-TO-PIPE AND STUD CONNECTORS

Ø  
16.5  
25  
40

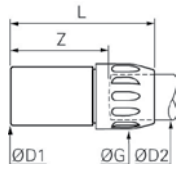

## PLUG-IN REDUCER

Transair®	ØD1	ØD2	ØG	Z	L	Kg
6666 17 25	25	16.5	34	51	77	0.052
6666 25 40	40	25	44.5	71	100.5	0.126

Ø  
50  
63

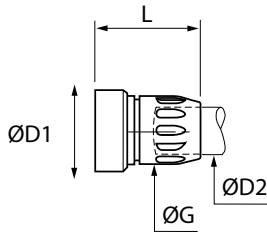

Transair®	ØD1	ØD2	ØG	L	Kg
6666 25 50	50	25	45	97	0.210
6666 40 50	50	40	67	116	0.317
6666 40 63	63	40	67	120	0.373
6666 50 63	63	50	80	125	0.520

Ø  
76  
100  
168

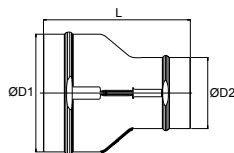

Transair®	ØD1	ØD2	L	Kg
RX64 L1 50	76	50	220	0.530
RX64 L1 63	76	63	230	0.584
RX64 L3 50	100	50	343	1.290
RX64 L3 63	100	63	250	0.850
RX66 L3 L1	100	76	192.5	0.702
RA66 L8 L1	168	76	210	1.388
RA66 L8 L3	168	100	210	1.502

Use 1 connector RR01 to connect plug-in reducer RX64, RX66 and RA66 to Transair® aluminium pipe Ø76 or Ø100 and 1 pipe-to-pipe connector to connect to Transair® aluminium pipe Ø50 or Ø63.

Ø  
16.5  
25  
40

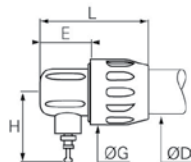

## VENTED END CAP

Transair®	ØD	E	ØG	H	L	Kg
6625 17 00	16.5	25.5	34	45.5	62.5	0.145
6625 25 00	25	33	45	47	75	0.061
6625 40 00	40	34.5	67	54	98.5	0.180

Model Ø16.5: supplied with Ø6mm plug  
Models Ø25 and Ø40: supplied with Ø8mm plug

Ø  
50  
63

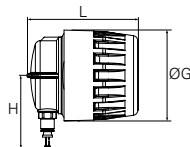

Transair®	ØD	ØG	H	L	Kg
6625 50 00	50	80	67	107	0.423
6625 63 00	63	91	72.5	111	0.496

Supplied with Ø8mm plug

Ø  
76  
100  
168

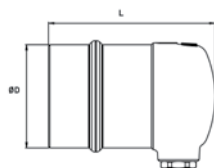

Transair®	ØD	L	Kg
RA25 L1 04	76	123	0.642
RA25 L3 04	100	123	0.929
RA25 L8 04	168	116	1.200

Use 1 connector RR01 to connect end cap RA25 to Transair® aluminium pipe Ø76, Ø100 or Ø168.  
Supplied with 1/2" threaded plug.

Ø  
16.5  
25  
40

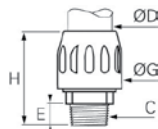

**MALE STUD FITTING - BSP TAPER**

Transair®	ØD	C	E	ØG	H	Kg
6605 17 13	16.5	R1/4	9.5	34	62.5	0.100
6605 17 21	16.5	R1/2	12	34	65	0.110
6605 25 21	25	R1/2	15	44.5	70	0.166
6605 25 27	25	R3/4	16	44.5	71	0.176
6605 25 34	25	R1"	16	44.5	71	0.230
6605 40 34	40	R1"	16	67	111	0.585
6605 40 42	40	R1"1/4	19.5	67	111	0.510
6605 40 49	40	R1"1/2	24.5	67	115	0.625

Ø  
50  
63

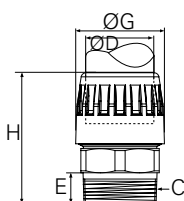

Transair®	ØD	C	E	ØG	H	Kg
6605 50 49	50	R1"1/2	22.6	80	119	1.039
6605 50 48	50	R2"	26.9	80	125	1.022
6605 63 48	63	R2"	26.9	91	118.5	1.095
6605 63 47	63	R2"1/2	31.5	91	130.5	1.474

Ø  
25  
40  
50

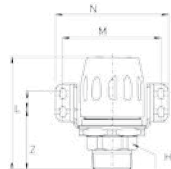

**MALE STUD FITTING WITH FIXING PLATE - BSP TAPER**

Transair®	ØD	C	Hex	L	M	N	Z	Kg
6615 25 21	25	R1/2	27	87	87	102	60	0.440
6615 25 27	25	R3/4	27	87	87	102	60	0.480
6615 25 34	25	R1"	34	91	87	102	64	0.570
6615 40 42	40	R1"1/4	50	121	105	120	75	0.985
6615 40 49	40	R1"1/2	50	121	105	120	75	1.098
6615 50 49	50	R1"1/2	50	127	116.5	132	67	1.316
6615 50 48	50	R2"	60	131	116.5	132	71	1.331

Ø  
16.5  
25  
40  
50  
63

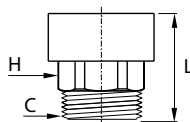

**MALE THREADED NUT - BSP TAPER**

Transair®	ØD	C	Hex	L	Kg
6611 17 21	16.5	R1/2	23	41	0.150
6611 25 21	25	R1/2	27	43	0.172
6611 25 27	25	R3/4	27	45	0.210
6611 25 34	25	R1"	36	49	0.250
6611 40 34	40	R1"	41	53	0.410
6611 40 42	40	R1"1/4	50	61	0.480
6611 40 49	40	R1"1/2	50	61	0.500
6611 40 48	40	R2"	60	65	0.620
6611 50 49	50	R1"1/2	50	79	0.724
6611 50 48	50	R2"	60	85	0.788
6611 63 48	63	R2"	70	82	0.900
6611 63 47	63	R2"1/2	80	86	1.200

6611 male threaded stud fittings can be used with all Transair® pipe-to-pipe stud connectors (as a replacement for the standard nuts) for Ø16.5 to Ø63mm.

# PIPE-TO-PIPE AND STUD CONNECTORS

Ø  
16.5  
25  
40  
50  
63

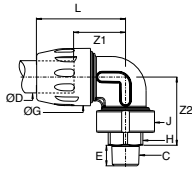

## MALE STUD 90° ELBOW - BSP TAPER

Transair®	ØD	C	E	ØG	H	J	L	Z1	Z2	Kg
6609 17 13	16.5	R1/4	11.9	34	17	34	58	31	41	0.104
6609 17 21	16.5	R1/2	16	34	23	34	58	31	46.5	0.133
6609 25 21	25	R1/2	16	44.5	27	45.5	69.5	40.5	53	0.223
6609 25 27	25	R3/4	17.4	44.5	27	45.5	69.5	40.5	53	0.238
6609 25 34	25	R1"	20.3	44.5	36	45.5	69.5	40.5	55	0.295
6609 40 34	40	R1"	20.3	67	41	68.5	103	62	75	0.684
6609 40 42	40	R1"1/4	22.6	67	50	68.5	103	62	81	0.792
6609 40 49	40	R1"1/2	22.6	67	50	68.5	103	62	81	0.816
6609 40 48	40	R2"	26.9	67	60	68.5	103	62	81	0.900
6609 50 49	50	R1"1/2	22.6	80	50	80	116	56	97	1.290
6609 50 48	50	R2"	26.9	80	60	80	116	56	99	1.355
6609 63 48	63	R2"	26.9	91	70	91	124	61	105	1.452
6609 63 47	63	R2"1/2	30.2	91	80	91	124	61	106	1.831

Ø  
25  
40  
50  
63

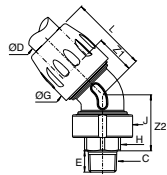

## MALE STUD 45° ELBOW - BSP TAPER

Transair®	ØD	C	E	ØG	H	J	L	Z1	Z2	Kg
6619 25 21	25	R1/2	16.0	44.5	27	45.5	61.5	32.5	42	0.212
6619 25 27	25	R3/4	17.4	44.5	27	45.5	61.5	32.5	42	0.227
6619 25 34	25	R1"	20.3	44.5	36	45.5	61.5	32.5	44	0.285
6619 40 34	40	R1"	20.3	67	41	68.5	94	45	58.5	0.645
6619 40 42	40	R1"1/4	22.6	67	50	68.5	94	45	64	0.755
6619 40 49	40	R1"1/2	22.6	67	50	68.5	94	45	64	0.780
6619 40 48	40	R2"	26.9	67	60	68.5	94	45	64	0.860
6619 50 49	50	R1"1/2	22.6	80	50	80	98	38	80	1.267
6619 50 48	50	R2"	26.9	80	60	80	98	38	82	1.312
6619 63 48	63	R2"	26.9	91	70	91	100	37	81	1.452
6619 63 47	63	R2"1/2	30.2	91	80	91	100	37	82	1.831

Ø  
16.5  
25  
40

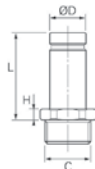

## MALE ADAPTOR - BSP TAPER

Transair®	ØD	C	L	H	Kg
6621 17 21	16.5	R1/2	42	5	0.610
6621 25 21	25	R1/2	49	7	0.109
6621 25 27	25	R3/4	49	7	0.111
6621 25 34	25	R1"	52	7	0.187
6621 40 42	40	R1"1/4	73.7	8	0.358
6621 40 49	40	R1"1/2	75.7	10	0.452

Ø  
76

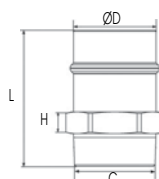

Transair®	ØD	C	L	H	Kg
RR05 L1 20	76	R2"1/2	125	20	1.968
RR05 L1 24	76	R3"	133	25	3.100

Use 1 connector RR01 to connect male adaptor RR05 to Transair® aluminium pipe Ø76.

Ø  
25  
40



**MANIFOLD**

Transair®	ØD	ØG	L	L1	L2	N	Z	E	S	Kg
6651 25 12 04	25	44.5	271	155	25	35	107	G3/4"	G3/8"	1.045
6651 40 12 04	40	67	400	210	30	50	150	G1"1/4	G1/2"	2.285

4 ports manifold, supplied with 4 Ø12mm plugs

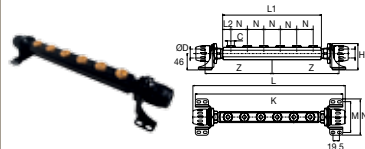

Transair®	ØD	C	L	L1	L2	K	N	Z	H	M	Kg
6652 25 21 06	25	G1/2	463	300	25	448	50	204	74	86.5	2.300
6652 40 21 06	40	G1/2	526	310	30	469	50	217	83	104.5	3.800

6 ports manifold, supplied with 6 G1/2" plugs

Ø  
63  
76  
100  
168

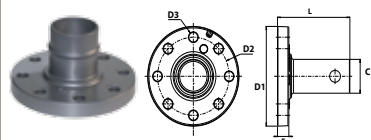

**CIRCULAR ALUMINIUM FLANGE EN-ISO**

Transair®	ØD	DN	ØD1	ØD2	ØD3	E	L	Kg
RA30 63 00	63	65	185	145	18	23	146.5	1.636
RA30 L1 00	76	80	200	160	18	24.6	106.8	1.924
RA30 L3 00	100	100	220	180	18	24.6	106.8	2.277
RA31 L8 00	168	150	279	240	22.7	25.4	127.4	3.673
RA30 L8 K2	168	200	340	295	22	29.3	199.3	7.246

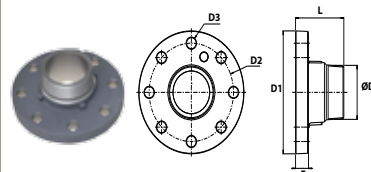

**CIRCULAR ALUMINIUM FLANGE EN-ISO THREADED**

Transair®	C	DN	ØD1	ØD2	ØD3	E	L	Kg
RA33 L1 24	R3"	80	200	160	18	24,6	91,6	2,226
RA33 L3 24	R3"	100	220	180	18	24,6	91,6	2,644

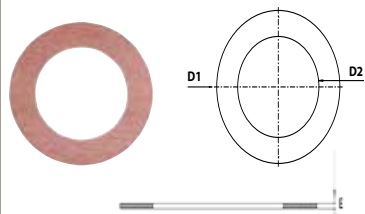

**GASKET FOR ALUMINIUM FLANGE**

Transair®	DN	for Circular Flange	ØD1	ØD2	E	kg
EW05 63 00	65	RA30 63 00	124	73	3	0.028
EW05 L1 00	80	RA30 L1 00 - RA33 L1 24	142	89	3	0.033
EW05 L3 00	100	RA30 L3 00 - RA33 L3 24	162	115	3	0.052
EW05 L8 00	150	RA31 L8 00	218	169	3	0.075
EW05 K2 00	200	RA30 L8 K2	273	220	3	0.110



**BOLT KITS FOR ALUMINIUM FLANGE**

Transair®	C	L	Number of Bolts	Kg
EW06 00 03	M16	90	x 8	1.820
EW06 00 08	M20	90	x 4	1.490

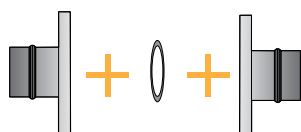

**SELECTION TABLE FOR GASKETS AND BOLT KITS FOR FLANGE / FLANGE ASSEMBLY**

Transair®	ØD/C	DN	Gasket Part Number	Bolt Kit Part Number	Number of Kits	Max. Tightening Torque in N.m (C)
RA30 63 00	63	65	EW05 63 00	EW06 00 03	1 kit	80
RA30 L1 00	76	80	EW05 L1 00	EW06 00 03	1 kit	80
RA33 L1 24	R3"	80	EW05 L1 00	EW06 00 03	1 kit	80
RA33 L3 24	R3"	100	EW05 L3 00	EW06 00 03	1 kit	80
RA30 L3 00	100	100	EW05 L3 00	EW06 00 03	1 kit	80
RA31 L8 00	168	150	EW05 L8 00	EW06 00 08	2 kits	200
RA30 L8 K2	168	200	EW05 K2 00	EW06 00 08	3 kits	200

These kits can be used for the assembly of crosses RA07 and RA44 of page 33.

# BALL VALVES AND BUTTERFLY VALVES

Transair® ball valves and butterfly valves placed regularly throughout the network and at key locations, such as compressor outlets and upstream of pneumatic tools, allow ease of system isolation and pipe work reconfiguration / maintenance.

- ▮ Quick connection
- ▮ These valves are silicone-free.

Ø  
16.5  
25  
40  
50  
63

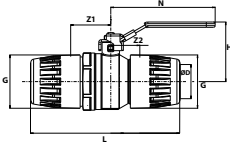

## LOCKABLE DOUBLE BALL VALVE

Transair®	ØD	ØG	L	N	H	Z1	Z2	Kg
4092 17 00	16.5	34	123	96	51	29	43	0.330
4092 25 00	25	44	155	117	73	41	57	0.895
4092 40 00*	40	67	205	141	76	57	58	1.735
4092 50 00*	50	80	224	156	90	43	60	1.690
4092 63 00*	63	91	269	200	109	66	77	2.605

\*Models with CE marking

Ø  
63  
76  
100  
168

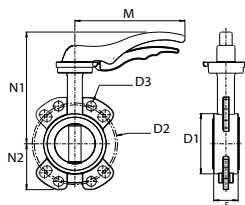

## LOCKABLE BUTTERFLY VALVE

Transair®	ØD	DN	ØD1	ØD2	ØD3	M	N1	N2	E	Kg
VR02 63 00	63	65	102	145	18	170	186	69	46	2.400
VR02 L1 00	76	80	118	160	18	206	219	90	46	3.200
VR02 L3 00	100	100	150	180	18	206	239	106	52	4.300
VR02 L8 00	168	150	205	240	23	285	290	131	56	7.800

Models with CE marking. NBR seal. EW06 bolt kits are not supplied for valve/flanges assembly. The butterfly valves do not require additional ring when connected to circular flanges. Suitable for flanges according to EN 1092-1 - PN 16.

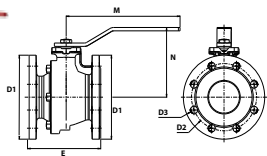

## BALL VALVE

Transair®	ØD	DN	ØD1	ØD2	ØD3	M	N	E	Kg
VR01 L1 00	76	80	200	160	18	280	165	180	15.500
VR01 L3 00	100	100	220	180	18	360	180	190	18.500
VR01 L8 00	168	150	285	241	22	520	243	210	38.500

Models with CE marking. EW05 seals (see page 37) and EW06 bolt kits are not supplied for flange/flange assembly. Suitable for flanges according to EN 1092-1 - PN 16.

## BOLT KIT FOR BALL VALVE AND ALUMINIUM FLANGE

Transair®	C	L	Number of Bolts	Kg
EW06 00 02	M16	75	x 8	1.824
EW06 00 07	M16	130	x 8	2.287
EW06 00 09	M20	140	x 8	3.864
EW06 00 15	3/4 - 10UNC	76	x 8	2.237
EW06 00 17	M16	70	x 8	1.785

## BOLT KITS FOR ASSEMBLY ALUMINIUM FLANGE / VALVE / ALUMINIUM FLANGE

Transair®	ØD	DN	Flange Part Number	Bolt Kit Part Number	Bolt Kit Quantity	Max. Tightening Torque N. m
VR02 63 00	63	65	RA30 63 00	EW06 00 07	1 kit	80
VR02 L1 00	76	80	RA30 L1 00 - RA33 L1 24	EW06 00 07	1 kit	80
VR02 L3 00	100	100	RA30 L3 00 - RA33 L3 24	EW06 00 07	1 kit	80
VR02 L8 00	168	150	RA31 L8 00	EW06 00 09	1 kit	200
VR01 L1 00	76	80	RA30 L1 00 - RA33 L1 24	EW06 00 17	2 kits	80
VR01 L3 00	100	100	RA30 L3 00 - RA33 L3 24	EW06 00 02	2 kits	80
VR01 L8 00	168	150	RA31 L8 00	EW06 00 15	2 kits	200

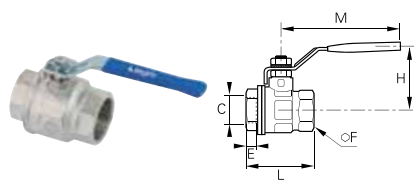

**DOUBLE FEMALE BALL VALVE**

Transair®	C	DN	Pmax. (bar)	E	F	H	L	M	Kg
VR03 00 02	G1/4	10	30	11.4	20	43	51.5	98	0.157
VR03 00 03	G3/8	10	30	11.4	20	43	51.5	98	0.141
VR03 00 04	G1/2	15	30	13.5	25	47	55	98	0.204
VR03 00 06	G3/4	20	30	12.5	31	58	57.5	122	0.310
VR03 00 08	G1"	25	30	15	38	60	69.5	122	0.460
VR03 00 10*	G1"1/4	32	25	17	48	77	81.5	153	0.751
VR03 00 12*	G1"1/2	40	25	28	54	83	95	153	1.100
VR03 00 16*	G2"	50	25	22	66	95	113	162	1.644
VR03 00 20*	G2"1/2	61	16	24	84	95	132.5	255	2.979

\*Models with CE marking

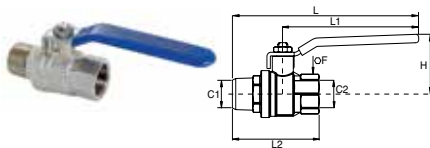

**BALL VALVE - MALE BSP TAPER, FEMALE BSP PARALLEL**

Transair®	C1	C2	DN	Pmax. (bar)	F	H	L	L1	L2	Kg
VR04 00 04	R1/2	G1/2	15	40	25	43	140.5	100	70	0.230
VR04 00 06	R3/4	G3/4	20	40	31	50	164.5	120	76.5	0.360
VR04 00 08	R1"	G1"	25	40	40	54	172	120	92.5	0.623
VR04 00 10*	R1"1/4	G1"1/4	32	40	49	73	217.5	158	106	0.965
VR04 00 12*	R1"1/2	G1"1/2	40	40	54	79	220	158	113	1.213
VR04 00 16*	R2"	G2"	50	40	68.5	86	230.5	158	133	1.983
VR04 00 20*	R21/2	G2"1/2	65	30	85	132	357.5	255	180.5	3.600

\*Models with CE marking

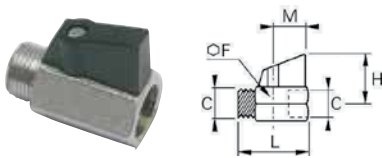

**MINI BALL VALVE - MALE / FEMALE, BSP TAPER**

Transair®	C	DN	F	H	L	M	Kg
4981 10 21TR	R1/2	10	25	31	46	20.5	0.138

Max. working pressure: 10 bar

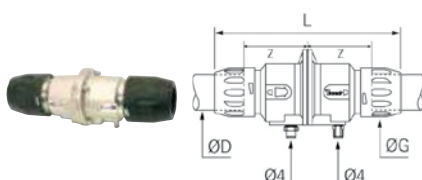

**REMOTE CONTROL SHUT-OFF VALVE**

Transair®	ØD	G	L	Z	Kg
4230 00 40	40	67	261	85	1.817

Min. working pressure: 4 bar - Max. working pressure: 13 bar  
 The Transair® remote control shut-off valve is supplied with a plugged vent hole. This allows venting of the downstream network, after closing the valve.

Ø 40



**PILOT KIT**

Transair®	H	K	K1	L	Kg
4299 03 01	145	106	70	82	0.788

This pilot kit comprises: pneumatic ON-OFF switch (maximum 10 bar operating pressure), twin 4 mm OD polyurethane tube (length 10m) and plastic box.



# QUICK ASSEMBLY DIRECT FEED BRACKETS

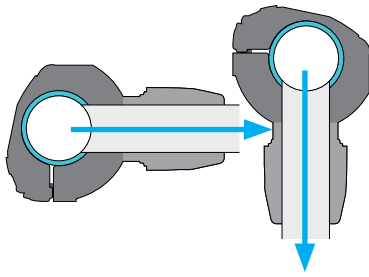

For rigid drops with horizontal take off or for all types of air supply with rigid pipe or flexible hose on an installation which incorporates an efficient air dryer.

- Optimum flow
- Compact
- Well adapted for most OEM applications and for use with neutral gases
- Quick installation without any cutting of pipe

Ø  
25  
40  
50  
63

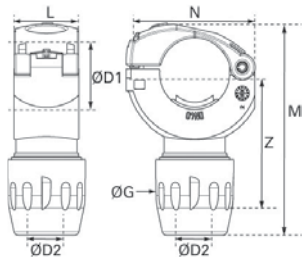

## QUICK ASSEMBLY DIRECT FEED BRACKET

Transair®	ØD1	ØD2	M	G	L	N	Z	Kg
RA69 25 17	25	16.5	94	34	37	52	47.5	0.085
RA69 40 25	40	25	117	45	37	74	63	0.146
RA69 50 25	50	25	125	45	37	86	66	0.163
RA69 63 25	63	25	137	45	37	100	72	0.165

To drill Transair® aluminium pipe, use drilling tools 6698 02 01 and 6698 02 02.

Ø  
76  
100  
168

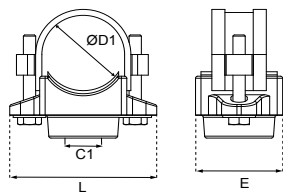

Transair®	ØD1	C1	E	L	Kg
RR61 L1 08	76	G1"	80	137	2.000
RR61 L1 16	76	G2"	80	137	1.900
RR61 L3 08	100	G1"	90	158	3.400
RR61 L3 16	100	G2"	90	158	1.800

To drill Transair® aluminium pipe, use drilling tool EW09.  
Supplied without plug

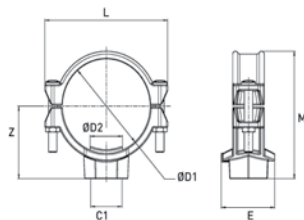

Transair®	ØD1	ØD2	C1	E	L	M	Z	Kg
RR63 L8 12	168	51	G1" 1/2	90	235	231	130	3.400
RR63 L8 16	168	64	G2"	103	235	231	130	3.500
RR63 L8 20	168	70	G2" 1/2	112	235	231	130	4.000
RR63 L8 24	168	90	G3"	132	240	231	130	4.700

To drill Transair® aluminium pipe, use drilling tool EW09.  
Supplied without plug

Ø  
25  
40  
50  
63

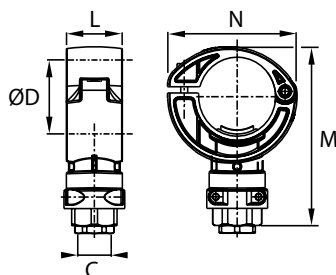

## QUICK ASSEMBLY DIRECT FEED MINI-BRACKET WITH FEMALE THREAD

Transair®	ØD	C	L	M	N	Kg
RA65 25 04	25	G1/2	37	86	52	0.176
RA65 40 04	40	G1/2	37	100	74	0.198
RA65 50 04	50	G1/2	37	115	86	0.206
RA65 50 08	50	G1"	37	129	86	0.326
RA65 63 04	63	G1/2	37	126	100	0.258
RA65 63 08	63	G1"	37	140	100	0.460

Supplied with blanking plug  
To drill Transair® aluminium pipe, use drilling tools 6698 02 01 and 6698 02 02.

# QUICK ASSEMBLY BRACKETS

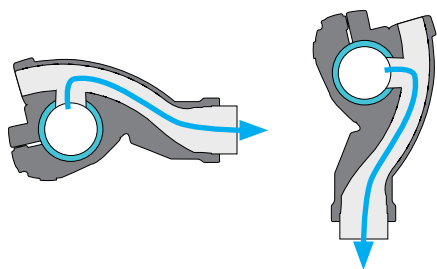

New generation quick assembly brackets are recommended for vertical or horizontal take-offs, using either rigid pipe or flexible hose.

- Integral water retention device
- Very high flow
- Quick installation without any cutting of pipe

		QUICK ASSEMBLY BRACKETS									
Ø		Transair®	ØD1	ØD2	M	ØG	L	N	Z	Kg	
Ø 25 40			6662 25 17	25	16.5	140	35	36	63.5	82	0.109
			6662 25 00	25	25	134	45	36	63.5	74	0.124
			6662 40 17	40	16.5	154	35	37.5	76.5	89	0.138
			6662 40 25	40	25	150	45	37.5	76.5	82	0.145
To drill Transair® aluminium pipe, use drilling tools 6698 02 01 and 6698 02 02.											
Ø		QUICK ASSEMBLY BRACKETS									
Ø		Transair®	ØD1	ØD2	M	G	L	N	Z	Kg	
Ø 50 63			6662 50 25	50	25	132	45	37.5	98	58	0.155
			6662 63 25	63	25	147	45	37	105	65	0.174
To drill Transair® aluminium pipe, use drilling tool 6698 02 01.											
Ø		QUICK ASSEMBLY BRACKET WITH FEMALE THREAD									
Ø		Transair®	ØD1	C	L	M	N	Kg			
Ø 25 40			6661 25 21	25	G1/2	36	129	65	0.186		
			6661 40 21	40	G1/2	37.5	143	76.5	0.205		
			6661 40 27	40	G3/4	37.5	143	76.5	0.289		
Supplied with blanking plug To drill Transair® aluminium pipe, use drilling tools 6698 02 01 and 6698 02 02.											
Ø		QUICK ASSEMBLY BRACKET WITH FEMALE THREAD									
Ø		Transair®	ØD1	C	L	M	N	Kg			
Ø 50 63			6661 50 21	50	G1/2	37	121	96	0.217		
			6661 50 27	50	G3/4	37	130	96	0.246		
			6661 63 21	63	G1/2	37	136.5	103	0.271		
			6661 63 27	63	G3/4	37	145.5	103	0.342		
Supplied with blanking plug To drill Transair® aluminium pipe, use drilling tool 6698 02 01.											

# QUICK ASSEMBLY BRACKETS WITH BALL VALVE OR COUPLER

Quick assembly brackets with pre-assembled ball valve or coupler allow time savings during installation.

Ø  
25  
40  
50  
63

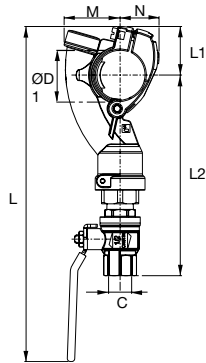

## QUICK ASSEMBLY BRACKET WITH PRE-ASSEMBLED BALL VALVE - BSP PARALLEL

Transair®	ØD	C	L	L1	L2	M	N	Kg
6669 25 21	25	G1/2	256	32	155	40	23	0.43
6669 40 21	40	G1/2	271	39	162	45	31	0.45
6669 40 27	40	G3/4	304	39	176	45	31	0.62
6669 50 21	50	G1/2	249	46	133.5	87	32	0.467
6669 50 27	50	G3/4	282	46	147.5	94	32	0.621
6669 63 21	63	G1/2	265	55	141	87	38	0.67
6669 63 27	63	G3/4	297	55	155	94	38	0.78

Ø  
25  
40

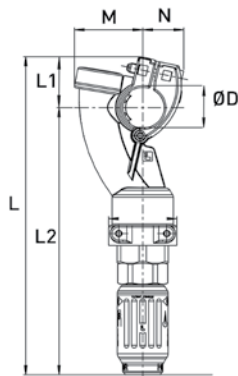

## QUICK ASSEMBLY BRACKET WITH PRE-ASSEMBLED BALL VALVE - BSP PARALLEL

Transair®	ØD	L	L1	L2	M	N	Profile	Bore (mm)	Kg
6660 25 U1	25	198	32	166	40	24	ISO B	5.5	0.302
6660 25 U2	25	205	32	173	40	24	ISO B	8	0.334
6660 25 E4	25	205	32	173	40	24	EURO	7.2	0.327
6660 25 A1	25	195	32	164	40	24	ARO	5.5	0.344
6660 40 U1	40	213	40	173	45	31	ISO B	5.5	0.332
6660 40 U2	40	219	40	180	45	31	ISO B	8	0.357
6660 40 E4	40	219	40	180	45	31	EURO	7.2	0.355
6660 40 A1	40	210	40	171	45	31	ARO	5.5	0.358

## Drilling Tool Selection for Quick Assembly Brackets

Further information on page 48 of this catalogue

Transair®	Tool Part Number
RA69 25 17	6698 02 02
RA69 40 25 RA69 50 25 RA69 63 25	6698 02 01 EW09 00 22
RR61 L1 08	EW09 00 30
RR61 L1 16	EW09 00 51
RR61 L3 08	EW09 00 30
RR61 L3 16	EW09 00 51
RR63 L8 12	EW09 00 51
RR63 L8 16	EW09 00 64
RR63 L8 20	EW09 00 70
RR63 L8 24	EW09 00 90

Transair®	Tool Part Number
RA65 25 04	6698 02 02
RA65 50 04 RA65 50 08 RA65 63 04 RA65 63 08	6698 02 01 EW09 00 22
6662 25 17 6662 25 00	6698 02 02
6662 40 17 6662 40 25 6662 50 25 6662 63 25	6698 02 01 EW09 00 22

Transair®	Tool Part Number
6661 25 21	6698 02 02
6661 40 21 6661 40 27 6661 50 21 6661 50 27 6661 63 21 6661 63 27 6661 63 21 6661 63 27	6698 02 01 EW09 00 22



# I PRESSURISED SYSTEM OUTLETS

I Ideal for fast assembly of new pressurised outlets, without venting the compressed air network.

I The drilling tool can be used with most standard drills.

We recommend, however, that the pipe work network is drained prior to the addition of an outlet.

Thanks to the lateral dismantling capability of Transair® pipe and the use of quick assembly brackets, this operation can be completed very quickly (less than 7 min. for a new outlet) and guarantees the interior cleanliness of the circuit.

Ø

25

40

50

63

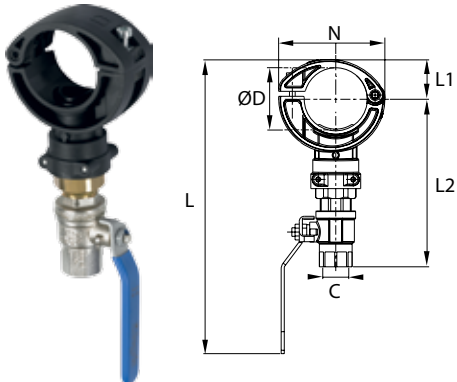

### PRESSURISED SYSTEM OUTLET

Transair®	ØD	C	L	L1	L2	N	Kg
EA98 06 01	25	G1/2	176	14	92	60	0.38
EA98 06 02	40	G1/2	216	46	99	84	0.657
EA98 06 04	50	G1/2	237	32	135	86	0.433
EA98 06 03	63	G1/2	249	39	140	100	0.61

Bracket with ball valve BSP G1/2"

Ø

13

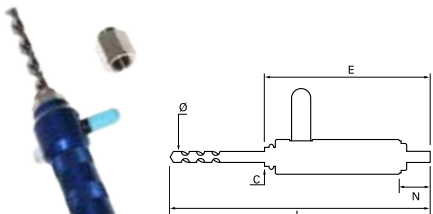

### PRESSURISED SYSTEM DRILLING TOOL

Transair®	C	ØD	E	L	N	Kg
EA98 06 00	G1/2	13	154	330	30.5	0.820

Supplied with a spacer.

## Drilling Tool Selection for Quick Assembly Brackets

Further information on page 48 of this catalogue

Transair®	Tool Part Number
6669 25 21	6698 02 02
6669 40 21	6698 02 01 EW09 00 22
6669 40 27	
6669 50 21	
6669 50 27	
6669 63 21	6698 02 01 EW09 00 22
6669 63 27	
6660 25 U1	6698 02 02
6660 25 U2	
6660 25 E4	
6660 25 A1	
6660 40 U1	6698 02 01 EW09 00 22
6660 40 U2	
6660 40 E4	
6660 40 A1	

Transair®	Tool Part Number
EA98 06 01	EA98 06 00
EA98 06 02	6698 02 01
EA98 06 04	EW09 00 22
EA98 06 03	



# WALL BRACKETS

- 1, 2 or 3 ports
- For wall or machine mounting
- Secondary outlet G1/4" for exhaust
- Supplied with end-caps

Full silicone-free range

Ø  
16.5  
25

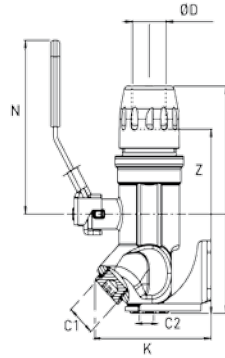

## 1 PORT 45° WALL BRACKET WITH BALL VALVE - BSP PARALLEL

Transair®	ØD	C1	C2	H	K	N	Z	Kg
6678 17 21	16.5	G1/2	G1/4	130	87	96	104	0.879
6678 25 21	25	G1/2	G1/4	153	86	117	124	1.502

Supplied with G1/2" end cap  
Lockable

Ø  
16.5  
25

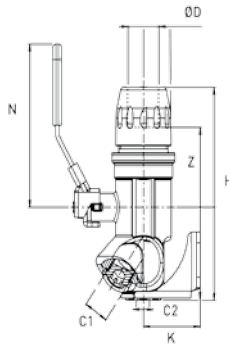

## 2 PORT 45° WALL BRACKET WITH BALL VALVE - BSP PARALLEL

Transair®	ØD	C1	C2	H	K	N	Z	Kg
6693 17 21	16.5	G1/2	G1/4	129	84.5	96	103	0.879
6693 25 21	25	G1/2	G1/4	152	84.5	117	104	1.467

Supplied with G1/2" end caps  
Lockable

Ø  
25

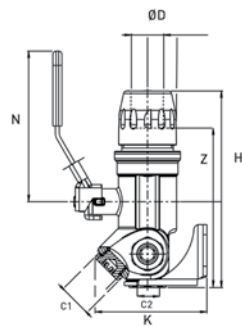

## 3 PORT WALL BRACKET WITH BALL VALVE - BSP PARALLEL

Transair®	ØD	C1	C2	H	K	N	Z	Kg
6637 25 21	25	G1/2	G1/4	153	84.5	117	124	1.449

Supplied with G1/2" end caps  
Lockable

Ø  
16.5  
25

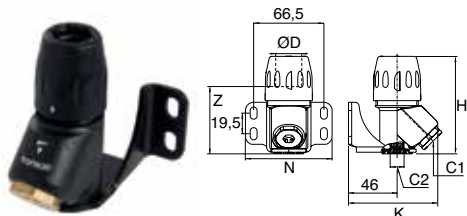

**1 PORT 45° WALL BRACKET - BSP PARALLEL**

Transair®	ØD	C1	C2	H	K	N	Z	Kg
6639 17 21	16.5	G1/2	G1/4	89.5	84.5	82	63.5	0.530
6639 25 21	25	G1/2	G1/4	92.5	84.5	82	63.5	0.535

Supplied with G1/2" end cap

Ø  
16.5  
25

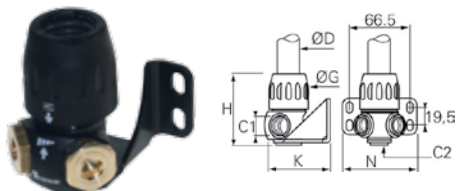

**2 PORT 90° WALL BRACKET - BSP PARALLEL**

Transair®	ØD	C1	C2	ØG	H	K	N	Kg
6681 17 21	16.5	G1/2	G1/4	34	65	74.5	82	0.422
6681 25 21	25	G1/2	G1/4	44.5	81	74.5	82	0.460

Supplied with G1/2" end caps

Ø  
16.5  
25

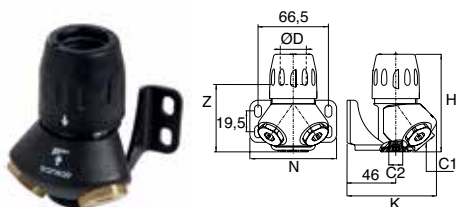

**2 PORT 45° WALL BRACKET - BSP PARALLEL**

Transair®	ØD	C1	C2	H	K	N	Z	Kg
6682 17 21	16.5	G1/2	G1/4	89.5	84.5	82	63.5	0.660
6682 25 21	25	G1/2	G1/4	92.5	84.5	82	63.5	0.680

Supplied with G1/2" end caps

Ø  
25

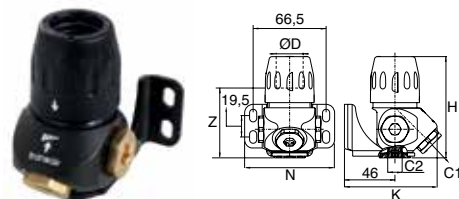

**3 PORT WALL BRACKET - BSP PARALLEL**

Transair®	ØD	C1	C2	H	K	N	Z	Kg
6695 25 21	25	G1/2	G1/4	92.5	84.5	82	63.5	0.725

Supplied with G1/2" end caps

# WALL BRACKETS

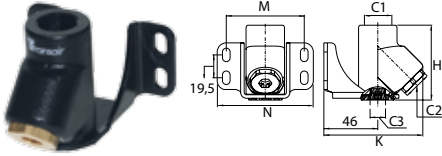

## 1 PORT 45° THREADED WALL BRACKET - BSP PARALLEL

Transair®	C1	C2	C3	H	K	M	N	Kg
6641 21 21	G1/2	G1/2	G1/4	64	84.5	66.5	82	0.539

Supplied with G1/2" end cap

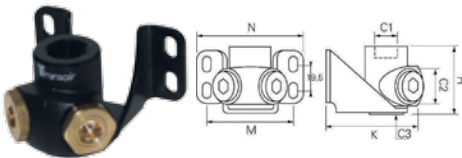

## 2 PORT 90° THREADED WALL BRACKET - BSP PARALLEL

Transair®	C1	C2	C3	H	K	M	N	Kg
6686 21 21	G1/2	G1/2	G1/4	48	72.5	66.5	82	0.415

Supplied with G1/2" end caps

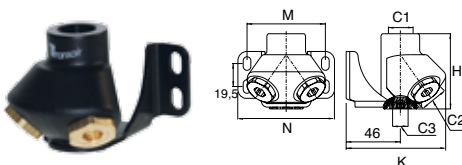

## 2 PORT 45° THREADED WALL BRACKET - BSP PARALLEL

Transair®	C1	C2	C3	H	K	M	N	Kg
6690 21 21	G1/2	G1/2	G1/4	64	84.5	66.5	82	0.672

Supplied with G1/2" end caps

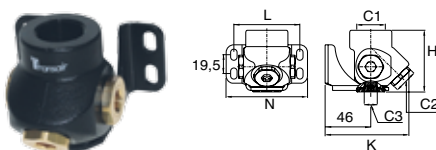

## 3 PORT THREADED WALL BRACKET - BSP PARALLEL

Transair®	C1	C2	C3	H	K	N	Z	Kg
6635 27 21	G3/4	G1/2	G1/4	64	66.5	82	84.5	0.750

Supplied with G1/2" end-caps

Ø  
16.5  
25



### 1 PORT 45° WALL BRACKET WITH COUPLER

Transair®	ØD	Profile	Bore (mm)	Kg
6677 17 A1	16.5	ARO	5.5	0.661
6677 17 E4	16.5	EURO	7.2	0.664
6677 17 U1	16.5	ISO B	5.5	0.615
6677 17 U2	16.5	ISO B	8	0.668
6677 25 A1	25	ARO	5.5	0.658
6677 25 E4	25	EURO	7.2	0.661
6677 25 U1	25	ISO B	5.5	0.640
6677 25 U2	25	ISO B	8	0.665

Ø  
16.5  
25



### 2 PORT 45° WALL BRACKET WITH COUPLERS

Transair®	ØD	Profile	Bore (mm)	Kg
6692 17 A1	16.5	ARO	5.5	0.890
6692 17 E4	16.5	EURO	7.2	0.880
6692 17 U1	16.5	ISO B	5.5	0.830
6692 17 U2	16.5	ISO B	8	0.809
6692 25 A1	25	ARO	5.5	0.950
6692 25 E4	25	EURO	7.2	0.950
6692 25 U1	25	ISO B	5.5	0.846
6692 25 U2	25	ISO B	8	0.957

1/2" BSP parallel connection between the wall bracket and the composite safety coupler.

Couplers supplied with 6671 wall bracket .

Ø  
16.5  
25



### 2 PORT 90° WALL BRACKET WITH COUPLERS

Transair®	ØD	Profile	Bore (mm)	Kg
6671 17 U1	16.5	ISO B	5.5	0.645
6671 17 U2	16.5	ISO B	8	0.682
6671 17 E4	16.5	EURO	7.2	0.698
6671 17 A1	16.5	ARO	5.5	0.700
6671 25 U1	25	ISO B	5.5	0.690
6671 25 U2	25	ISO B	8	0.755
6671 25 E4	25	EURO	7.2	0.745
6671 25 A1	25	ARO	5.5	0.735

1/2" BSP parallel connection between the wall bracket and the composite safety coupler.

Couplers supplied with 6671 wall bracket .

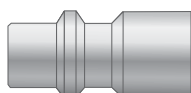

ISO B

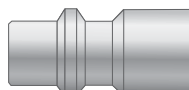

EURO 7,2

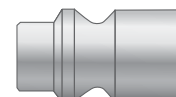

ARO 5,5



# TOOLS

Ø  
16.5  
↓  
63



## TOOL CASE

Transair®	H	L	I	Kg
6698 00 05	315	290	105	5.300

Content of tool case 6698 00 05:

- Drilling jig 6698 01 03
- Drilling tools 6698 02 01 and 6698 02 02
- Cutter for rigid pipe 6698 03 01
- Deburring tool 6698 04 02
- Set of tightening spanners 6698 05 03
- Marking tool 6698 04 03
- Chamfer tool 6698 04 01

Ø  
16.5  
↓  
168

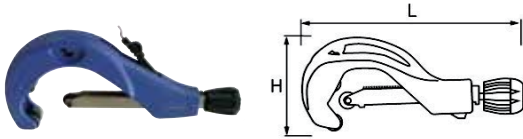

## TUBE CUTTER WITH DEBURRING TOOL

Transair®	L	H	Kg	For Transair® pipe
6698 03 01	230	98	0.886	Ø 16.5 - 25 - 40 - 50 - 63 - 76
EW08 00 03	600	300	2.000	Ø 100 - 168

Spare rotary blade for Transair® cutter 6698 03 01: EW08 00 99  
Spare rotary blade for Transair® cutter EW08 00 03: EW08 00 04

Ø  
25  
40  
50  
63

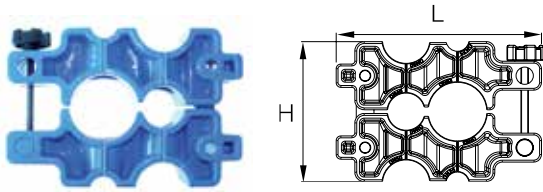

## DRILLING JIG FOR RIGID ALUMINIUM PIPE

Transair®	L	H	Kg	For Transair® pipe
6698 01 03	220	150	2.355	Ø 25 - 40 - 50 - 63

After drilling, it is necessary to deburr and clean the pipe.

Ø  
25  
40  
50  
63

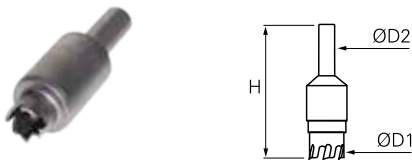

## DRILLING TOOL FOR RIGID ALUMINIUM PIPE

Transair®	ØD1	ØD2	H	Kg	For Transair® pipe
6698 02 02	16	13	77	0.143	Ø 25
6698 02 01	22	13	77	0.154	Ø 40 - 50 - 63

Drilling tool 6698 02 02 allows the installation of Ø25 Transair® brackets.  
Drilling tool 6698 02 01 allows the installation of Ø40, Ø50 or Ø63 Transair® brackets.  
It is also used to create the 2 holes needed for double-clamp ring connectors when cutting to length Ø. Both tools can be used with all types of drill, with the drilling tool 6698 01 03 at a maximum rotation speed of 650 tr/min.  
After drilling, it is necessary to deburr and clean the pipe.

Ø  
40  
↓  
168

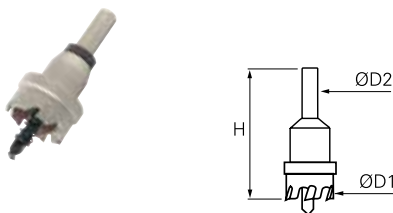

## DRILLING TOOL WITH CENTRING DRILL FOR ALUMINIUM PIPE

Transair®	ØD1	ØD2	H	Kg	For Transair® Pipe	Outlets
EW09 00 22	22	13	87	0.120	Ø 40 - 50 - 63	Ø25 - 1/2" - 3/4"
EW09 00 30	30	13	86	0.127	Ø 76 - 100	1"
EW09 00 51	51	13	83	0.325	Ø 76 - 100 - 168	1" 1/2 - 2"
EW09 00 64	64	13	85	0.407	Ø 168	2"
EW09 00 70	70	13	83	0.420	Ø 168	2" 1/2
EW09 00 90	90	13	86	0.600	Ø 168	3"

Thanks to its unique design, EW09 00 22 drilling tool may be used to carefully drill pipes without use of jig 6698 02 01.  
Both tools can be used on any type of drilling machine, without the drilling jig, at a maximum rotation speed of 450 tr/min for the aluminium pipes.  
After drilling, it is necessary to deburr and clean the pipe.

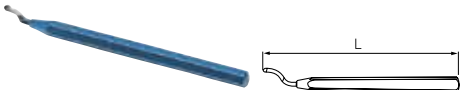
$\emptyset$ 16.5 ↓ 100		<b>DEBURRING TOOL FOR RIGID ALUMINIUM PIPE</b>		
		Transair®	L	Kg
		6698 04 02	140	0.026

$\emptyset$ 16.5 25 40		<b>CHAMFER TOOL FOR RIGID ALUMINIUM PIPE</b>		
		Transair®	H	Kg
		6698 04 01	64	0.104

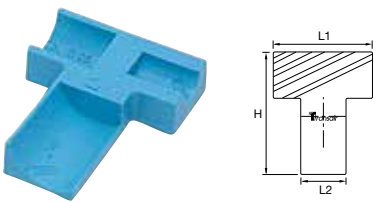
$\emptyset$ 16.5 25 40		<b>MARKING TOOL FOR RIGID ALUMINIUM PIPE</b>				
		Transair®	H	L1	L2	Kg
		6698 04 03	88	73	33	0.042

The marking tool enables connection guidelines to be marked on cut lengths of Transair® pipe. These marks indicate the insertion limits of the pipe into each fitting in order to ensure good airtight connection and security of grip.

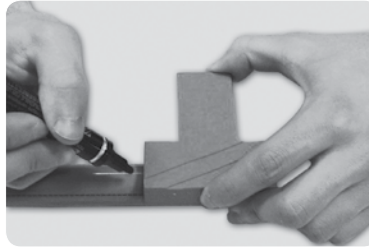

$\emptyset$ 50 63		<b>SET OF TIGHTENING SPANNERS FOR Ø50 AND Ø63</b>	
		Transair®	Kg
		6698 05 03	0,789

This set includes 2 tightening spanners.

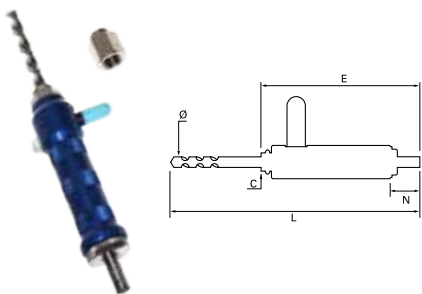
$\emptyset$ 25 40 50 63		<b>PRESSURISED SYSTEM DRILLING TOOL</b>						
		Transair®	C	ØD	E	L	N	Kg
		EA98 06 00	G1/2	13	154	330	30.5	0.820

Supplied with a spacer.

Ø  
76  
100  
168



## PORTABLE TOOL KIT

Transair®	V	Kg
EW01 00 01	220	9.240
EW01 00 03	110	9.240

This case contains: 1 portable tool, 1 14.4 V battery and 1 battery charger.

Ø  
76  
100  
168

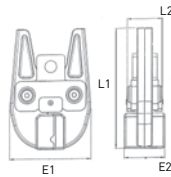

## JAW SET FOR PORTABLE TOOL

Transair®	ØD	E1	E2	L1	L2	Kg
EW02 L1 00	76	103	52	154	46	2.603
EW02 L3 00	100	103	71	154	46	2.868
EW02 L8 00	168	103	71	154	46	2.800

Ø  
76  
100  
168



## 14.4V BATTERY FOR PORTABLE TOOL

Transair®	Voltage	Type	Kg
EW03 00 01	14,4V	NiCd	0,690

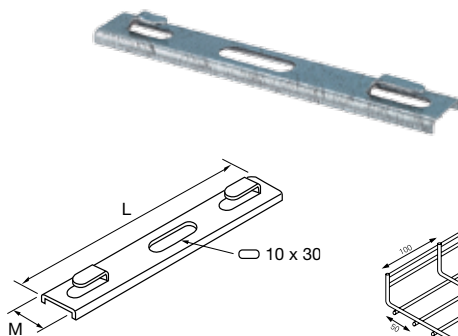

## FIXTURE FOR CABLE TRAY

Transair®	L	M	Kg
6699 10 03	140	22	0.036

Ø tray metal rod: from 4 to 6mm.

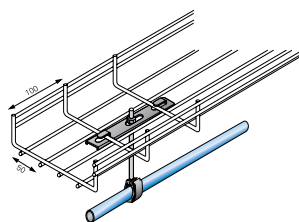

# I FIXTURES AND ACCESSORIES

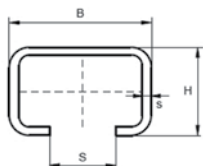
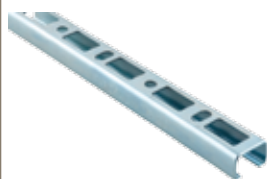

## U-CHANNEL

Transair®	L	H	B	Kg
6699 01 01	2000	30	30	1.584

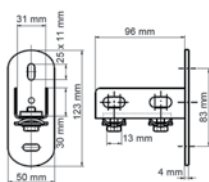

## U-CHANNEL FIXING BRACKET

Transair®	L	H	Kg
6699 01 02	50	123	0.176

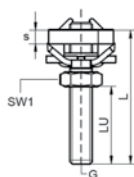

## U-CHANNEL HAMMERFIX NUT

Transair®	L	G	Clip ØD	Kg
6699 01 03	50	M10	50 - 63 - 76 - 100	0.050
6699 01 04	40	M8	16.5 - 25 - 40	0.020

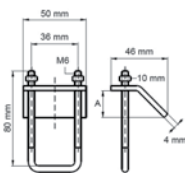

## U CHANNEL FIXTURE BRACKET FOR FIXING ON RSJ

Transair®	L	H	Kg
6699 03 02	50	80	0.080

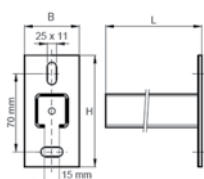
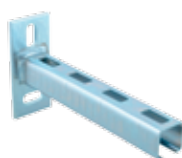

## CANTILEVER ARM

Transair®	B	H	L	Kg
6699 01 06	48	110	500	0.400

The use of this adaptor facilitates the suspension of Transair® from M10 threaded rod.

# FIXTURES AND ACCESSORIES

∅  
16.5  
↓  
100

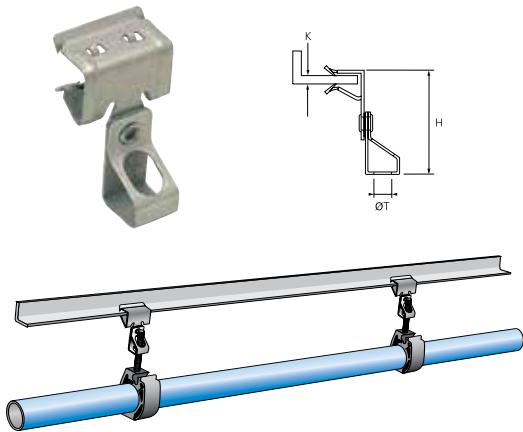

## PUSH-ON TYPE BEAM CLAMP

Transair®	H	K	ØT	Max. carrying load (kg)	Kg
6699 02 01	44	1.5 à 3	M8	68	0.022
6699 02 02	46	3 à 8	M8	68	0.029
6699 02 03	54	8 à 14	M8	68	0.030
6699 02 04	66	14 à 20	M8	68	0.031
6699 02 05	44	1.5 à 3	M10	68	0.020
6699 02 06	46	3 à 8	M10	68	0.031

∅  
16.5  
↓  
100

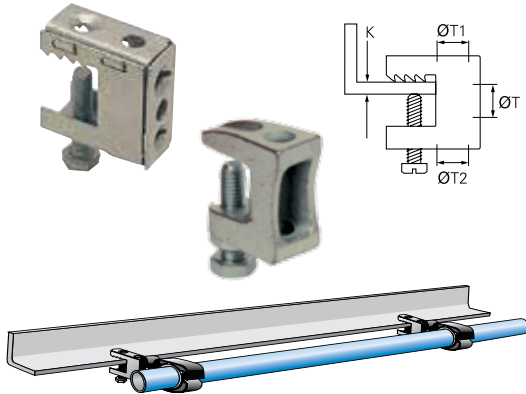

## SCREW TYPE BEAM CLAMP

Transair®	ØT2	ØT	ØT1	K	Max. carrying load (kg)	Kg
6699 03 01	10.7	6.5	10.7	18	45	0.030

Transair®	For screw	Kg
ER99 06 02	M8	0.080
ER99 06 03	M10	0.140

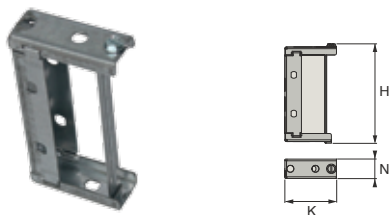

## FIXTURE FOR CANALIS

Transair®	Profile	H	K	N	Kg
6699 10 01	KN	118	61	23	0.102
6699 10 02	KS	181.5	151	30	0.120



## THREADED ROD KIT

Transair®	C	Kg
ER99 05 02	M8	3.550
ER99 05 03	M10	5.250

Contains 10 threaded rods 1 metre length, 50 nuts and 10 threaded connectors.

# I FRL, AUTOMATIC DRAINS AND ACCESSORIES

Transair® FRLs are ideal for general purpose use and can be fitted downstream of the compressed air installation and at the take-off point on workstations and machines.

- I Air quality at FRL inlet: dry, damp, lubricated
- I Transair® FRL products are guaranteed silicone free
- I Chemical resistance to compressor oils



## FILTER REGULATOR LUBRICATOR WITH GAUGE

Transair®	C	Recommended Flow	Bowl Capacity	Max. Inlet Pressure	Max. Outlet Pressure	T°C at 10 bar	Filtration	Kg
6708 00 13	G1/4	33 m³/h	22 cm³	16 bar	8 bar	0°C à +50°C	30 µm	0.779
6708 00 21	G1/2	114 m³/h	50 cm³	16 bar	8 bar	0°C à +50°C	30 µm	1.316

Semi-automatic condensate drainage



## FILTER REGULATOR

Transair®	C	Recommended Flow	Bowl Capacity	Max. Inlet Pressure	Max. Outlet Pressure	T°C at 10 bar	Filtration	Kg	Associated Gauge
6700 00 13	G1/4	33 m³/h	22 cm³	16 bar	8 bar	0°C à +50°C	30 µm	0,342	6798 00 05
6700 00 21	G1/2	114 m³/h	50 cm³	16 bar	8 bar	0°C à +50°C	30 µm	0,721	6798 00 06

Semi-automatic condensate drainage



## REGULATOR

Transair®	C	Recommended Flow	Max. Inlet Pressure	Max. Outlet Pressure	Temperature	Kg	Associated Gauge
6701 00 13	G1/4	33 m³/h	16 bar	8 bar	0°C à +60°C	0,315	6798 00 05
6701 00 21	G1/2	114 m³/h	16 bar	8 bar	0°C à +60°C	0,420	6798 00 06

# FRL, AUTOMATIC DRAIN AND ACCESSORIES

All these products can be easily connected to Transair®, compressed air pipework systems using the following Transair® stud fittings:

I 6605 17 13 or 6609 17 13 for G1/4" port

I 6605 17 21 or 6609 / 6619 25 21 for G1/2" port



## FILTER SEPARATOR

Transair®	C	Recommended Flow	Bowl Capacity	Max. Inlet Pressure	Max. Outlet Pressure	T°C at 10 bar	Filtration	Kg
6702 00 13	G1/4	33m³/h	22cm³	16 bar	8 bar	0°C à +50°C	30 µm	0.275
6702 00 21	G1/2	114m³/h	50cm³	16 bar	8 bar	0°C à +50°C	30 µm	0.510

Semi-automatic condensate drainage



## LUBRICATOR

Transair®	C	Max. Inlet Pressure	Max. Outlet Pressure	T°C at 10 bar	Oil Capacity	Kg
6703 00 13	G1/4	16 bar	8 bar	0°C à +50°C	45cm³	0.287
6703 00 21	G1/2	16 bar	8 bar	0°C à +50°C	112cm³	0.531

Oil mist lubricator  
Semi-automatic condensate drainage



### AUTOMATIC DRAIN

Transair®	C	Kg
6706 00 21	G1/2	0.340

Automatic condensate drain with float.



### PRESSURE GAUGE

Transair®	C	Ø Face mm	Kg	Associated FRL
6798 00 05	G1/8	40	0.077	6700 00 13 - 6701 00 13
6798 00 06	G1/4	50	0.098	6700 00 21 - 6701 00 21

To be mounted on the front face of filter regulator 6700 and regulator 6701.



### PROTECTION BOWL

Transair®	C	Kg
6798 00 07	G1/4	0.070
6798 00 08	G1/2	0.180

To be used with filter regulator, filter separator and filter regulator lubricator set. Equipped with snap mounting.



### MOUNTING BRACKETS

Transair®	C	Kg
6798 00 01	G1/4	0.141
6798 00 02	G1/2	0.133

For wall or machine fixing  
Screws supplied  
Wall fixing-to-centre: 46mm [compatible with Transair® fixing clips 6697]



### ASSEMBLY KIT

Transair®	C	Kg
6798 00 03	G1/4	0.019
6798 00 04	G1/2	0.029

To join separate FRL units.



# HOSE REELS – BLOWGUN - RECOIL TUBING

## Hose reels

- Optimise productivity and the safety of your work area
- Prevent hose damage occurring on the workshop floor

## Polyurethane Recoil Tubing

- Perfectly suited to installations requiring flexibility in a reduced space
- Fluid: compressed air
- Max. working pressure at 20°C: 10 bar

Working temperature: -15°C to +70°C

## Blowgun

- Dusting, cooling and drying components
- Removing swarf, Cleaning machinery
- Max. working pressure: 10 bar
- Working temperature: -15°C to +50°C
- OSHA certified

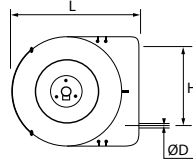

## HOSE REEL ENCLOSED CASE

Transair®	ØD	Hose Length (m)	Hose i.d. (mm)	Max. Pressure (bar)	H	L	Kg
6698 10 01	6	10	8	15	170	350	3.400
6698 10 02	10.5	16	8	15	251	470	6.440

Hose clutch with free return  
Hose length upstream: 1,50m  
Input connection: bare pipe - Output connection: 1/4" male

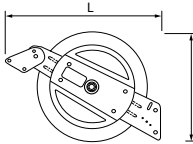

## HOSE REEL OPEN CASE

Transair®	Hose Length (m)	Hose i.d. (mm)	Max. Pressure (bar)	H	L	Kg
6698 11 01	20	10	20	425	480	11.740

Hose clutch with free return  
Input connection: 1/2" female - Output connection: 3/8" male

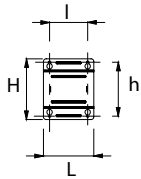

## PIVOTING BRACKET

Transair®	Used with Hose Reel	h	H	I	L	Kg
6698 11 98	6698 11 01	196	225	140	185	2.491

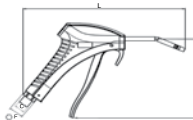

## BLOWGUN

Transair®	C	Ø	H	L	Kg
EA59 00 13	G1/4	3.5	120	223	0.107

## PU RECOIL TUBING - EXTENDED LENGTH 2 M, 4 M, 6 M

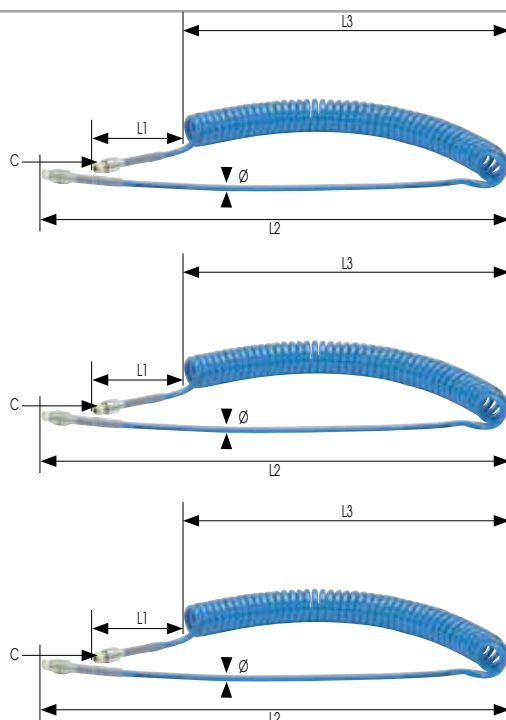

Transair®	Øout.	Øin.	C	L1	L2	L3	Ø	Kg
1470U06 04 13TR	6	4	R1/4	100	300	630	32	0.178
1470U08 04 13TR	8	5	R1/4	100	500	780	42	0.235
1470U10 04 13TR	10	7	R1/4	100	500	780	62	0.448
1470U12 04 17TR	12	8	R3/8	100	500	780	65	0.502

Transair®	Øout.	Øin.	C	L1	L2	L3	Ø	Kg
1471U06 04 13TR	6	4	R1/4	100	300	850	32	0.243
1471U08 04 13TR	8	5	R1/4	100	500	1000	42	0.343
1471U10 04 13TR	10	7	R1/4	100	500	1000	62	0.660
1471U12 04 17TR	12	8	R3/8	100	500	990	65	0.737

Transair®	Øout.	Øin.	C	L1	L2	L3	Ø	Kg
1472U08 04 13TR	8	5	R1/4	100	500	1230	42	0.460
1472U10 04 13TR	10	7	R1/4	100	500	1140	62	0.828
1472U12 04 17TR	12	8	R3/8	100	500	1190	65	0.900

# HOSES AND TAILPIECE ADAPTORS

## Braided PVC Hose

- | Resistant and suitable for direct supply to machinery and hose reels, etc.
- | Fluid: compressed air
- | Max. working pressure at 23°C: 20 bar
- | Working temperature: from -15°C to +60°C

25 m



### BRAIDED BLUE PVC HOSE 25M

Transair®	Øout.	Øin.	Bend Radius	Kg
1025V12 04 06TR	12	6	50	3.080
1025V14 04 08TR	14	8	65	3.280
1025V16 04 10TR	16	10	75	4.040
1025V20 04 13TR	20	13	90	5.360
1025V24 04 16TR	24	16	125	8.820
1025V28 04 20TR	28	20	170	8.950
1025V34 04 25TR	34	25	219	12.425
1025V41 04 32TR	41	32	350	15.725
1025V50 04 40TR	50	40	420	21.625

### CLIP FOR BRAIDED PVC HOSE

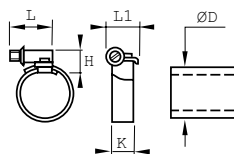

Transair®	ØD	H	K	L	L1	Kg
0697 00 02TR	12-14	12	9	21	13	0.012
0697 00 03TR	16	12	9	24	13	0.014
0697 00 04TR	20	12	9	24	13	0.015
0697 00 05TR	24	12	9	24	13	0.016
0697 00 06TR	28	12	9	24	13	0.016
0697 00 07TR	34	12	9	26	13	0.018
0697 00 08TR	41	12	9	26	13	0.019
0697 00 09TR	50	12	9	26	13	0.021

### TAILPIECE ADAPTOR FOR PVC HOSE MALE BSPP

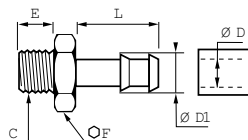

Transair®	ØD	ØDI	C	E	F	L	Kg
EF26 06 01	6	7	G1/8	6	12	20	0.009
EF26 06 02	6	7	G1/4	8	17	21	0.013
EF26 08 02	8	9	G1/4	8	17	21	0.014
EF26 08 03	8	9	G3/8	9	19	21	0.023
EF26 10 02	10	12	G1/4	8	14	20	0.016
EF26 10 03	10	12	G3/8	9	19	20	0.024
EF26 10 04	10	12	G1/2	10	22	20	0.032
EF26 13 02	13	15	G1/4	8	17	21	0.029
EF26 13 03	13	15	G3/8	9	19	22	0.027
EF26 13 04	13	15	G1/2	10	24	25	0.041
EF26 16 03	16	18	G3/8	9	19	21	0.037
EF26 16 04	16	18	G1/2	10	24	25	0.043
EF26 20 06	20	20	G3/4	13	22	37	0.087
EF26 25 08	25	25	G1"	15	28	37	0.130
EF26 32 10	32	32	G1"1/4	17	37	46	0.211
EF26 40 12	40	40	G1"1/2	17	43	46	0.262

Supplied with captive sealing washer.  
Ideally suited for use with Transair® PVC hose.

# COMPOSITE AUTOMATIC SAFETY COUPLERS

- ▮ To securely connect and disconnect devices and tools from Transair® quick assembly brackets or wall brackets
- ▮ Very high flow, extremely low pressure loss
- ▮ Lightweight and robust
- ▮ Improved hand grip
- ▮ Fast vent time
- ▮ Male thread with integral seal

For heavy duty or dusty applications, we recommend the use of the automatic metal couplers (pages 60/61).

ISO B 5.5 mm		<b>MALE BODY, BSP PARALLEL</b>		<b>FEMALE BODY, BSP PARALLEL</b>		<b>BODY WITH HOSETAIL</b>																				
		<table border="1"> <thead> <tr> <th>Transair®</th> <th>C</th> </tr> </thead> <tbody> <tr> <td>CP01 U1 02</td> <td>G1/4</td> </tr> <tr> <td>CP01 U1 03</td> <td>G3/8</td> </tr> <tr> <td>CP01 U1 04</td> <td>G1/2</td> </tr> </tbody> </table>		Transair®		C	CP01 U1 02	G1/4	CP01 U1 03	G3/8	CP01 U1 04	G1/2	<table border="1"> <thead> <tr> <th>Transair®</th> <th>C</th> </tr> </thead> <tbody> <tr> <td>CP14 U1 02</td> <td>G1/4</td> </tr> <tr> <td>CP14 U1 03</td> <td>G3/8</td> </tr> <tr> <td>CP14 U1 04</td> <td>G1/2</td> </tr> </tbody> </table>	Transair®	C	CP14 U1 02	G1/4	CP14 U1 03	G3/8	CP14 U1 04	G1/2	<table border="1"> <thead> <tr> <th>Transair®</th> <th>ØD</th> </tr> </thead> <tbody> <tr> <td>CP21 U1 06</td> <td>6</td> </tr> <tr> <td>CP21 U1 08</td> <td>8</td> </tr> <tr> <td>CP21 U1 10</td> <td>10</td> </tr> </tbody> </table>	Transair®	ØD	CP21 U1 06	6
Transair®	C																									
CP01 U1 02	G1/4																									
CP01 U1 03	G3/8																									
CP01 U1 04	G1/2																									
Transair®	C																									
CP14 U1 02	G1/4																									
CP14 U1 03	G3/8																									
CP14 U1 04	G1/2																									
Transair®	ØD																									
CP21 U1 06	6																									
CP21 U1 08	8																									
CP21 U1 10	10																									
SAFETY																										
ISO B 8 mm		<b>MALE BODY, BSP PARALLEL</b>		<b>FEMALE BODY, BSP PARALLEL</b>		<b>BODY WITH HOSETAIL</b>																				
		<table border="1"> <thead> <tr> <th>Transair®</th> <th>C</th> </tr> </thead> <tbody> <tr> <td>CP01 U2 02</td> <td>G1/4</td> </tr> <tr> <td>CP01 U2 03</td> <td>G3/8</td> </tr> <tr> <td>CP01 U2 04</td> <td>G1/2</td> </tr> </tbody> </table>		Transair®		C	CP01 U2 02	G1/4	CP01 U2 03	G3/8	CP01 U2 04	G1/2	<table border="1"> <thead> <tr> <th>Transair®</th> <th>C</th> </tr> </thead> <tbody> <tr> <td>CP14 U2 02</td> <td>G1/4</td> </tr> <tr> <td>CP14 U2 03</td> <td>G3/8</td> </tr> <tr> <td>CP14 U2 04</td> <td>G1/2</td> </tr> </tbody> </table>	Transair®	C	CP14 U2 02	G1/4	CP14 U2 03	G3/8	CP14 U2 04	G1/2	<table border="1"> <thead> <tr> <th>Transair®</th> <th>ØD</th> </tr> </thead> <tbody> <tr> <td>CP21 U2 08</td> <td>8</td> </tr> <tr> <td>CP21 U2 10</td> <td>10</td> </tr> <tr> <td>CP21 U2 13</td> <td>13</td> </tr> </tbody> </table>	Transair®	ØD	CP21 U2 08	8
Transair®	C																									
CP01 U2 02	G1/4																									
CP01 U2 03	G3/8																									
CP01 U2 04	G1/2																									
Transair®	C																									
CP14 U2 02	G1/4																									
CP14 U2 03	G3/8																									
CP14 U2 04	G1/2																									
Transair®	ØD																									
CP21 U2 08	8																									
CP21 U2 10	10																									
CP21 U2 13	13																									
SAFETY																										
EURO 7.2 mm		<b>MALE BODY, BSP PARALLEL</b>		<b>FEMALE BODY, BSP PARALLEL</b>		<b>BODY WITH HOSETAIL</b>																				
		<table border="1"> <thead> <tr> <th>Transair®</th> <th>C</th> </tr> </thead> <tbody> <tr> <td>CP01 E4 02</td> <td>G1/4</td> </tr> <tr> <td>CP01 E4 03</td> <td>G3/8</td> </tr> <tr> <td>CP01 E4 04</td> <td>G1/2</td> </tr> </tbody> </table>		Transair®		C	CP01 E4 02	G1/4	CP01 E4 03	G3/8	CP01 E4 04	G1/2	<table border="1"> <thead> <tr> <th>Transair®</th> <th>C</th> </tr> </thead> <tbody> <tr> <td>CP14 E4 02</td> <td>G1/4</td> </tr> <tr> <td>CP14 E4 03</td> <td>G3/8</td> </tr> <tr> <td>CP14 E4 04</td> <td>G1/2</td> </tr> </tbody> </table>	Transair®	C	CP14 E4 02	G1/4	CP14 E4 03	G3/8	CP14 E4 04	G1/2	<table border="1"> <thead> <tr> <th>Transair®</th> <th>ØD</th> </tr> </thead> <tbody> <tr> <td>CP21 E4 08</td> <td>8</td> </tr> <tr> <td>CP21 E4 10</td> <td>10</td> </tr> <tr> <td>CP21 E4 13</td> <td>13</td> </tr> </tbody> </table>	Transair®	ØD	CP21 E4 08	8
Transair®	C																									
CP01 E4 02	G1/4																									
CP01 E4 03	G3/8																									
CP01 E4 04	G1/2																									
Transair®	C																									
CP14 E4 02	G1/4																									
CP14 E4 03	G3/8																									
CP14 E4 04	G1/2																									
Transair®	ØD																									
CP21 E4 08	8																									
CP21 E4 10	10																									
CP21 E4 13	13																									
SAFETY																										
ARO 5.5 mm		<b>MALE BODY, BSP PARALLEL</b>		<b>FEMALE BODY, BSP PARALLEL</b>		<b>BODY WITH HOSETAIL</b>																				
		<table border="1"> <thead> <tr> <th>Transair®</th> <th>C</th> </tr> </thead> <tbody> <tr> <td>CP01 A1 02</td> <td>G1/4</td> </tr> <tr> <td>CP01 A1 03</td> <td>G3/8</td> </tr> <tr> <td>CP01 A1 04</td> <td>G1/2</td> </tr> </tbody> </table>		Transair®		C	CP01 A1 02	G1/4	CP01 A1 03	G3/8	CP01 A1 04	G1/2	<table border="1"> <thead> <tr> <th>Transair®</th> <th>C</th> </tr> </thead> <tbody> <tr> <td>CP14 A1 02</td> <td>G1/4</td> </tr> <tr> <td>CP14 A1 03</td> <td>G3/8</td> </tr> <tr> <td>CP14 A1 04</td> <td>G1/2</td> </tr> </tbody> </table>	Transair®	C	CP14 A1 02	G1/4	CP14 A1 03	G3/8	CP14 A1 04	G1/2	<table border="1"> <thead> <tr> <th>Transair®</th> <th>ØD</th> </tr> </thead> <tbody> <tr> <td>CP21 A1 06</td> <td>6</td> </tr> <tr> <td>CP21 A1 08</td> <td>8</td> </tr> <tr> <td>CP21 A1 10</td> <td>10</td> </tr> </tbody> </table>	Transair®	ØD	CP21 A1 06	6
Transair®	C																									
CP01 A1 02	G1/4																									
CP01 A1 03	G3/8																									
CP01 A1 04	G1/2																									
Transair®	C																									
CP14 A1 02	G1/4																									
CP14 A1 03	G3/8																									
CP14 A1 04	G1/2																									
Transair®	ØD																									
CP21 A1 06	6																									
CP21 A1 08	8																									
CP21 A1 10	10																									
SAFETY																										



SAFETY

ISO B 5,5 mm

ISO 6150 B  
AFNOR NF 49-053  
US.MIL.C4109  
CEJN 310  
RECTUS 23-24

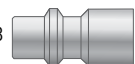

ISO B 8 mm

ISO 6150 B  
AFNOR NF 49-053  
US.MIL.C4109  
CEJN 430  
RECTUS 30

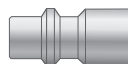

EURO 7,2 mm

CEJN 320  
RECTUS 25-26



ARO 5,5 mm

ARO 210  
CEJN 300  
ORION 44510  
PARKER 50  
RECTUS 14-22

## FLOW CURVES - PRESSURE LOSS

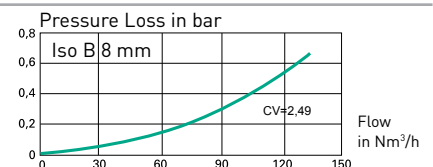
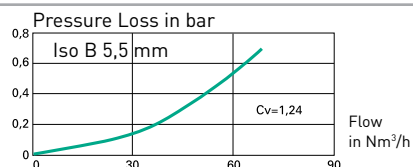

Transair® composite automatic couplers disconnect by a double twist of the sleeve – a safety feature that breaks deliberately with common practice in order to avoid accidental disconnection.

100% safety - ISO 4414

1st rotation in direction of the arrow : circuit rapidly flushed out, probe side.



2nd rotation in direction of the arrow : safe disconnection of body and probe.

ISO B 5.5 mm	MALE PROBE, BSP PARALLEL	FEMALE PROBE, BSP PARALLEL	PROBE WITH HOSETAIL																								
	<table border="1"> <thead> <tr> <th>Transair®</th> <th>C</th> </tr> </thead> <tbody> <tr> <td>CA87 U1 02</td> <td>G1/4</td> </tr> <tr> <td>CA87 U1 03</td> <td>G3/8</td> </tr> <tr> <td>CA87 U1 04</td> <td>G1/2</td> </tr> </tbody> </table>	Transair®	C	CA87 U1 02	G1/4	CA87 U1 03	G3/8	CA87 U1 04	G1/2	<table border="1"> <thead> <tr> <th>Transair®</th> <th>C</th> </tr> </thead> <tbody> <tr> <td>CA86 U1 02</td> <td>G1/4</td> </tr> <tr> <td>CA86 U1 03</td> <td>G3/8</td> </tr> <tr> <td>CA86 U1 04</td> <td>G1/2</td> </tr> </tbody> </table>	Transair®	C	CA86 U1 02	G1/4	CA86 U1 03	G3/8	CA86 U1 04	G1/2	<table border="1"> <thead> <tr> <th>Transair®</th> <th>ØD</th> </tr> </thead> <tbody> <tr> <td>CA94 U1 06</td> <td>6</td> </tr> <tr> <td>CA94 U1 08</td> <td>8</td> </tr> <tr> <td>CA94 U1 10</td> <td>10</td> </tr> </tbody> </table>	Transair®	ØD	CA94 U1 06	6	CA94 U1 08	8	CA94 U1 10	10
Transair®	C																										
CA87 U1 02	G1/4																										
CA87 U1 03	G3/8																										
CA87 U1 04	G1/2																										
Transair®	C																										
CA86 U1 02	G1/4																										
CA86 U1 03	G3/8																										
CA86 U1 04	G1/2																										
Transair®	ØD																										
CA94 U1 06	6																										
CA94 U1 08	8																										
CA94 U1 10	10																										
	<table border="1"> <thead> <tr> <th>Transair®</th> <th>C</th> </tr> </thead> <tbody> <tr> <td>CA87 U2 02</td> <td>G1/4</td> </tr> <tr> <td>CA87 U2 03</td> <td>G3/8</td> </tr> <tr> <td>CA87 U2 04</td> <td>G1/2</td> </tr> </tbody> </table>	Transair®	C	CA87 U2 02	G1/4	CA87 U2 03	G3/8	CA87 U2 04	G1/2	<table border="1"> <thead> <tr> <th>Transair®</th> <th>C</th> </tr> </thead> <tbody> <tr> <td>CA86 U2 02</td> <td>G1/4</td> </tr> <tr> <td>CA86 U2 03</td> <td>G3/8</td> </tr> <tr> <td>CA86 U2 04</td> <td>G1/2</td> </tr> </tbody> </table>	Transair®	C	CA86 U2 02	G1/4	CA86 U2 03	G3/8	CA86 U2 04	G1/2	<table border="1"> <thead> <tr> <th>Transair®</th> <th>ØD</th> </tr> </thead> <tbody> <tr> <td>CA94 U2 08</td> <td>8</td> </tr> <tr> <td>CA94 U2 10</td> <td>10</td> </tr> <tr> <td>CA94 U2 13</td> <td>13</td> </tr> </tbody> </table>	Transair®	ØD	CA94 U2 08	8	CA94 U2 10	10	CA94 U2 13	13
Transair®	C																										
CA87 U2 02	G1/4																										
CA87 U2 03	G3/8																										
CA87 U2 04	G1/2																										
Transair®	C																										
CA86 U2 02	G1/4																										
CA86 U2 03	G3/8																										
CA86 U2 04	G1/2																										
Transair®	ØD																										
CA94 U2 08	8																										
CA94 U2 10	10																										
CA94 U2 13	13																										
	<table border="1"> <thead> <tr> <th>Transair®</th> <th>C</th> </tr> </thead> <tbody> <tr> <td>CA87 E4 02</td> <td>G1/4</td> </tr> <tr> <td>CA87 E4 03</td> <td>G3/8</td> </tr> <tr> <td>CA87 E4 04</td> <td>G1/2</td> </tr> </tbody> </table>	Transair®	C	CA87 E4 02	G1/4	CA87 E4 03	G3/8	CA87 E4 04	G1/2	<table border="1"> <thead> <tr> <th>Transair®</th> <th>C</th> </tr> </thead> <tbody> <tr> <td>CA86 E4 02</td> <td>G1/4</td> </tr> <tr> <td>CA86 E4 03</td> <td>G3/8</td> </tr> <tr> <td>CA86 E4 04</td> <td>G1/2</td> </tr> </tbody> </table>	Transair®	C	CA86 E4 02	G1/4	CA86 E4 03	G3/8	CA86 E4 04	G1/2	<table border="1"> <thead> <tr> <th>Transair®</th> <th>ØD</th> </tr> </thead> <tbody> <tr> <td>CA94 E4 08</td> <td>8</td> </tr> <tr> <td>CA94 E4 10</td> <td>10</td> </tr> <tr> <td>CA94 E4 13</td> <td>13</td> </tr> </tbody> </table>	Transair®	ØD	CA94 E4 08	8	CA94 E4 10	10	CA94 E4 13	13
Transair®	C																										
CA87 E4 02	G1/4																										
CA87 E4 03	G3/8																										
CA87 E4 04	G1/2																										
Transair®	C																										
CA86 E4 02	G1/4																										
CA86 E4 03	G3/8																										
CA86 E4 04	G1/2																										
Transair®	ØD																										
CA94 E4 08	8																										
CA94 E4 10	10																										
CA94 E4 13	13																										
	<table border="1"> <thead> <tr> <th>Transair®</th> <th>C</th> </tr> </thead> <tbody> <tr> <td>CA87 A1 02</td> <td>G1/4</td> </tr> <tr> <td>CA87 A1 03</td> <td>G3/8</td> </tr> <tr> <td>CA87 A1 04</td> <td>G1/2</td> </tr> </tbody> </table>	Transair®	C	CA87 A1 02	G1/4	CA87 A1 03	G3/8	CA87 A1 04	G1/2	<table border="1"> <thead> <tr> <th>Transair®</th> <th>C</th> </tr> </thead> <tbody> <tr> <td>CA86 A1 02</td> <td>G1/4</td> </tr> <tr> <td>CA86 A1 03</td> <td>G3/8</td> </tr> <tr> <td>CA86 A1 04</td> <td>G1/2</td> </tr> </tbody> </table>	Transair®	C	CA86 A1 02	G1/4	CA86 A1 03	G3/8	CA86 A1 04	G1/2	<table border="1"> <thead> <tr> <th>Transair®</th> <th>ØD</th> </tr> </thead> <tbody> <tr> <td>CA94 A1 06</td> <td>6</td> </tr> <tr> <td>CA94 A1 08</td> <td>8</td> </tr> <tr> <td>CA94 A1 10</td> <td>10</td> </tr> </tbody> </table>	Transair®	ØD	CA94 A1 06	6	CA94 A1 08	8	CA94 A1 10	10
Transair®	C																										
CA87 A1 02	G1/4																										
CA87 A1 03	G3/8																										
CA87 A1 04	G1/2																										
Transair®	C																										
CA86 A1 02	G1/4																										
CA86 A1 03	G3/8																										
CA86 A1 04	G1/2																										
Transair®	ØD																										
CA94 A1 06	6																										
CA94 A1 08	8																										
CA94 A1 10	10																										

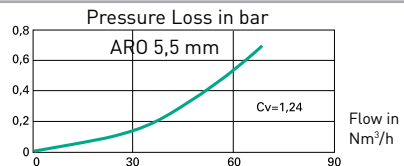
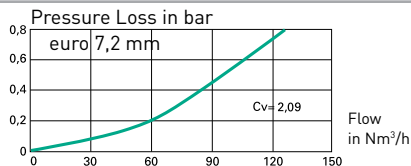

# METAL AUTOMATIC SAFETY COUPLERS

- | Safety: disconnection in 2 stages
- | Suitable Fluids:
  - models ISO B 6 and 8mm: compressed air, vacuum, inert gas
  - models ISO C 6, 8 and 11mm: compressed air, vacuum, inert gas

- | Max. working pressure:
  - models ISO B 6 and 8 mm: 16 bar
  - mode ISO C 6, 8 and 11 mm: 12, 10 and 8 bar

**ISO B  
6  
8  
mm**

**MALE BODY,  
BSP TAPER**

Transair®	C	DN
9D05 09 13P4	R1/4	5.5
9D05 09 17P4	R3/8	5.5
9D05 09 21P4	R1/2	5.5
9D05 10 13P4	R1/4	8
9D05 10 17P4	R3/8	8
9D05 10 21P4	R1/2	8



**SAFETY**

**FEMALE BODY,  
BSP PARALLEL**

Transair®	C	DN
9D14 09 13P4	G1/4	5.5
9D14 09 17P4	G3/8	5.5
9D14 09 21P4	G1/2	5.5
9D14 10 13P4	G1/4	8
9D14 10 17P4	G3/8	8
9D14 10 21P4	G1/2	8



**BODY WITH HOSETAIL**

Transair®	ØD	DN
9D21 09 06P4	6	5.5
9D21 09 08P4	8	5.5
9D21 09 10P4	10	5.5
9D21 10 08P4	8	8
9D21 10 10P4	10	8



**ISO C  
6  
8  
11  
mm**

**MALE BODY,  
BSP PARALLEL**

Transair®	C	DN
9D01 01 13P483	G1/4	5.5
9D01 01 17P483	G3/8	5.5
9D01 01 21P483	G1/2	5.5
9D01 02 13P483	G1/4	8
9D01 02 17P483	G3/8	8
9D01 02 21P483	G1/2	8



**SAFETY**

**FEMALE BODY,  
BSP PARALLEL**

Transair®	C	DN
9D14 01 13P483	G1/4	5.5
9D14 01 17P483	G3/8	5.5
9D14 01 21P483	G1/2	5.5
9D14 02 13P483	G1/4	8
9D14 02 17P483	G3/8	8
9D14 02 21P483	G1/2	8
9D14 03 17P483	G3/8	11
9D14 03 21P483	G1/2	11



**BODY WITH HOSETAIL**

Transair®	ØD	DN
9D21 01 06P483	6	5.5
9D21 01 08P483	8	5.5
9D21 01 09P483	9	5.5
9D21 01 13P483	13	5.5
9D21 02 10P483	10	8
9D21 02 13P483	13	8
9D21 03 13P483	13	11
9D21 03 16P483	16	11

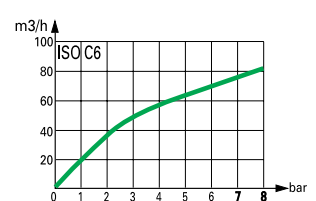
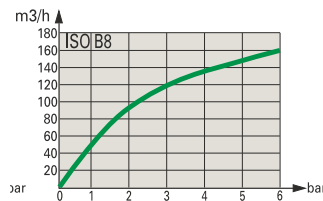
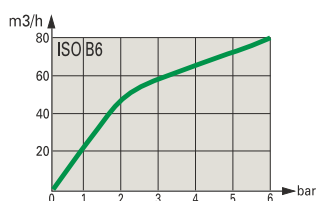
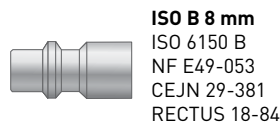
▮ Vacuum:

- models ISO B 6 and 8mm:  
99% (10 mbar absolute pressure)
- models ISO C 6, 8 and 11mm:  
99% (10 mbar absolute pressure)

▮ Working Temperature:

- models ISO B 6 and 8mm safety version:  
from -20°C to +90°C
- models ISO C 6, 8 and 11mm safety version:  
from -20°C to +60°C

**ISO B  
5.5 mm**



**MALE PROBE,  
BSP PARALLEL**

Transair®	C
CA87 U1 02	G1/4
CA87 U1 03	G3/8
CA87 U1 04	G1/2



**FEMALE PROBE,  
BSP PARALLEL**

Transair®	C
CA86 U1 02	G1/4
CA86 U1 03	G3/8
CA86 U1 04	G1/2



**PROBE WITH  
HOSETAIL**

Transair®	ØD
CA94 U1 06	6
CA94 U1 08	8
CA94 U1 10	10

**ISO B  
8 mm**



**MALE PROBE,  
BSP PARALLEL**

Transair®	C
CA87 U2 02	G1/4
CA87 U2 03	G3/8
CA87 U2 04	G1/2



**FEMALE PROBE,  
BSP PARALLEL**

Transair®	C
CA86 U2 02	G1/4
CA86 U2 03	G3/8
CA86 U2 04	G1/2



**PROBE WITH  
HOSETAIL**

Transair®	ØD
CA94 U2 08	8
CA94 U2 10	10
CA94 U2 13	13

**ISO C  
6  
8  
11  
mm**

**MALE PROBE,  
BSP PARALLEL**

Transair®	C	DN
9A87 01 10X099	G1/8	5.5
9A87 01 13X099	G1/4	5.5
9A87 01 17X099	G3/8	5.5
9A87 02 13X099	G1/4	8
9A87 02 17X099	G3/8	8
9A87 02 21X099	G1/2	8
9A87 03 17X099	G3/8	11
9A87 03 21X099	G1/2	11



**FEMALE PROBE,  
BSP PARALLEL**

Transair®	C	DN
9A86 01 10X099	G1/8	5.5
9A86 01 13X099	G1/4	5.5
9A86 01 70X099	M14 x1.25	5.5
9A86 02 13X099	G1/4	8
9A86 02 17X099	G3/8	8
9A86 02 21X099	G1/2	8
9A86 03 17X099	G3/8	11
9A86 03 21X099	G1/2	11



**PROBE WITH HOSETAIL**

Transair®	ØD	DN
9A94 01 06X099	6	5.5
9A94 01 08X099	8	5.5
9A94 01 10X099	10	5.5
9A94 01 13X099	13	5.5
9A94 02 06X099	6	8
9A94 02 08X099	8	8
9A94 02 10X099	10	8
9A94 02 13X099	13	8
9A94 03 08X099	8	11
9A94 03 13X099	13	11
9A94 03 16X099	16	11

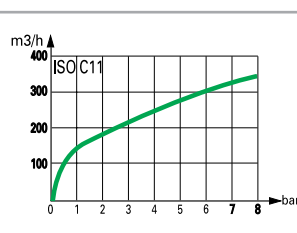
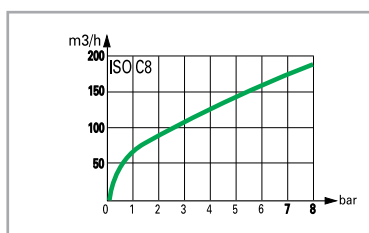
# CONNECTION ACCESSORIES

- I Nickel-plated brass
- I BSP parallel and taper

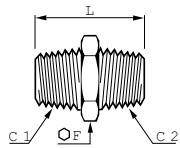

## STRAIGHT MALE BSP TAPER, EQUAL/UNEQUAL ADAPTOR

Transair®+	C1	C2	F	L	Kg
EF00 00 02	R1/4	R1/4	14	27	0.018
EF00 02 03	R1/4	R3/8	17	27.5	0.026
EF00 02 04	R1/4	R1/2	22	30.5	0.046
EF00 03 04	R3/8	R1/2	22	31	0.046
EF00 00 04	R1/2	R1/2	22	33.5	0.045
EF00 04 06	R1/2	R3/4	27	37.5	0.084
EF00 00 06	R3/4	R3/4	27	40	0.090
EF00 06 08	R3/4	R1"	34	43	0.143
EF00 00 08	R1"	R1"	34	45.5	0.153

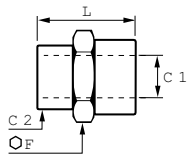

## STRAIGHT FEMALE BSP PARALLEL, EQUAL/UNEQUAL ADAPTOR

Transair®	C1	C2	F	L	Kg
EF02 00 02	G1/4	G1/4	17	22	0.020
EF02 02 03	G1/4	G3/8	22	23	0.031
EF02 00 03	G3/8	G3/8	22	24	0.034
EF02 02 04	G1/4	G1/2	27	27	0.032
EF02 03 04	G3/8	G1/2	27	27.5	0.036
EF02 00 04	G1/2	G1/2	27	30	0.050
EF02 04 06	G1/2	G3/4	30	30	0.077
EF02 00 06	G3/4	G3/4	30	32	0.079

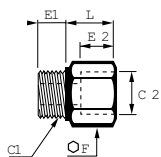

**INCREASER MALE BSP TAPER TO FEMALE BSP PARALLEL**

Transair®	C1	C2	E1	E2	F	L	Kg
EF06 02 03	R1/4	G3/8	8	11.5	22	14.5	0.031
EF06 02 04	R1/4	G1/2	8	15	27	18	0.036
EF06 03 04	R3/8	G1/2	9	15	27	18	0.053
EF06 04 06	R1/2	G3/4	11.5	10.5	29	24	0.043
EF06 04 08	R1/2	G1"	11.5	12	36	26.5	0.069
EF06 06 08	R3/4	G1"	13	12.5	36	28	0.074
EF06 08 10	R1"	G1"1/4	15	14	45	32	0.120

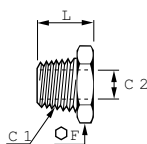

**REDUCER MALE BSP TAPER TO FEMALE BSP PARALLEL**

Transair®	C1	C2	F	L	Kg
EF04 01 02	R1/4	G1/8	14	16	0.010
EF04 02 03	R3/8	G1/4	17	16.5	0.014
EF04 02 04	R1/2	G1/4	22	19.5	0.036
EF04 03 04	R1/2	G3/8	22	19.5	0.027
EF04 04 06	R3/4	G1/2	27	23.5	0.050



# CONNECTION ACCESSORIES

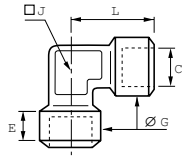

## EQUAL FEMALE ELBOW BSP PARALLEL

Transair®	C	E	G	J	L	Kg
EF12 00 04	G1/2	14	26	21	33.5	0.105

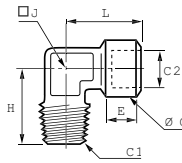

## EQUAL FEMALE STUD ELBOW BSP PARALLEL, MALE BSP TAPER

Transair®	C1	C2	E	G	H	J	L	Kg
EF13 00 02	R1/4	G1/4	11	17	23.5	13	25.5	0.034
EF13 00 04	R1/2	G1/2	14	26	31	21	33.5	0.089

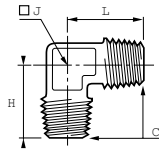

## EQUAL MALE STUD ELBOW BSP TAPER

Transair®	C	H	J	L	Kg
EF14 00 04	R1/2	31	21	31	0.070

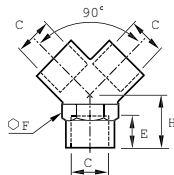

## EQUAL Y FEMALE BSP PARALLEL

Transair®	C	E	F	H	Kg
EF10 00 04	G1/2	14	25	19	0.089

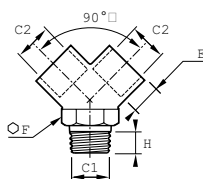

## EQUAL Y FEMALE BSP PARALLEL, MALE BSP TAPER

Transair®	C1	C2	E	F	H	Kg
EF11 00 04	R1/2	G1/2	14	25	19	0.101

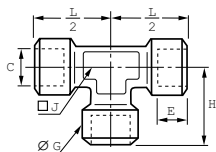

**EQUAL FEMALE TEE BSP PARALLEL**

Transair®	C	E	G	H	J	L/2	Kg
EF15 00 04	G1/2	14	26	33.5	21	33.5	0.144

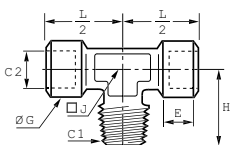

**MALE STUD BRANCH TEE, FEMALE BSP PARALLEL, MALE BSP TAPER**

Transair®	C1	C2	E	G	H	J	L/2	Kg
EF16 00 04	R1/2	G1/2	14	26	31	21	33.5	0.129

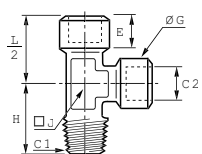

**MALE STUD RUN TEE, FEMALE BSP PARALLEL, MALE BSP TAPER**

Transair®	C1	C2	E	G	H	J	L/2	Kg
EF17 00 02	R1/4	G1/4	11	17	23.5	13	25.5	0.051
EF17 00 04	R1/2	G1/2	14	26	31	21	33.5	0.127

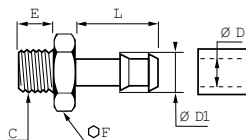

**TAILPIECE ADAPTOR FOR PVC HOSE MALE BSP PARALLEL**

Transair®	ØD	ØD1	C	E	F	L	Kg
EF26 06 01	6	7	G1/8	6	12	20	0.009
EF26 06 02	6	7	G1/4	8	17	21	0.013
EF26 08 02	8	9	G1/4	8	17	21	0.014
EF26 08 03	8	9	G3/8	9	19	21	0.023
EF26 10 02	10	12	G1/4	8	14	20	0.016
EF26 10 03	10	12	G3/8	9	19	20	0.024
EF26 10 04	10	12	G1/2	10	22	20	0.032
EF26 13 02	13	15	G1/4	8	17	21	0.029
EF26 13 03	13	15	G3/8	9	19	22	0.027
EF26 13 04	13	15	G1/2	10	24	25	0.041
EF26 16 03	16	18	G3/8	9	19	21	0.037
EF26 16 04	16	18	G1/2	10	24	25	0.043
EF26 20 06	20	20	G3/4	13	22	37	0.087
EF26 25 08	25	25	G1"	15	28	37	0.130
EF26 32 10	32	32	G1"1/4	17	37	46	0.211
EF26 40 12	40	40	G1"1/2	17	43	46	0.262

Supplied with captive sealing washer. Ideally suited for use with Transair® PVC hose (page 57 of this catalogue).



# TRANSAIR® ALUMINIUM RANGE

## INSTALLATION GUIDE

### The Golden Rules of Installation 68 to 69

Installation Instructions	68
Best Practices	69

### Aluminium Pipe 70 to 75

General	70
Aluminium Pipe Section	72

### Pipe-To-Pipe & Stud Connectors 76 to 87

General	76
Connection / Disconnection	78
Practical Examples	81
Do's / Don'ts	86

### Quick Assembly Brackets 88 to 92

General	88
Fitting a Quick Assembly Bracket	89
Practical Examples	92

### Flexible Hoses 93 to 97

General	93
Network Connection	94
Do's / Don'ts	97

### Attachment and Support 98 to 103

Transair® Attachment	98
Supporting a Transair® System	102

### Practical Information 104 to 111

Z Dimensions	104
Expansion / Contraction	107
Bending Transair® Aluminium Pipe	110
Testing a Network	111



# THE GOLDEN RULES OF INSTALLATION

## Installation Instructions

### General

Prior to the installation of a Transair® compressed air distribution system, plan to install an adequate air filtration and drying system. Flexible Transair® hose can be installed at the start of the system in order to eliminate any sources of vibration and to facilitate maintenance operations.

When maintaining or modifying a Transair® system, the relevant section should be vented prior to the commencement of any work.

Installers should only use Transair® components and accessories, in particular Transair® pipe clips and fixture clamps. The technical properties of the Transair® components, as described in the Transair® catalogue, must be respected.

### Commissioning the Installation

Once the Transair® installation has been installed and prior to commissioning, the installer should complete all tests, inspections and compliance checks as stated in any contract and according to sound engineering practice and current local regulations. Final commissioning instructions are described on page 111 of this catalogue.

### Transair® Pipe and Hoses

Transair® pipe should be protected from mechanical impact, particularly if exposed to potential collision with fork-lift trucks or when sited in an environment with moving overhead loads.

Similarly, rotation of the pipe and pipe supports should be avoided.

Transair® pipe must not be welded.

Flexible Transair® hoses should be used in accordance with the recommendations of the installation guidelines of this catalogue (pages 93 to 97).

NB: for bending a Transair® aluminium pipe, please refer to page 110 of this catalogue.

### Expansion / Contraction

Expansion and contraction of the system are automatically catered for by correct installation. The system designer and installer should calculate the expansion or contraction of each Transair® line according to the recommendations in this installation guide.

### Component Assembly

Transair® components are provided with assembly instructions for their correct use - simply follow the methods and recommendations stated in this document.

### Transair® Installations - Prohibited Situations

- | Installation within a solid mass (concrete, foam, etc.), especially underground
- | The hanging of any external equipment on Transair® pipe
- | The use of Transair® for earthing or as a support for electrical equipment
- | Exposure to chemicals that are incompatible with Transair® components (please contact us for further details)
- | The use of components not approved by Transair®

## Best Practices

- | When installing a Transair® system, the work should be performed in accordance with good engineering practices.

- | Bends and bypasses represent sources of pressure drop.
- | To avoid excessive pressure loss, use modular consoles to offset the network and to bypass obstacles.
- | Keep in-line pipe diameter reductions to a minimum.

- | Maintain a consistent level of good quality air by use of adequate filtration at the compressor outlet.

- | The diameter of the pipe will influence pressure drop and the operation of point-of-use equipment.
- | Select the diameter according to the required flow rate and acceptable pressure drop at the points of use.

- | Never encase the network in order to facilitate maintenance or servicing.

- | Position drops as close as possible to the point of use.

# TRANSAIR® ALUMINIUM PIPE

## General

### PRESENTATION



Ø 16.5

DEBURRED AND  
CHAMFERED PIPE



Ø 25

DEBURRED AND  
CHAMFERED PIPE

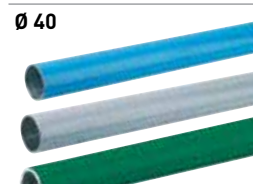

Ø 40

DEBURRED AND  
CHAMFERED PIPE



Ø 50

PIPE PRE-DRILLED  
AT EACH END  
WITH TWO 22 MM  
DIAMETER HOLES,  
DEBURRED AND  
CHAMFERED



Ø 63

PIPE PRE-DRILLED AT EACH  
END WITH TWO 22 MM  
DIAMETER HOLES,  
DEBURRED AND CHAMFERED



Ø 76

PIPE LUGGED  
AT EACH END,  
DEBURRED AND CHAMFERED

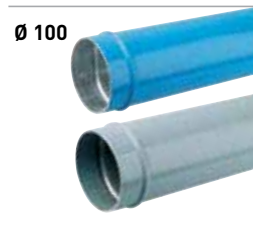

Ø 100

PIPE LUGGED  
AT EACH END,  
DEBURRED AND CHAMFERED

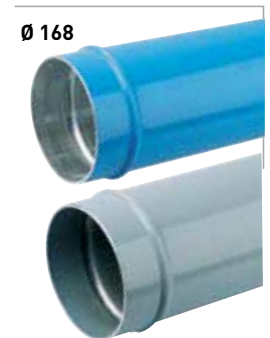

Ø 168

PIPE LUGGED  
AT EACH END,  
DEBURRED AND CHAMFERED

Transair® aluminium pipe is supplied "ready for use".

No particular preparation (cutting, deburring, chamfering, etc.) is required.

Thanks to the rigidity of Transair® aluminium pipe, temperature-related expansion / contraction phenomena are reduced to a minimum. The Transair® network retains its straightness, and hence its performance, over time (reduction of pressure drop caused by surface friction).

Transair® aluminium pipe is calibrated and fits perfectly with all Transair® components. Each connection is automatically secured and the seal is optimized.

The use of Transair® aluminium pipe minimises corrosion to the internal surface (self-protection of the pipe by the formation of alumina oxide).

Transair® aluminium pipe has a protective lacquer coating (QUALICOAT certified) and is thus protected from external aggression.

Its colour allows the network to be immediately identified and gives a clean and aesthetic overall appearance.

Standard colours available:

- blue (RAL 5012/BS1710)
- grey (RAL 7001)
- green (RAL 6029)

(please contact us for other colours)

Transair® aluminium pipe is available in 8 diameters and 2 lengths: 3 metres and 6 metres (4.5 metres for Ø16.5 - please contact us for other lengths).

### APPLICATIONS

Transair® Ø16.5 - Ø25 - Ø40 - Ø50 - Ø63 - Ø76 - Ø100 - Ø168 aluminium pipe has been specially designed for the creation of primary and secondary networks for compressed air, vacuum and inert gases (argon, nitrogen, CO<sub>2</sub>) - please contact us for other fluids

**MARKING**

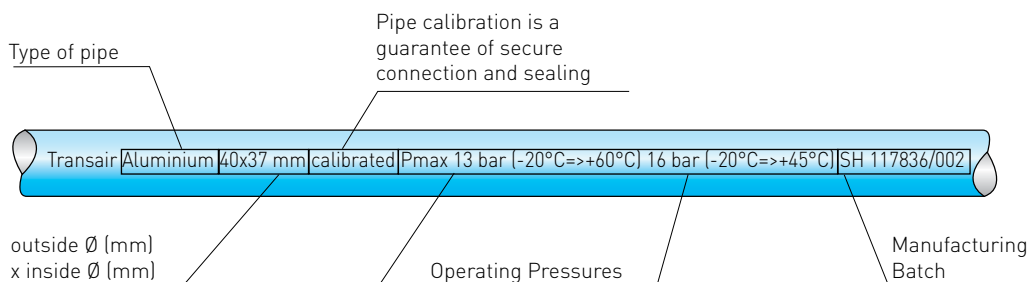

**IDENTIFICATION**

The conveyed fluid can be instantly identified by the colour of the pipe.  
 Example :  
 Blue Pipe → Compressed Air Network  
 Grey Pipe → Vacuum Network  
 Green Pipe → Nitrogen

This identification may also be done by applying adhesive labels directly onto the pipe.

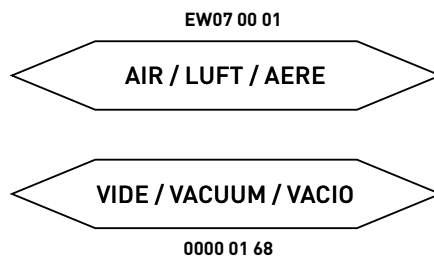

**CONNECTION INDICATOR**

**ONLY ON Ø 16.5 - Ø 25 - Ø 40 ALUMINIUM PIPE**



**DRILLING LOCATOR :  
 "MARK" LINES  
 FOR  
 CORRECT DRILLING**

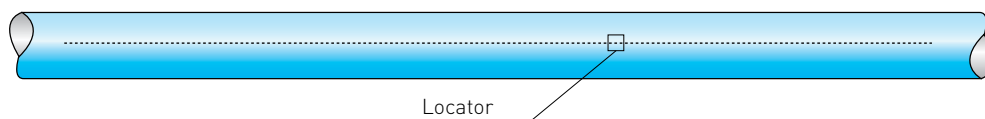

Drilling locator is used to correctly position Transair brackets onto the pipe. There are two locators on each pipe. The second locator is used to position extra brackets perpendicular to each other.



# TRANSAIR® ALUMINIUM PIPE

## Aluminium Pipe Section

Ø 16.5  
Ø 25 - Ø 40

### TOOLS



PIPE-CUTTER  
FOR ALUMINIUM PIPE  
6698 03 01



CHAMFER TOOL  
FOR ALUMINIUM PIPE  
6698 04 01



DEBURRING TOOL  
FOR ALUMINIUM PIPE  
6698 04 02



MARKING TOOL  
FOR ALUMINIUM PIPE  
6698 04 03

### PROCEDURE

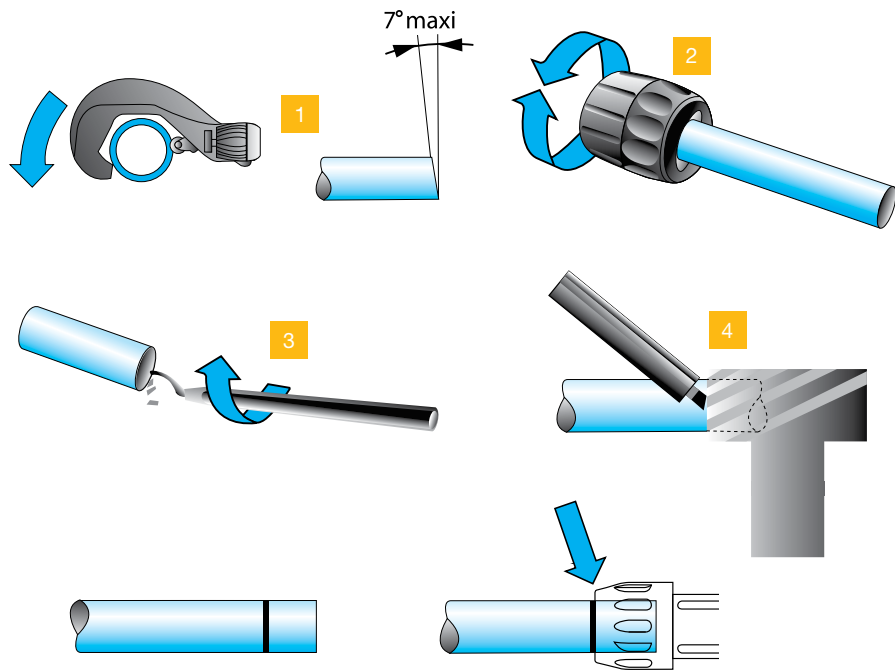

1 - Cutting the pipe:

- place the pipe in the pipe cutter
- position the blade onto the pipe
- rotate the pipe cutter around the pipe while gently tightening the wheel.

2 - Carefully chamfer the outer edges.

- 3 - Also deburr the inner end of the pipe
- 4 - Trace the connection indicator using the marking tool.

The insertion lengths for Ø16.5 - Ø25 - Ø40 connectors are 25mm, 27mm and 45mm respectively, with the exception of the end cap, ref. 6625, for which the insertion lengths are of 39mm, 42mm and 64mm respectively.

Ø 50 - Ø 63

TOOLS



PIPE-CUTTER  
6698 03 01

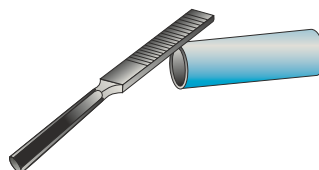

DEBURRING TOOL  
FOR ALUMINIUM PIPE  
6698 04 02



DRILLING JIG  
FOR ALUMINIUM PIPE  
6698 01 03



DRILLING TOOL  
FOR ALUMINIUM PIPE  
6698 02 01

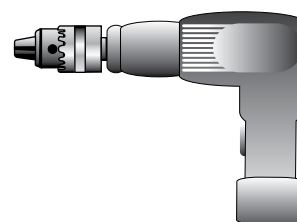

DRILL

PROCEDURE

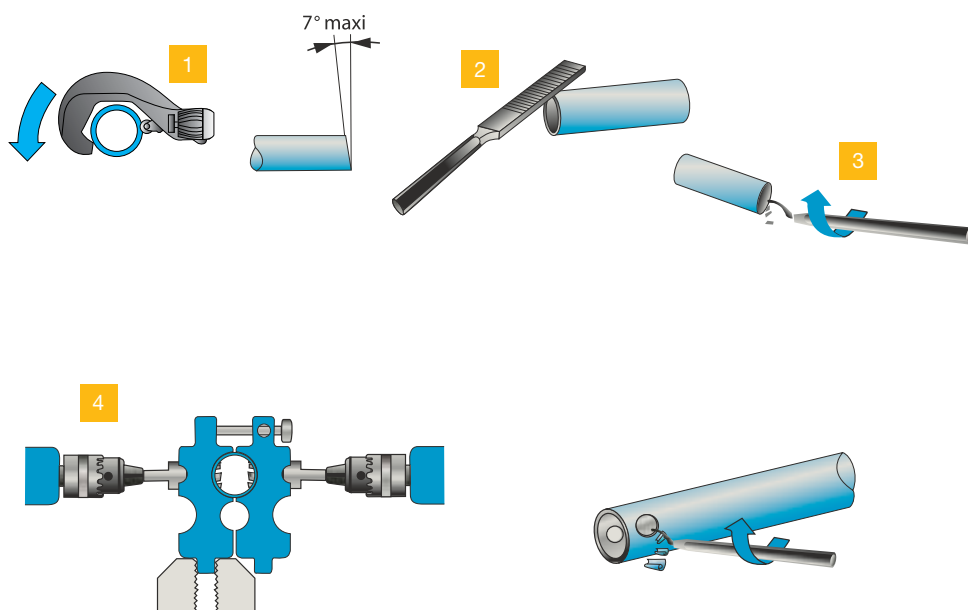

- 1 - Cutting the pipe:
  - place the pipe in the pipe cutter
  - position the blade on the pipe
  - rotate the pipe cutter around the pipe while gently tightening the wheel.
- 2 - Carefully chamfer the outer edges.
- 3 - Also deburr the inner end of the pipe

- 4 - Drill the two holes using the drilling jig (6698 01 03) and the Ø22 mm drilling tool (6698 02 01). Loosen the jig, release the pipe, then deburr both holes. Ensure that all outer and inner surfaces are smooth and clear of swarf and potential sharp edges.

# TRANSAIR® ALUMINIUM PIPE

## Aluminium Pipe Section

Ø 76 - Ø 100 - Ø168

### TOOLS



PIPE-CUTTER  
FOR ALUMINIUM PIPE  
6698 03 01 (Ø76)  
EW08 00 03  
(Ø100 AND Ø168)

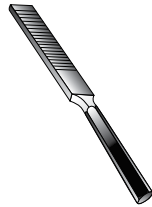

FILE



PORTABLE TOOL KIT  
REF.  
EW01 00 01 (220V) OR  
EW01 00 03 (110V)



PIPE FORMING JAW SET  
REF.  
EW02 L1 00 (Ø 76)  
EW02 L3 00 (Ø 100)  
EW02 L8 00 (Ø 168)

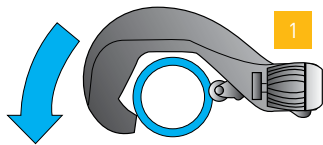

- 1 - Cutting the pipe :
- place the pipe in the pipe cutter
  - position the blade on the pipe
  - rotate the pipe cutter around the pipe while gently tightening the wheel.

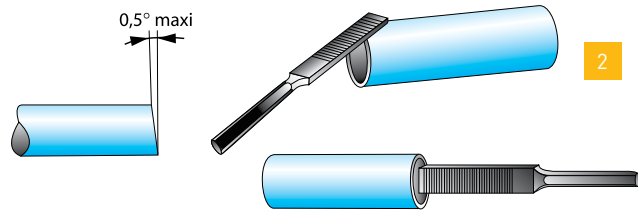

- 2 - Carefully deburr and chamfer the outer and inner edges of the pipe with a file.

- 3 Creating the lugs for Ø76, Ø100 or Ø168 cut pipe



Open the retaining pin at the front of the machine by pressing the jaw release button\*



Place the jaws in the housing.



Lock in position by closing the retaining pin.

### PROCEDURE

PROCEDURE

4

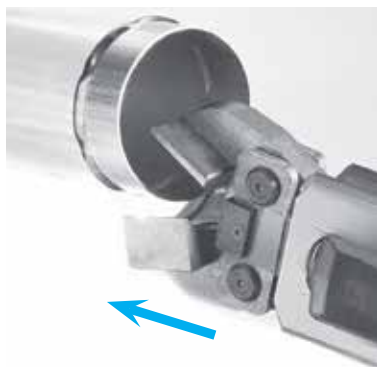

Manually open the jaws of the clamp and insert the aluminium pipe into the clamp as far as it will go.

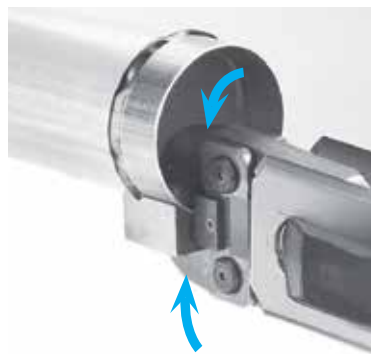

Release the jaws. Press the trigger and crimp the tube until a 'snap' sound is heard.

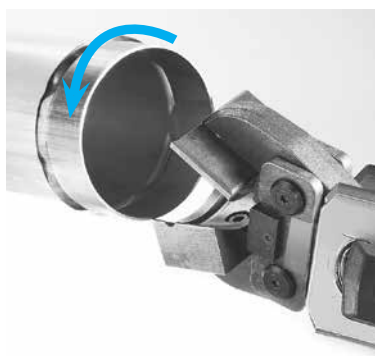

Re-open the two jaws to remove the pipe. Position the clamp end next to the lug mark: this will avoid the lugs overlapping. Rotate the pipe slightly.



Repeat the operation until the required minimum number of lugs for each diameter is achieved.

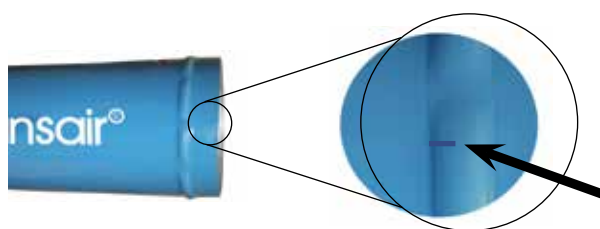

	Ø 76	Ø 100	Ø 168
Number of lugs	6	7	10

**IMPORTANT: DO NOT OVERLAP THE LUGS!**

# TRANSAIR® PIPE-TO-PIPE & STUD CONNECTORS

## General

### INSTANT CONNECTION BY MEANS OF A GRIPPING RING

Ø 16.5  
Ø 25  
Ø 40

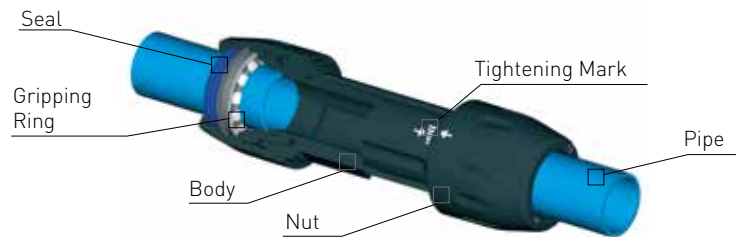

Ø16.5, Ø25 and Ø40 connectors secure instantly to Transair® aluminium pipe. Simply insert the pipe into the connector up to the connector insertion mark.

The internal gripping ring is then automatically secured and the connection is complete.

### SNAPRING QUICK-FIT CONNECTION

Ø 50  
Ø 63



Ø50 and Ø63 connectors are quickly secured to Transair® aluminium pipe by means of a SnapRing which makes the connector fully integrated with the pipe.

Connection is achieved by simply tightening the nut.

### LUG & CLAMP QUICK-FIT CONNECTION

Ø 76  
Ø 100  
Ø 168

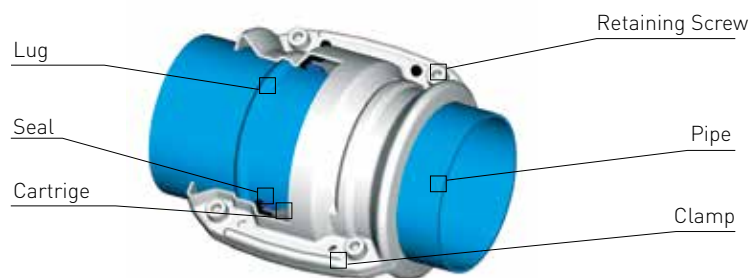

Ø76, Ø100 and Ø168 clamps secure instantly to Transair® aluminium pipe. Simply position the formed pipe within the Transair® cartridge, which acts as a seal.

Close the Transair® clamp to secure the connection and finally tighten the 4 retaining screws.

There are important visual markings on the bodies and nuts of Transair® Ø16.5, Ø25 and Ø40 connectors. These are represented by solid and empty arrows and indicate the optimum torque.

When assembling Transair® connectors, the nuts are tightened to a pre-defined torque on the body of the connector.

This torque guarantees the seal and safety of each connection.

Before using Ø16.5, Ø25 or Ø40 connectors, ensure that these arrow marks are correctly aligned with each other.

**PRE-ASSEMBLED  
TIGHTENING  
INDICATORS FOR  
Ø 16.5  
Ø 25  
Ø 40  
CONNECTORS**

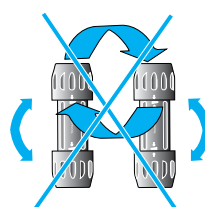
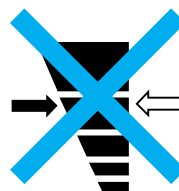
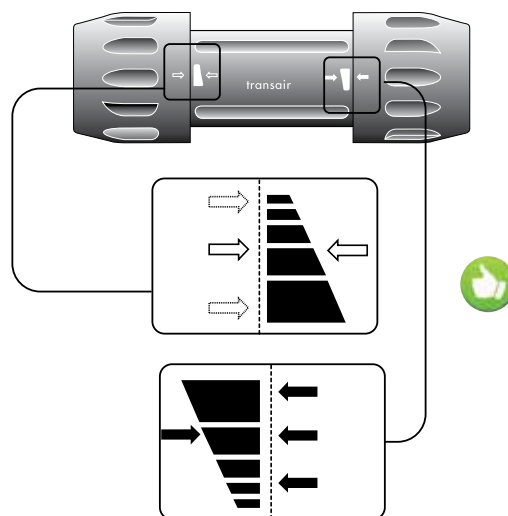

There is no need to loosen the nuts prior to joining Ø16.5, Ø25 and Ø40 connectors to Transair® aluminium pipe.

**Do not exchange the nuts.**

**Do not use a nut on another connector.**

# TRANSAIR® PIPE-TO-PIPE & STUD CONNECTORS

## Connection / Disconnection

### CONNECTION

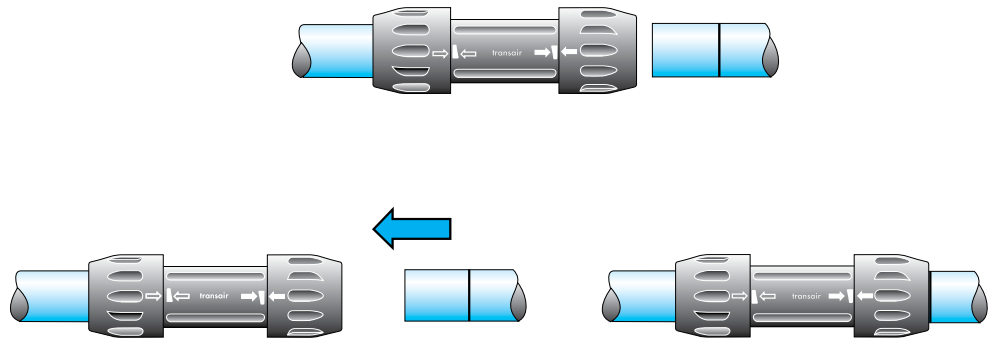

### DISCONNECTION

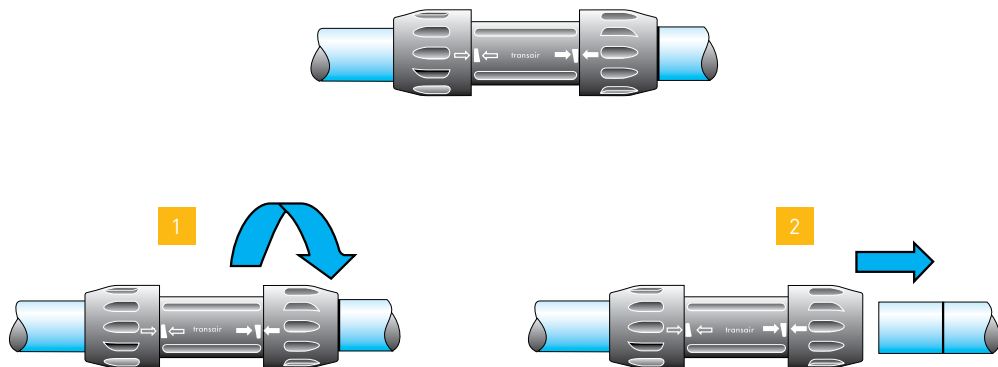

Simply insert the pipe into the connector up to the connection mark.  
To disconnect, unscrew the nut by one half turn and remove the pipe.

Lateral dismantling: see page 84 of this catalogue.

**NB – when using end caps (6625)**

The insertion length is greater for end caps than for other Transair® connectors. The connection mark should be applied to the pipe by means of a marker and tape measure, using the following values:

- Ø16.5: 39mm
- Ø25: 42mm
- Ø40: 64mm

CONNECTION

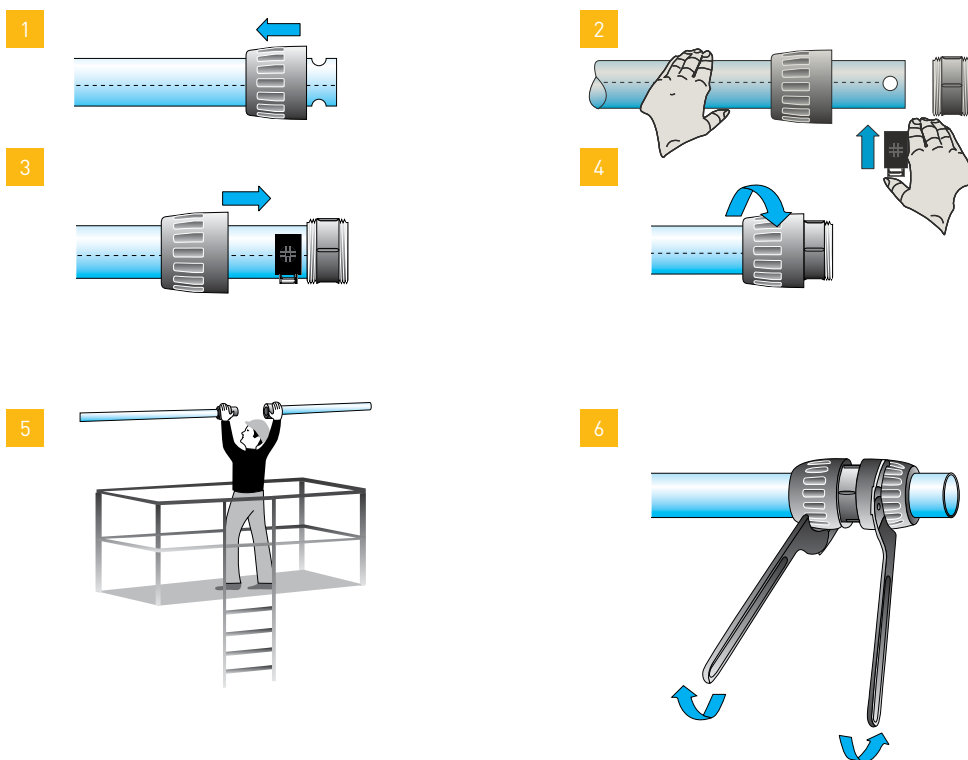

DISCONNECTION

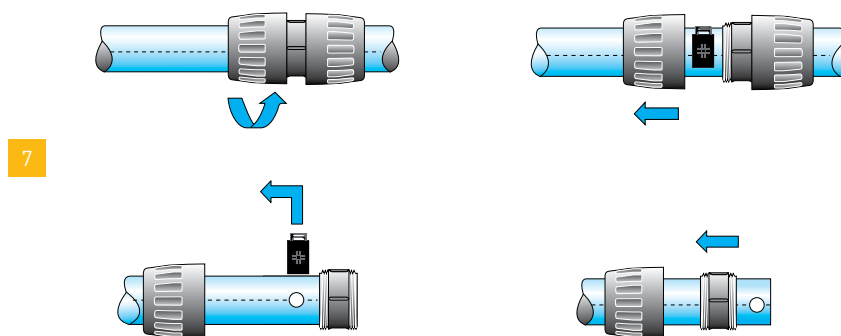

- 1 - Unscrew one of the connector nuts and fit over the pipe.
- 2 - Position the SnapRing in the appropriate housings (2 holes at the end of the pipe). Position the SnapRing manually **with one hand**.
- 3 - Bring the nut towards the body, that has been previously positioned at the end of the pipe, until it stops against the double clamp.
- 4 - Tighten the nut by hand.

- 5 - Bring the two pipes together.
- 6 - Complete the assembly by 1/2 rotation with Transair® tightening spanners ref. 6698 05 03.
- 7 - To disconnect, perform the same operations in reverse order.

Lateral dismantling: see page 84 of this catalogue.

Ø 50  
Ø 63



# TRANSAIR® PIPE-TO-PIPE & STUD CONNECTORS

## Connection / Disconnection

### CONNECTION

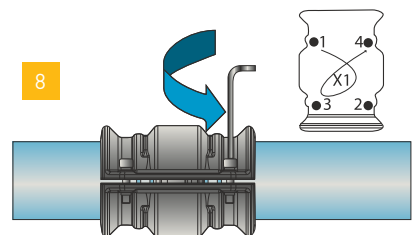
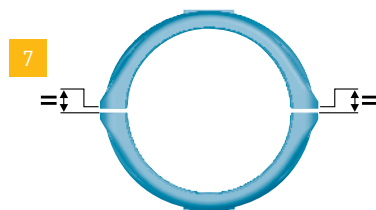
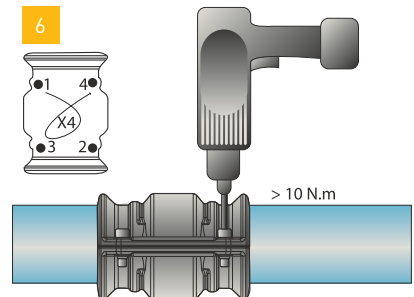
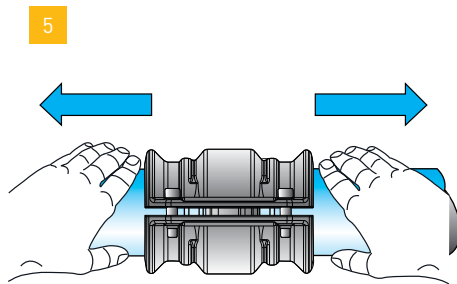
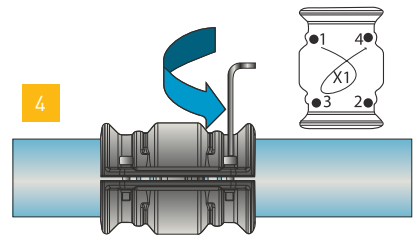
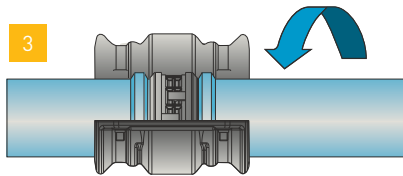
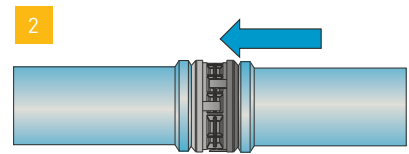
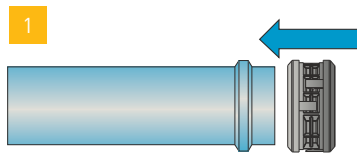
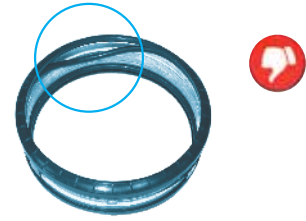

See Assembly Guide

Ø 76  
Ø 100  
Ø 168

- 1 - Slip the cartridge over the end of the first pipe fully up to the shoulder.
- 2 - Bring the second pipe to the cartridge and slide fully up to the shoulder.
- 3 - Position the clamp over the cartridge / pipe assembly.
- 4 - Hand tighten the pre-fitted screws with an Allen key (6 mm for Ø76 and Ø100, 8mm for Ø168).
- 5 - Pull the pipes fully back towards the outside of the clamp.

- 6 - Fully tighten the clamp screws.  
Mini tightening torque: 10Nm  
Maximum tightening torque: 40m.N
- 7 - For effective clamp sealing, screw tightening should be performed on alternate sides of the clamp as shown above.
- 8 - Check manually with an Allen key that the screws are correctly tightened.

To disconnect, perform the same operations in reverse order.

# Practical Examples

VARIOUS Ø76, Ø100 AND Ø168 CONFIGURATIONS	
<p><b>CHANGING DIRECTION WITH A 90° ELBOW</b></p>	<p>1 x RX02 / RA02      2 x RR01</p>
<p><b>CHANGING DIRECTION WITH A TEE PIECE</b></p>	<p>1 x RX04 / RA04      3 x RR01</p>
<p><b>CONNECTING AN END CAP</b></p>	<p>1 x RA25      1 x RR01</p>
<p><b>CONNECTING A CIRCULAR FLANGE AND A CONNECTOR</b></p>	<p>1 x EW05 1 x EW06      1 x RA30 / RA31      1 x RR01</p>
<p><b>REDUCTION</b></p>	<p>Ø 100 Ø 168      Ø 76 Ø 100      1 x RR01      1 x RX66 / RA66      1 x RR01</p>
<p><b>CONNECTING A BUTTERFLY VALVE</b></p>	<p>1 x RR01      1 x RA30 / RA31      1 x VR02 N x EW06      1 x RA30 / RA31      1 x RR01</p>
<p><b>CONNECTING A FLEXIBLE HOSE AND A CIRCULAR FLANGE</b></p>	<p>1 x EW05      1 x RA30 / RA31 N x EW06      1 x RR01      1 x FP01 / FX01</p>
<p><b>ONLY FOR RX24 L1 40, RX24 L3 40, RX24 L3 40 AND RA26 L1 40. USE A BALL VALVE INSTEAD OF A PLUG TO CLOSE THE OUTLET</b></p>	<p><del>RX24 L1 40 RX24 L3 40 RA26 L1 40</del>      6625 40 00</p> <p>RX24 L1 40 RX24 L3 40 RA26 L1 40      4092 40 00</p>

# TRANSAIR® PIPE-TO-PIPE & STUD CONNECTORS

## Practical Examples

CONNECTING A TRANSAIR® Ø76, Ø100 OR Ø168 NETWORK TO A TRANSAIR® Ø63, Ø50, Ø40, Ø25, Ø16.5 NETWORK

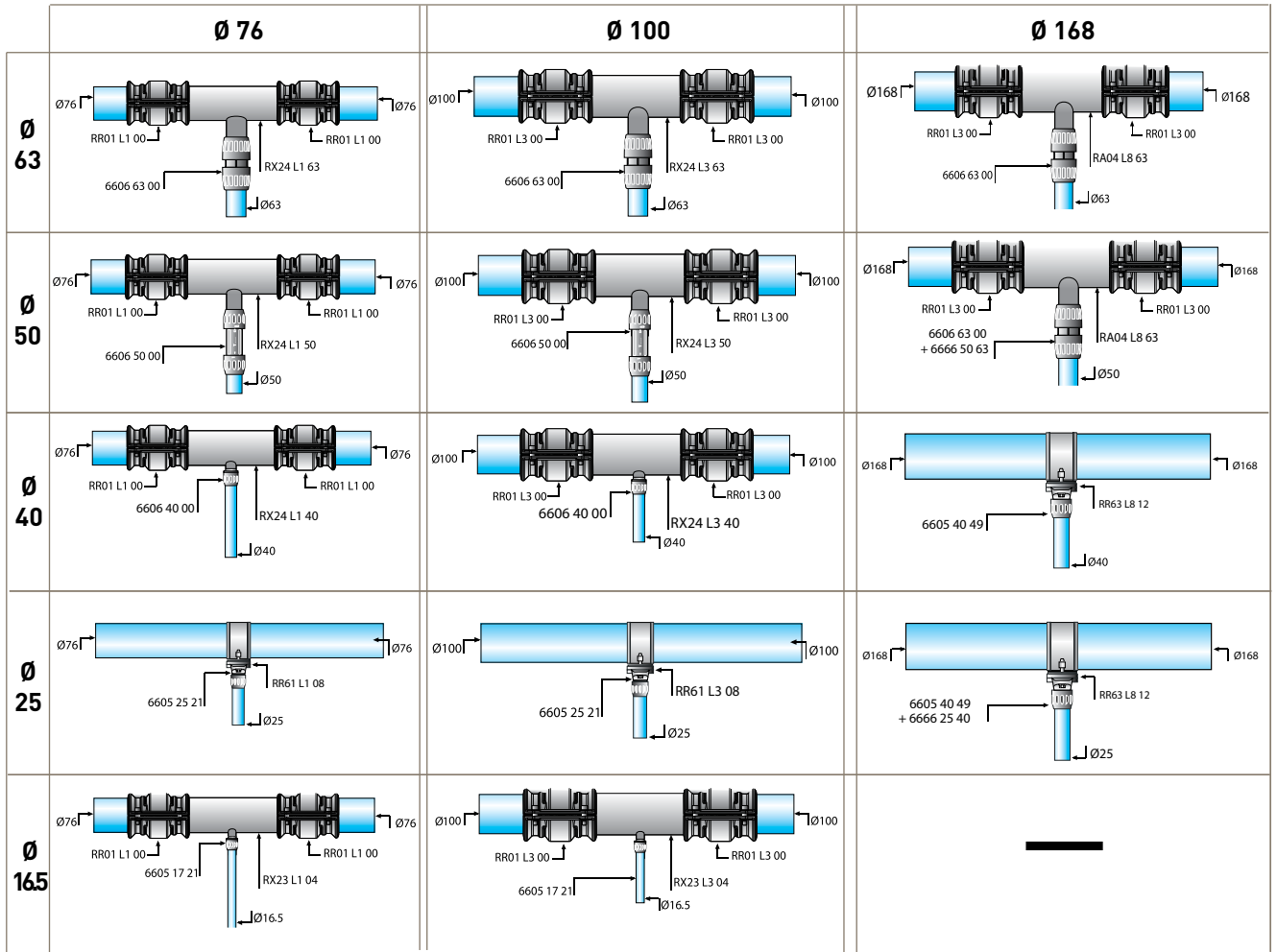

Minimum pipe centre-to-centre mounting distances for Ø76 - Ø100 - Ø168 tees

Ø D1 (mm)	Ø D2 (mm)	A (mm)	B mini (mm)
100	100	90	470
100	76	80	470
100	63	90	327
100	40	46	225
100	25	46	215
100	16.5	46	200
76	76	80	420
76	63	90	314
76	40	46	212
76	25	46	202
76	16.5	46	187

Minimum pipe centre-to-centre mounting distances for Ø76 - Ø100 - Ø168 brackets

Ø D1 (mm)	Ø D2 (mm)	A (mm)	B mini (mm)
168	50	90	510
168	40	46	410
100	25	46	250
76	25	46	240

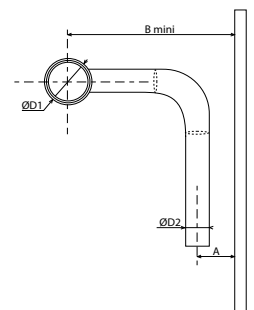

SYSTEM MODIFICATION

FOR DIAMETERS Ø16.5 - Ø25 - Ø40 ONLY

REPLACING  
A PIPE-TO-PIPE  
CONNECTOR  
WITH A TEE

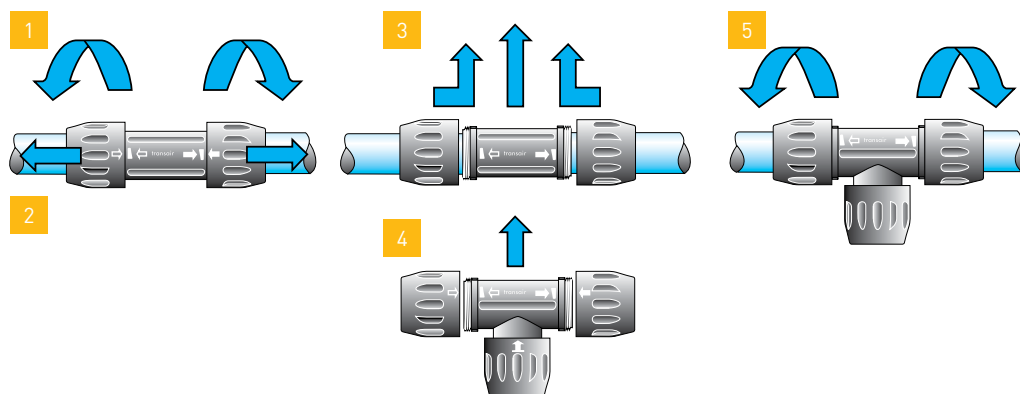

- 1 - Loosen the 2 nuts.
- 2 - Slide them along the pipe on either side of the connector.
- 3 - Remove the body of the connector, together with the nuts. Re-tighten the nuts on the body of the connector for a further use.
- 4 - Slide the nuts of the tee and position the body of the tee between the 2 pipes such that the solid and empty arrows are facing each other.
- 5 - Re-tighten the nuts until the empty and solid arrows are aligned with each other.

FOR DIAMETERS Ø16.5 - Ø25 - Ø40 ONLY

REPLACING  
A PIPE-TO-PIPE  
CONNECTOR  
WITH A BALL VALVE

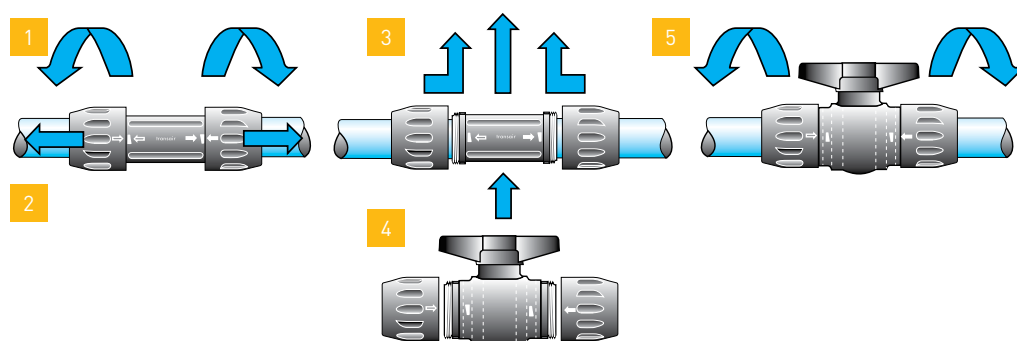

- 1 - Loosen the 2 nuts.
- 2 - Slide them along the pipe on either side of the connector.
- 3 - Remove the body of the connector, together with the nuts. Re-tighten the nuts on the body of the connector for a further use.
- 4 - Slide the nuts of the valve and position the body of the valve between the 2 pipes so that the empty and solid arrows are facing each other.
- 5 - Re-tighten the nuts until the empty and solid arrows are aligned with each other.

# TRANSAIR® PIPE-TO-PIPE & STUD CONNECTORS

## Practical Examples

LATERAL  
DISMANTLING

Ø 16.5  
Ø 25  
Ø 40

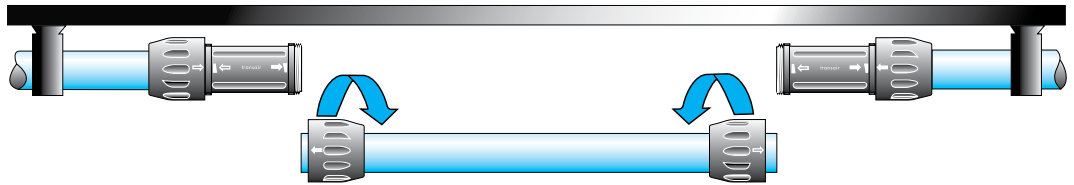

Loosen the nuts located on the side of the pipe to be removed and slide them along the pipe. Then remove the pipe.

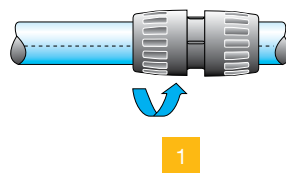

1

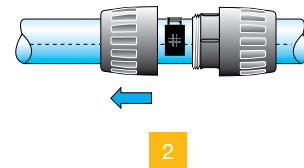

2

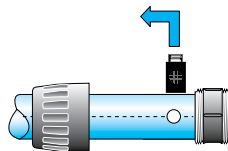

3

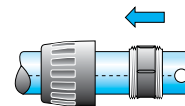

4

Ø 50  
Ø 63

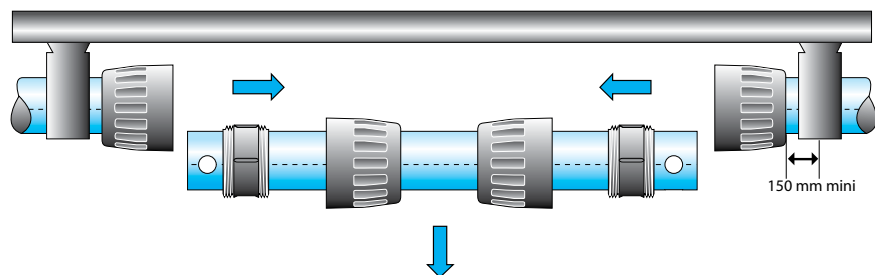

- 1 - Loosen the connector nuts on the ends of the pipe to be removed
- 2 - Slide them along the pipe.
- 3 - Remove the SnapRing from its housings.
- 4 - Slide the SnapRing and the connector body along the pipe which is to be removed.
- 5 - Repeat the operation at the other end of the pipe and laterally remove the pipe, complete with the assembly components.

**TRANSAIR®  
Ø 40  
SHUT-OFF VALVE**

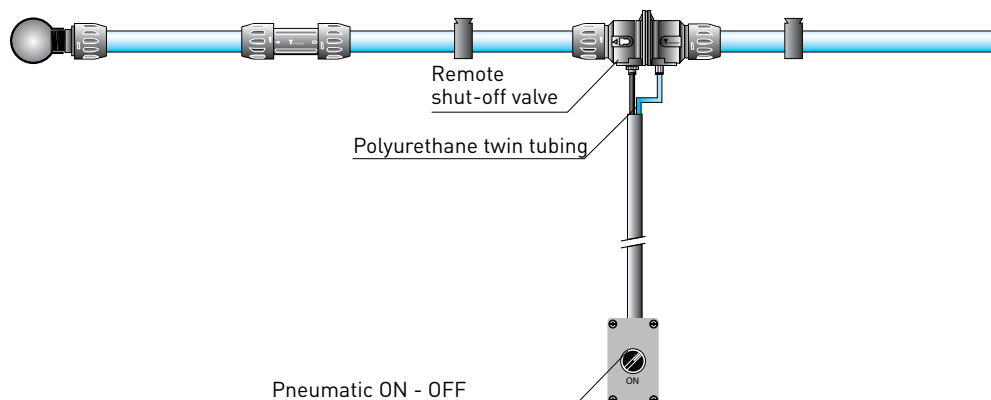

**APPLICATION**

Assembled by simple and fast connection to aluminium pipe, the Transair® Ø40 remote shut-off valve allows network supply to be rapidly and safely opened and closed either at ground level or by remote control.

The Transair® remote shut-off valve thus guarantees :

- Personal safety, by eliminating all hazards related to working at heights.
- Servicing speed, by removing the need for special access equipment (ladder, platform etc)

**OPERATING PRINCIPLE**

Single acting valve - normally closed.

**For compressed air networks:**

the valve control pressure can be taken upstream of the isolating valve, with no external power supply. Control is performed through the control unit connected to the valve by means of a push-in connector.

**For vacuum networks:**

a compressed air supply external to the control unit is required, and the corresponding valve port must be closed in order to prevent loss.

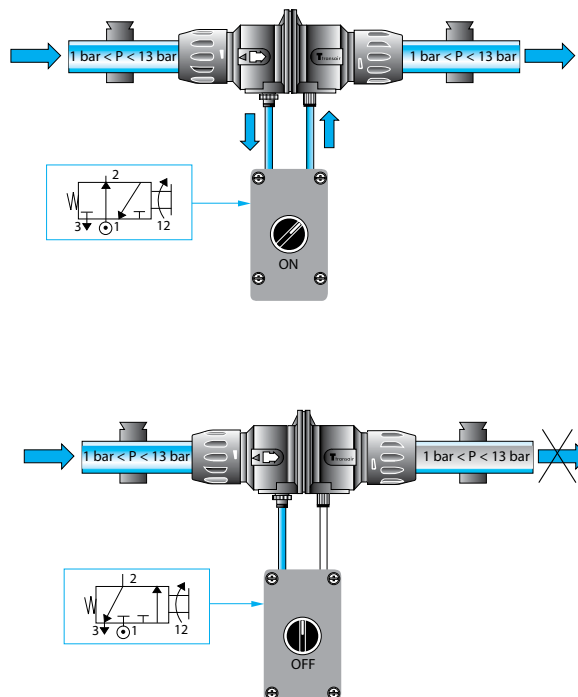

# TRANSAIR® PIPE-TO-PIPE & STUD CONNECTORS

## Do's

Ø 16.5 - Ø 25 - Ø 40



CONNECTION

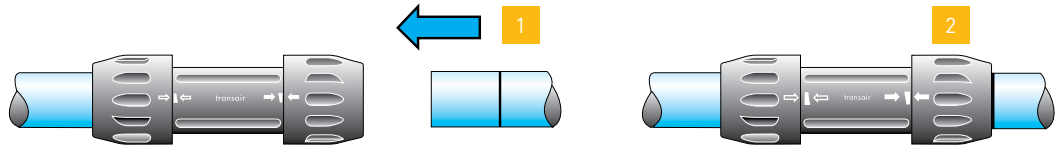

USE A PIPE CUTTER

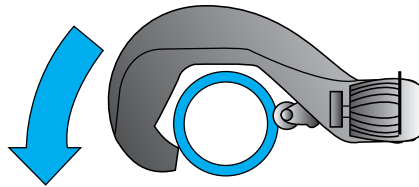

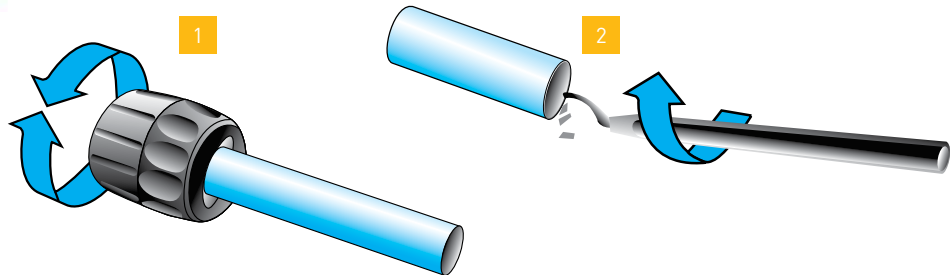

CAREFULLY CHAMFER  
AND DEBURR  
THE PIPE  
AFTER CUTTING  
OR DRILLING

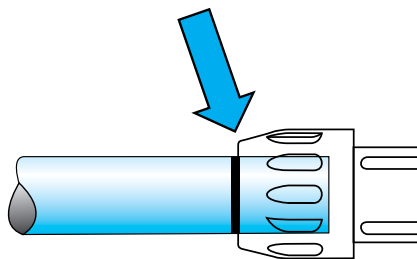

CHECK THAT THE PIPE  
IS CORRECTLY  
POSITIONED  
IN THE  
CONNECTOR

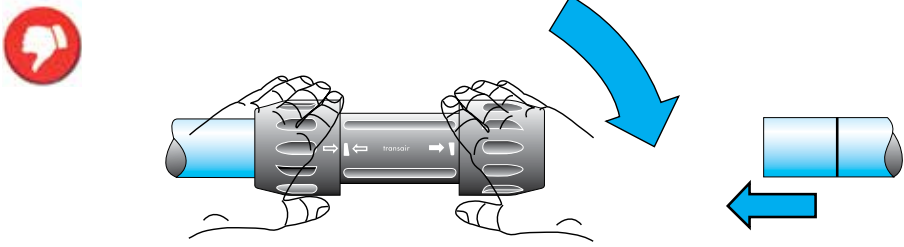
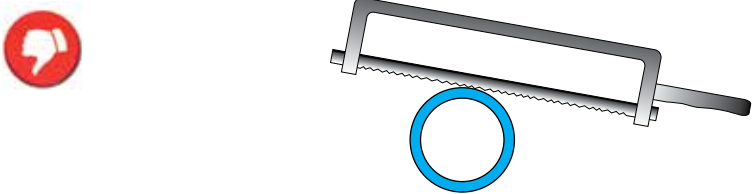
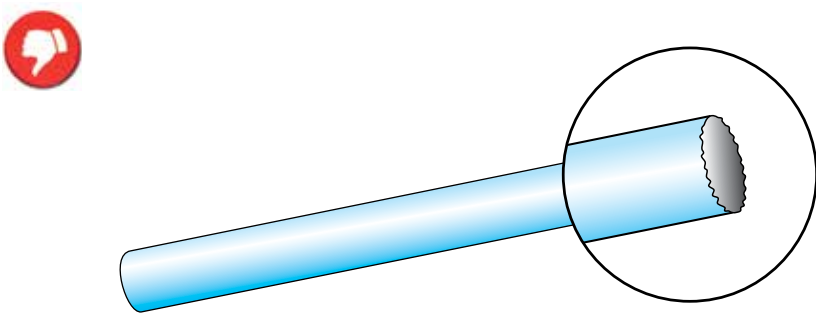
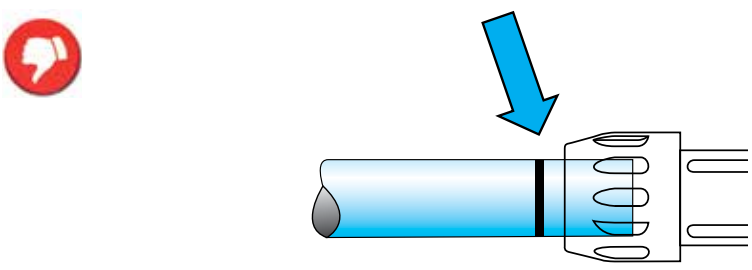
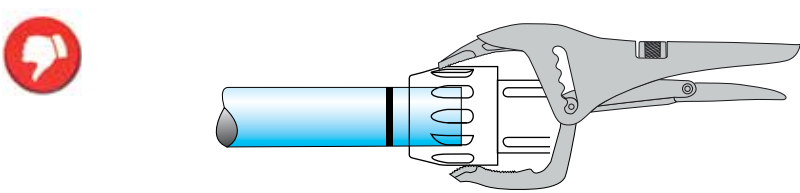

# Don'ts

<p>Ø 16.5 - Ø 25 - Ø 40</p>	
<p><b>DON'T LOOSEN THE NUTS DURING ASSEMBLY</b></p>	
<p><b>DON'T CUT THE PIPE WITH A SAW</b></p>	
<p><b>DON'T USE NON-DEBURRED PIPE</b></p>	
<p><b>DON'T FAIL TO MAKE THE PIPE SECURE</b></p>	
<p><b>DON'T OVERTIGHT WITH PLIERS DON'T SCREW BEYOND THE MARKS</b></p>	
<p><b>DON'T SWOP THE NUTS OF A CONNECTOR DON'T USE A NUT ON ANOTHER CONNECTOR</b></p>	



# TRANSAIR® QUICK ASSEMBLY BRACKETS

## General

The easy addition of a new drop or bypass onto an existing length of pipe is an important consideration for any air pipework system.

Transair® quick assembly brackets are designed for this very purpose, without the need to cut the pipe.

A "swans neck" built into the brackets retains condensate water in the main line. Thanks to its small size, the Transair® quick assembly bracket facilitates new additions in the tightest places and can be used for connecting horizontal branch lines and vertical drops..

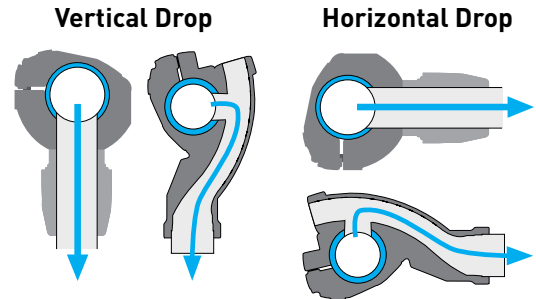

### SPECIFIC INSTRUCTIONS FOR FITTING A BRACKET

TO  
Ø 25  
Ø 40  
Ø 50  
Ø 63  
PIPE

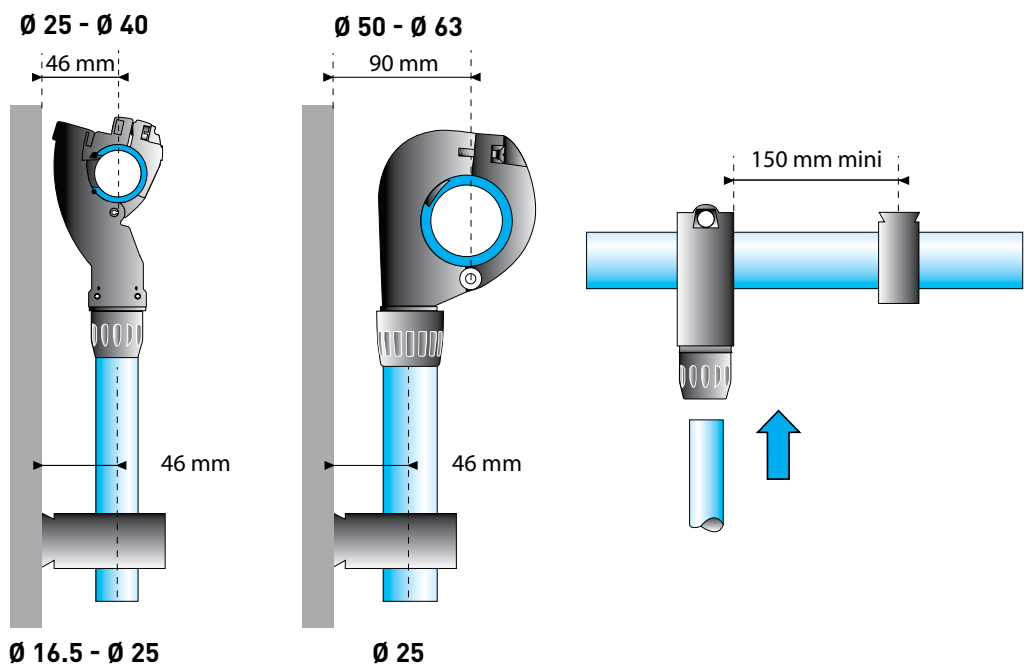

For Ø25 and Ø40 Transair® quick assembly brackets, the pipe centre to wall distance is equal to the bracket centre to wall distance, i.e. 46mm.

For Ø50 and Ø63 Transair® quick assembly brackets the pipe centre to wall distance is 90mm and the Ø25 and Ø40 bracket centre distance is 46mm.

Furthermore, Transair® clips should be fitted at a distance of at least 150mm from a quick assembly bracket in order to allow for the expansion / contraction of aluminium pipe

# Fitting a Quick Assembly Bracket

<p><b>TO</b>          Ø 25          Ø 40          Ø 50          Ø 63          PIPE</p>	
<p><b>TOOLS REQUIRED</b></p>	<p>DRILLING TOOL FOR ALUMINIUM PIPE 6698 02 02 FOR Ø25 AND 6698 02 01 FOR Ø40, Ø50 AND Ø63.</p> <p>DRILL</p> <p>DRILLING JIG FOR ALUMINIUM PIPE 6698 01 03</p> <p>DEBURRING TOOL FOR ALUMINIUM PIPE 6698 04 02</p> <p>PERMANENT MARKER PEN</p>

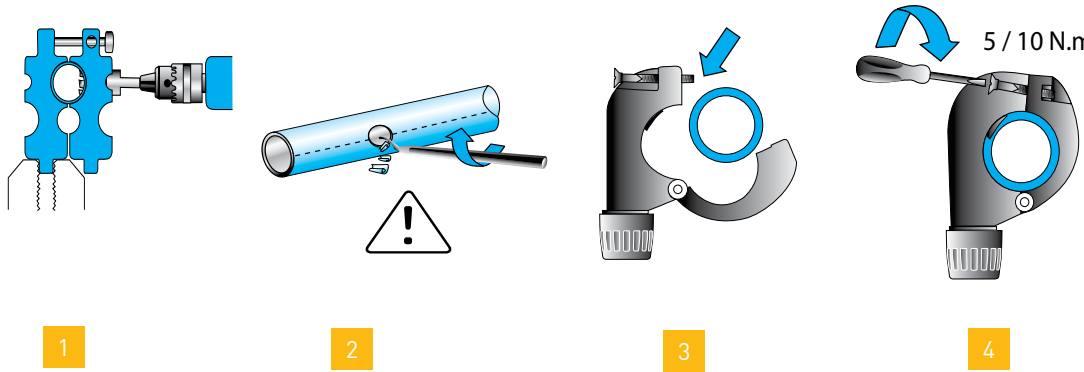
<p><b>PROCEDURE</b></p>	 <ol style="list-style-type: none"> <li>1 - Mark the pipe at the desired position for the bracket, using the locator mark when several take-off points need to be aligned uniformly. Place the drilling jig ref. 6698 01 01 in a vice or on the floor. To drill a Ø40 hole, remove the retaining bolt in the jig using an allen key and place the pipe in the jig. The locator mark on the pipe should be aligned with the appropriate guide marks on the side of the jig. Two guide lines on either side of the jig provide a rapid indication of whether the pipe is correctly positioned (the guide lines match the locator marks on the pipe). Close the jig and drill a hole using the appropriate drilling tool:             <ul style="list-style-type: none"> <li>• Ø25: Ø16 hole &gt; ref. 6698 02 02 drilling tool</li> <li>• Ø40 - Ø50 - Ø63: Ø 22 hole &gt;ref. 6698 02 01 drilling tool</li> </ul> </li> <li>2 - Release the pipe, deburr and remove any swarf and the cut circular piece of pipe. Repeat the operation for the number of brackets that you wish to fit.</li> <li>3 - Position the quick assembly bracket using its location pin.</li> <li>4 - Tighten the nut with an Allen key 5mm.</li> </ol> <p>Recommended rotation speed: 650 rpm          NB: drill without lubrication.</p>
-------------------------	----------------------------------------------------------------------------------------------------------------------------------------------------------------------------------------------------------------------------------------------------------------------------------------------------------------------------------------------------------------------------------------------------------------------------------------------------------------------------------------------------------------------------------------------------------------------------------------------------------------------------------------------------------------------------------------------------------------------------------------------------------------------------------------------------------------------------------------------------------------------------------------------------------------------------------------------------------------------------------------------------------------------------------------------------------------------------------------------------------------------------------------------------------------------------------------------------------------------------------------------------------------------------------------------------------------------------------------------------------------------------------------------------------

# TRANSAIR® QUICK ASSEMBLY BRACKETS

## Fitting a Bracket

ON  
Ø 76  
Ø 100  
Ø 168  
PIPE

### TOOLS REQUIRED

DRILLING TOOLS  
FOR ALUMINIUM PIPE  
EW09 00 30  
EW09 00 51  
EW09 00 64  
EW09 00 70  
EW09 00 90

DEBURRING TOOL  
FOR ALUMINIUM PIPE  
6698 04 02

DRILL

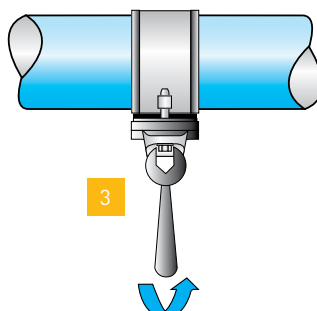
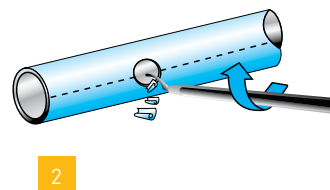
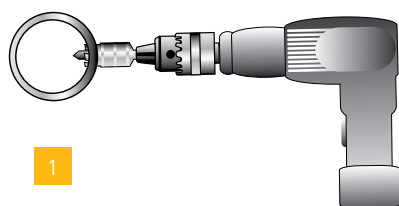
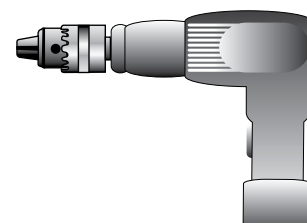

### PROCEDURE

- 1 - Drill the aluminium pipe at the desired position using drilling tool:
  - Ø76 - Ø 100: female thread 1" > drilling tool **EW09 00 30**
  - Ø168: female thread 1"1/2 > drilling tool **EW09 00 51**
  - Ø168: female thread 2" > drilling tool **EW09 00 64**
  - Ø168: female thread 2"1/2 > drilling tool **EW09 00 70**
  - Ø168: female thread 3" > drilling tool **EW09 00 90**

- 2 - Carefully deburr the pipe and remove the aluminium cut and the chips.
- 3 - Position bracket RR61 / RR63 and fully tighten the 2 screws.

Tightening torque 50 N.m

CREATING  
VERTICAL AND  
HORIZONTAL  
TAKE-OFF POINTS

USING THE SAME LOCATOR MARK

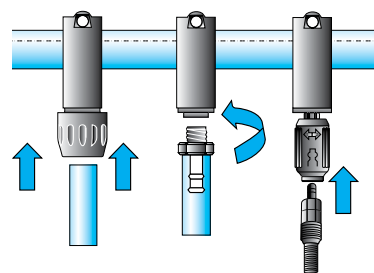
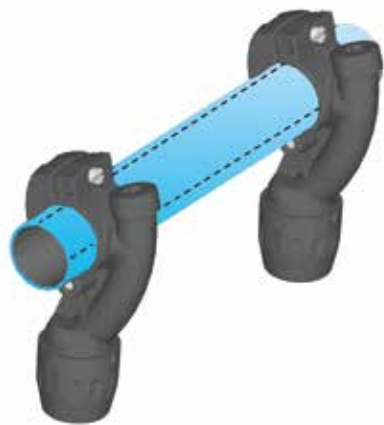

ADDING A VERTICAL  
BRACKET

USING 2 LOCATOR MARKS

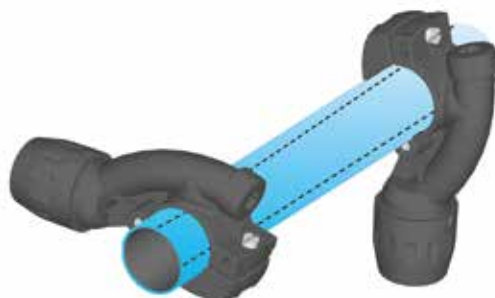

ADDING  
AN OFF-SET  
BRACKET

# TRANSAIR® QUICK ASSEMBLY BRACKETS

## Practical Examples

### FITTING A BRACKET TO A PRESSURISED SYSTEM

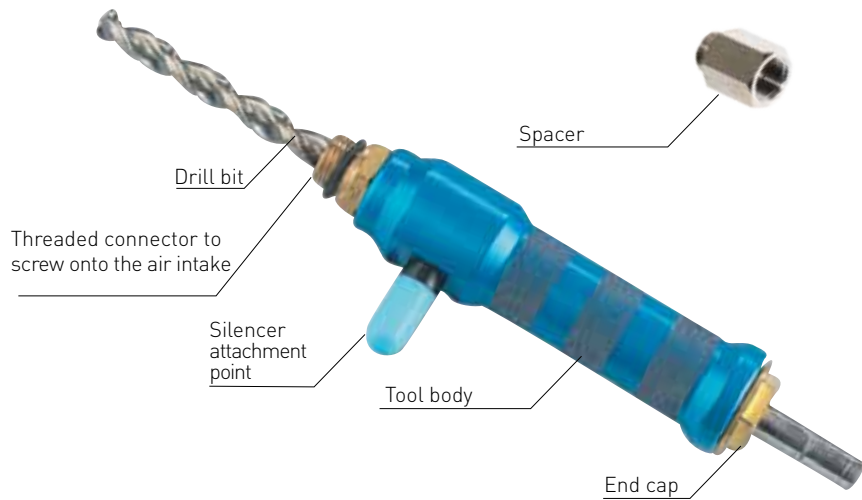

### TOOLS REQUIRED

Use the under pressure drilling tool (EA98 06 00) to fit a bracket to an existing pressurised system. This can be simply done with use of a standard drill.



- 1 - Position the pressurised system bracket and tighten with the recommended tightening torque.
- 2 - Screw the drilling tool onto the ball valve. Drill fully.

- 3 - Remove the drill and close the ball valve immediately.
- 4 - Dismantle the drilling tool.

NB: For DN25 and DN40 brackets, an additional manipulation is required between step 1 and step 2.

### PROCEDURE



- 1-1 Screw the assembly onto the ball valve. Ensure that the valve is open.

Under pressure bracket with 1/2" ball valve  
 Ø25: EA98 06 01  
 Ø40: EA98 06 02  
 Ø50: EA98 06 04  
 Ø63: EA98 06 03

# TRANSAIR® FLEXIBLE HOSES

## General

Transair® flexible hose can be easily connected to other Transair® components and can be rapidly installed without prior preparation or cutting. Thanks to its small bend radius, it requires minimum space and avoids mechanical stress within the network. Robust, Transair® flexible hose is resistant to both compressor oils and to fire.

### APPLICATIONS

Ø (mm)	Length (mm)	Part Numbers	Rmini (mm)
25	570	1001E25 00 01	100
25	1500	1001E25 00 03	100
25	2000	1001E25 00 04	100
40	1150	1001E40 00 02	400
40	2000	1001E40 00 04	400
40	3000	1001E40 00 05	400
50	1270	1001E50 00 09	280
50	2000	1001E50 00 04	280
63	1400	1001E63 00 08	300
63	3000	1001E63 00 05	650
63	4000	1001E63 00 06	650
76	1500	FP01 L1 01	350
76	2000	FP01 L1 02	350
100	2000	FP01 L3 02	450
100	3000	FP01 L3 03	450
168	3200	FX01 L8 02	900

Level change

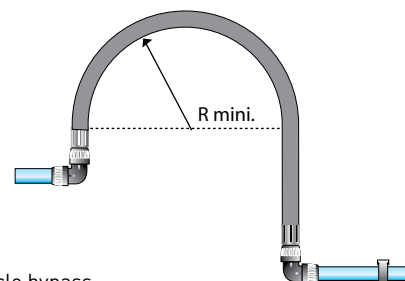

Obstacle bypass

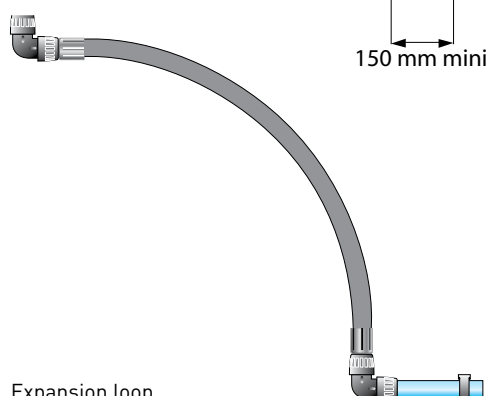

Expansion loop

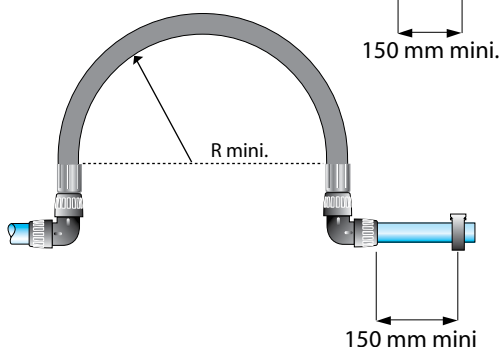

### Anti-whiplash straps



### SAFETY

In order to avoid the risk of whiplash accidents, Transair® recommends the use of anti-whiplash straps, placed on either side of the connection.

Ø25 to 100: 6698 99 03  
 Ø168: 6698 99 07

If Transair® flexible hose is exposed to tear, the anti-whiplash assembly prevents it from snapping (safety device in accordance with ISO 4414 standard).

# TRANSAIR® FLEXIBLE HOSES

## Network Connection

Ø25  
Ø40

USING  
A MALE STUD  
FITTING

- 1 - Loosen the nut on the stud fitting.
- 2 - Remove it.
- 3 - Move the swagged end of the hose onto the exposed stud thread.
- 4 - Tighten the nut.

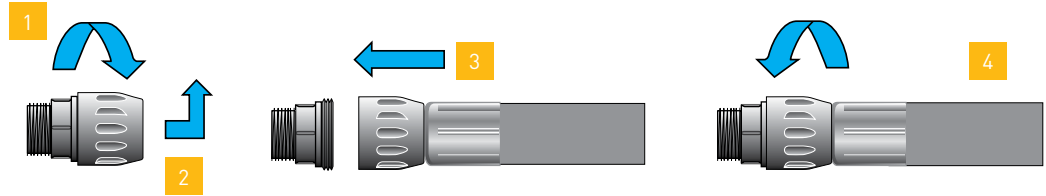

USING A  
PIPE-TO-PIPE  
CONNECTOR

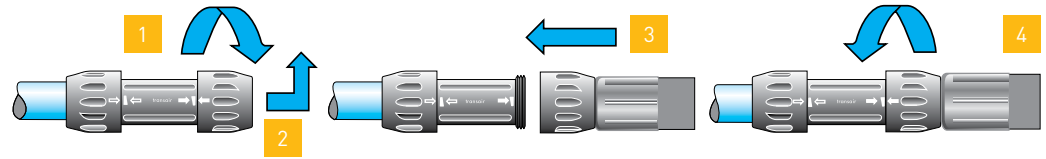

USING A 90°  
ELBOW

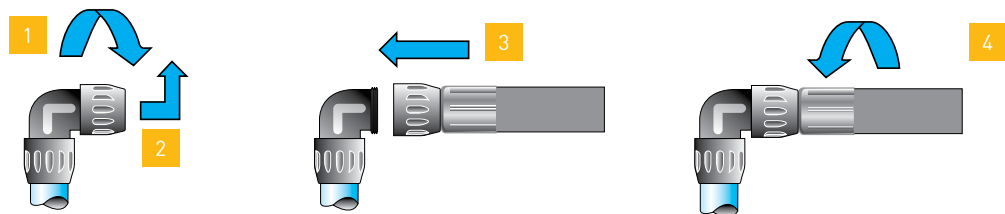

# Network Connection

Ø50 - Ø63

- 1 - Loosen the nut on the stud fitting and remove it.
- 2 - Place the nut over the swaged end of the flexible hose.
- 3 - Place the pipe connector clamps in the housings on the hose.
- 4 - Slide the nut forward to the end of the flexible hose, and assemble onto the male thread.
- 5 - Tighten the nut using 6698 05 03 spanner set.

USING  
A MALE STUD  
FITTING

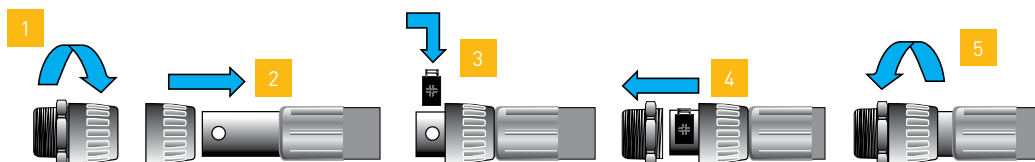

USING A  
PIPE-TO-PIPE  
CONNECTOR

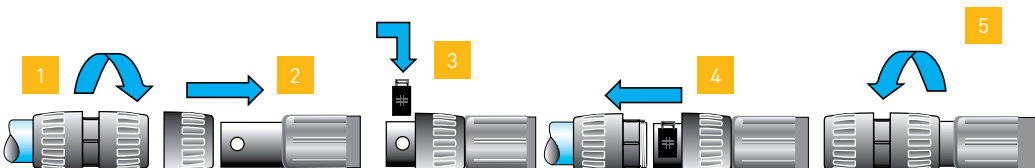

USING A 90°  
ELBOW

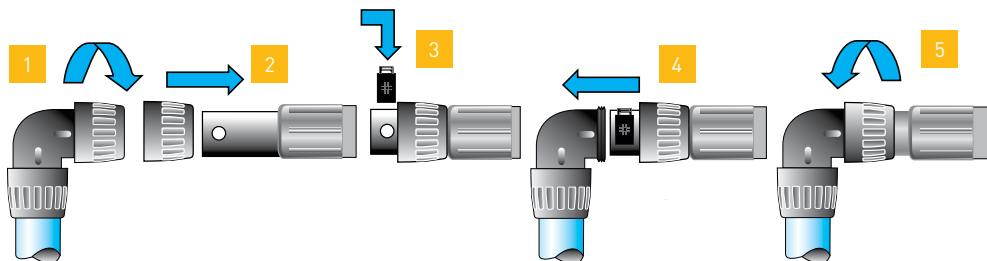



# TRANSAIR® FLEXIBLE HOSES

## Network Connection

Ø 76 - 100 - 168

USING A  
CLAMP

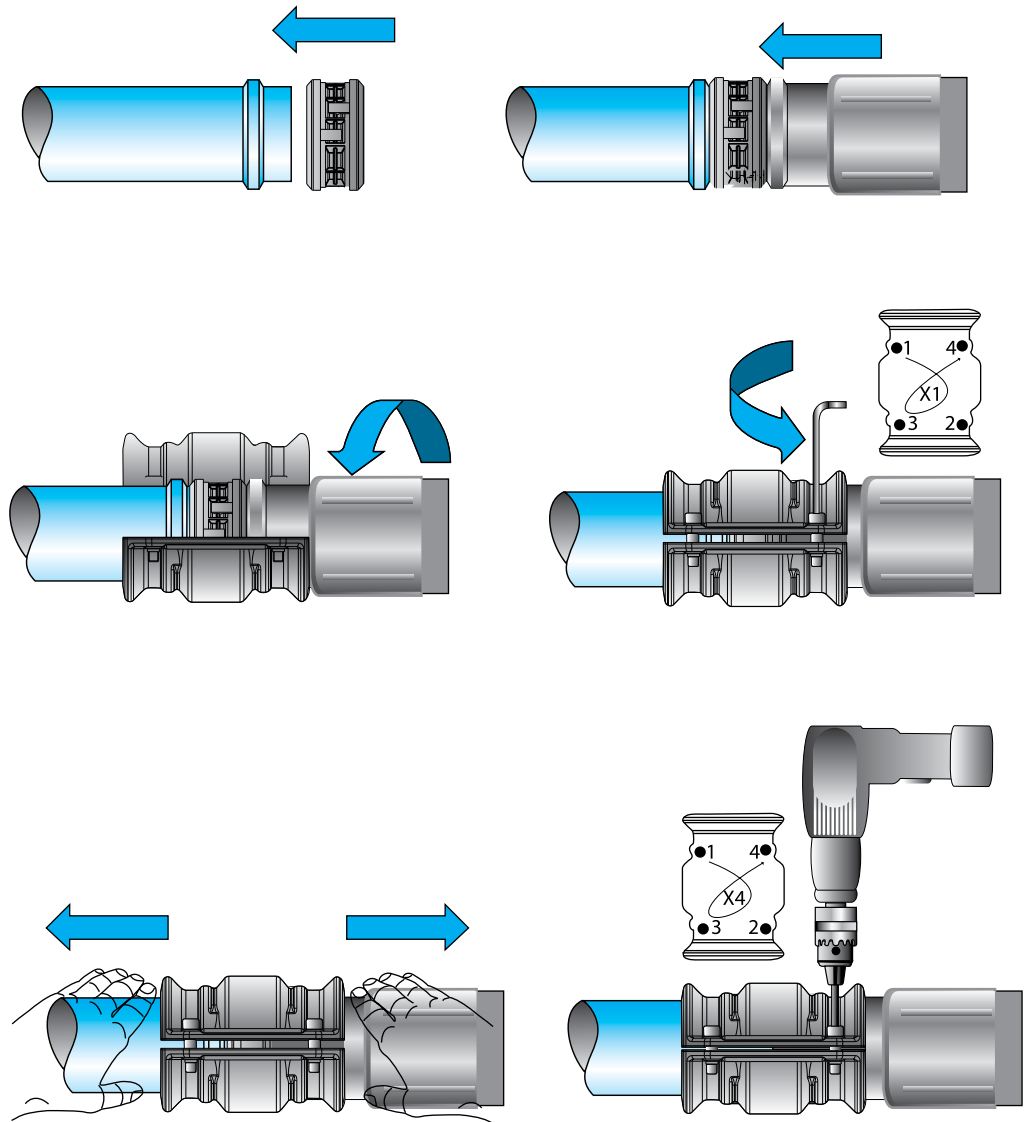

# Do's / Don'ts

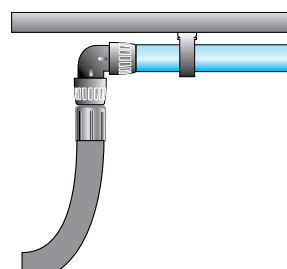
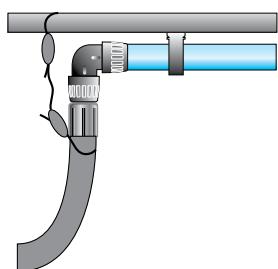
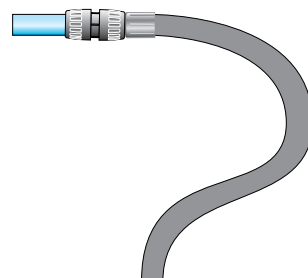
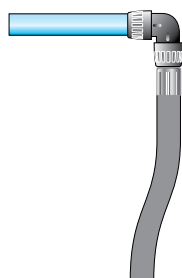
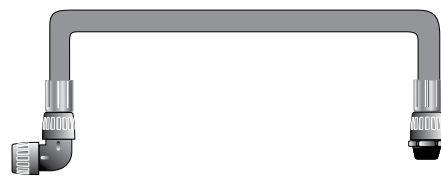
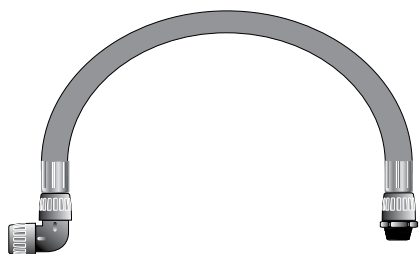
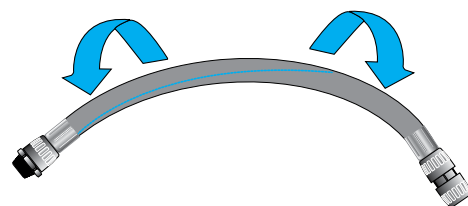
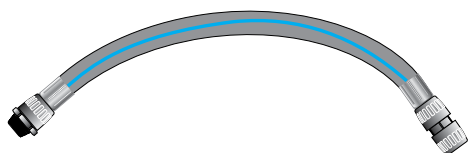
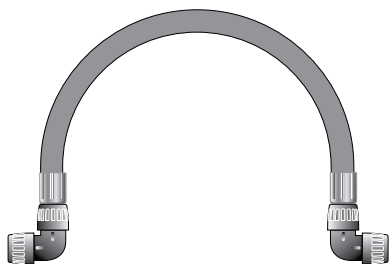
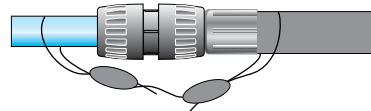

# ATTACHMENT AND SUPPORT

## Transair® Attachment

**TRANSAIR® CLIP**  
**FOR**  
**Ø 16.5**  
**Ø 25**  
**Ø 40**  
**Ø 50**  
**Ø 63**  
**RIGID PIPE**

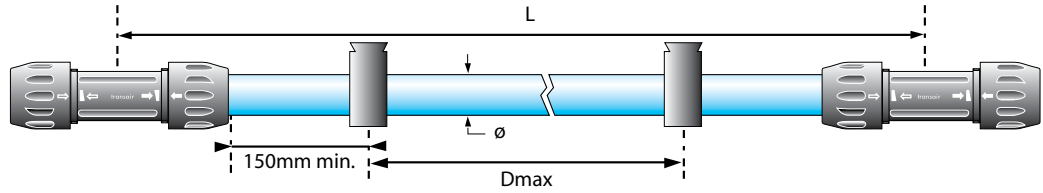

The Transair® fixing clip is the basic component for mounting pipe when installing. Ø16.5-Ø25-Ø40-Ø50-Ø63 Transair® aluminium networks. Only this clip should be used since it allows expansion and contraction of the pipe to occur freely.

To ensure good system stability, we recommend the use of at least 2 clips per pipe. Transair® aluminium pipe should only be mounted using these clips. They should not be substituted by any other type of clip or fixing.

Ø	L (m)	Dmax (m)
16.5	3	2.5
16.5	4.5	3
25	3	2.5
25	6	3
40	3	2.5
40	6	4
50	3	2.5
50	6	4
63	3	2.5
63	6	4

### PROPERTIES

- Transair® fixing clips for Ø16.5 - Ø25 - Ø40: M8 nuts
  - Transair® fixing clips for Ø50 - Ø63: M10 nuts
- The Transair® threaded rod adaptor 6697 00 02 allows Transair® pipe clips Ø16.5 - Ø25 - Ø40 to be easily suspended under M10 threaded rod.

### PROCEDURE

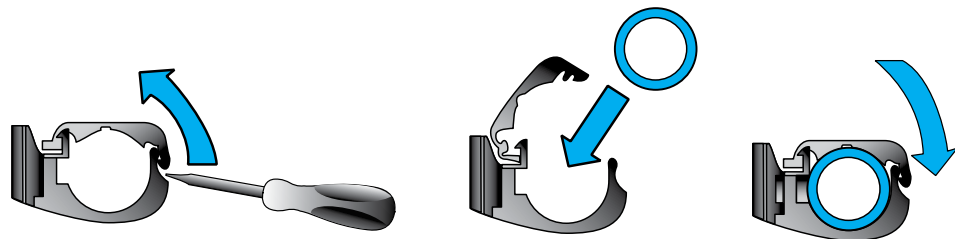

- 1 - Place the clip as required and open it using a screwdriver.
- 2 - Insert the pipe into the clip.
- 3 - Close the clip.

# Transair® Attachment

**SPACER  
FOR  
Ø16.5  
Ø25  
Ø40**

The Transair® 6697 00 03 spacer is used for fitting a run of Transair® pipe using different diameters.



**EXAMPLE:**

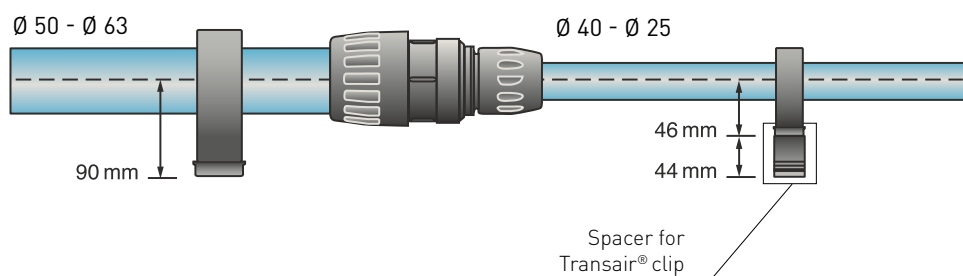

**TRANSAIR®  
FIXING CLIP  
FOR  
Ø 76  
Ø 100  
Ø 168  
NETWORKS**

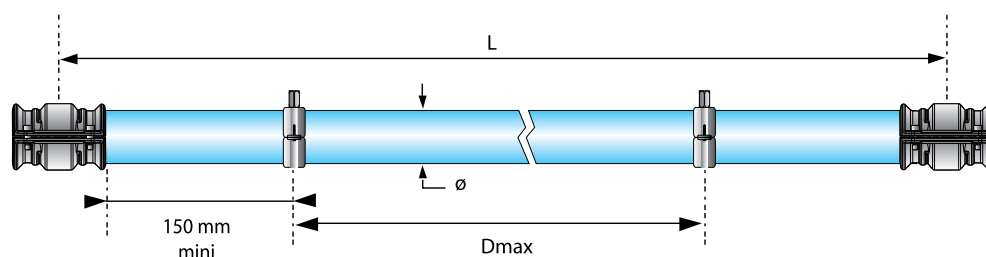

Ø	L (m)	Dmax (m)
76	3	2.5
76	6	5
100	3	2.5
100	6	5
168	3	2.5
168	6	5

To ensure good network stability, we recommend the use of at least 2 fixing clips per length of pipe. Transair® fixing clips for Ø76, Ø100 and Ø168 networks: M8/M10 thread

# ATTACHMENT AND SUPPORT

## Supporting a Transair® System

### DIRECTLY ONTO A WALL

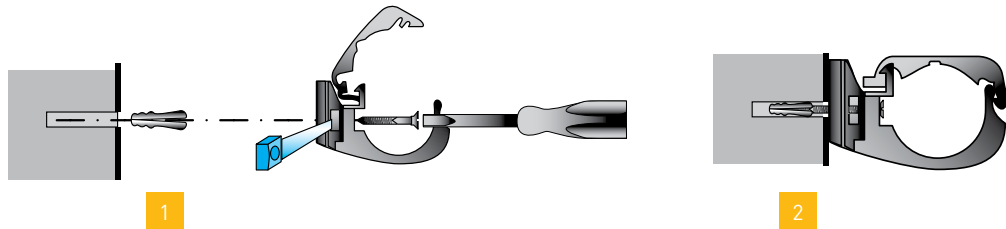

1 - Remove the nut at the base of the pipe clip using a screwdriver. Insert the screw by passing it through the clip.

2 - Tighten the screw.

### OFFSET FROM A WALL

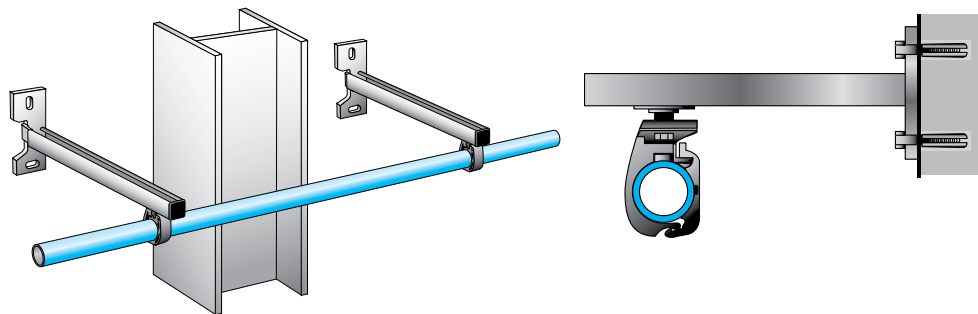

Transair® U-channel assemblies are used to offset networks and to bypass obstacles. They comprise sectional rail ref. 6699 01 01 and a series of attachment accessories 6699 01 02.

For offsetting a Ø63 / Ø76 and Ø100 air system, we recommend the use of the rail clip attachment assembly ref. 6699 01 03. .

Ø16.5, Ø25, Ø40 > Fixation clip on rail 6699 01 04

Ø50, Ø63, Ø76, Ø100 and Ø168 > Fixation clip on rail 6699 01 03

### U-CHANNEL TYPE MOUNTING BRACKET

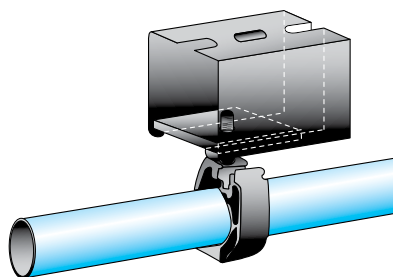

Ø50 - Ø63

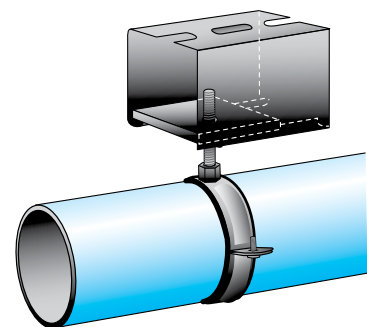

Ø76 - Ø100 - Ø168

# Supporting a Transair® System

## BENEATH A CABLETRAY

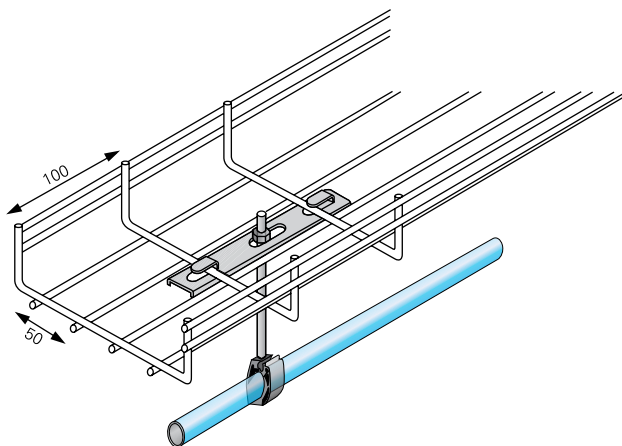

Use the under-cabletray attachment ref. 6699 10 30 and suspend with threaded rod up to M10 diameter.

This attachment can be used to suspend networks from Ø16.5 to Ø100.

## THREADED ROD ADAPTER

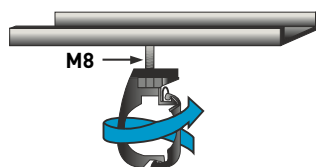

Ø 16.5 - Ø 25 - Ø 40

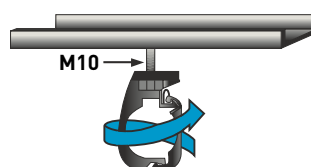

Ø 50 - Ø 63

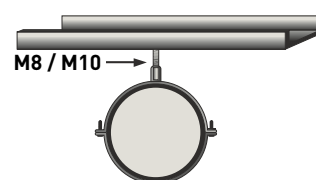

Ø 76 - Ø 100 - Ø 168

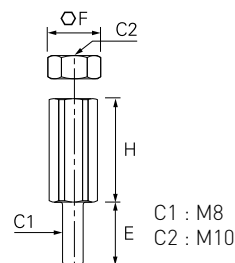

### Handy!

The Transair® threaded rod adaptor 6697 00 02 allows Ø16.5, Ø25 and Ø40 Transair® pipe clips to be easily suspended under M10 threaded rod.

# ATTACHMENT AND SUPPORT

## Supporting a Transair® System

### ON A METAL BEAM

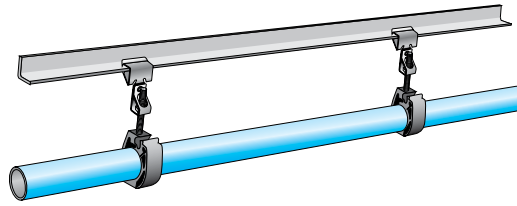

PUSH-ON TYPE BEAM CLAMP

Position the clamps ref. 6699 02 xx or ref. 669903 xx onto the RSJ or beam in accordance with the minimum recommended number of attachments per length of pipe and the required distance between attachments, according to the diameter of the pipe.

### USING BEAM CLAMPS

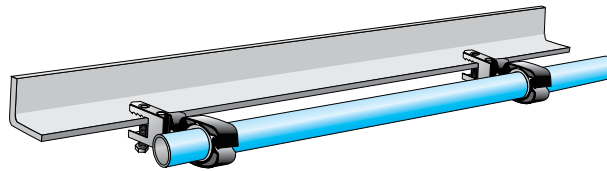

SCREW TYPE BEAM CLAMP

### U-CHANNEL BRACKETS

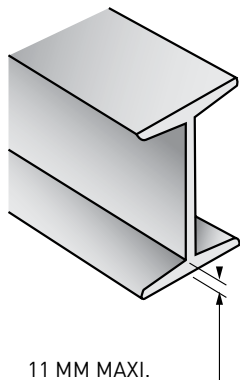

11 MM MAXI.

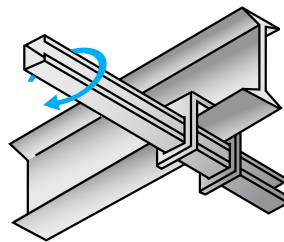

HORIZONTAL ASSEMBLY

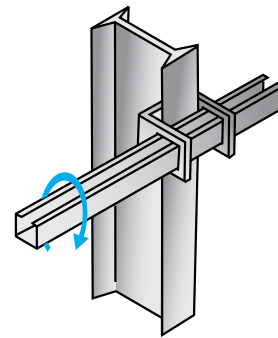

VERTICAL ASSEMBLY

Position the RSJ brackets ref. 6999 03 02 on either side of the girder profile, then slide through the U-channel sectional rail.

# Supporting a Transair® System

## UNDER CANALIS

### Canalis KN

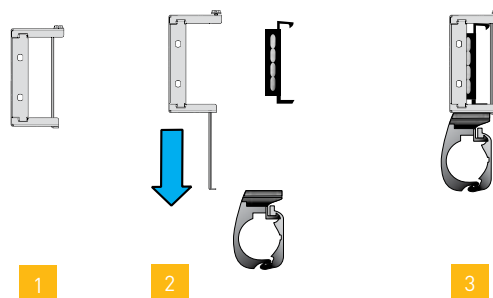
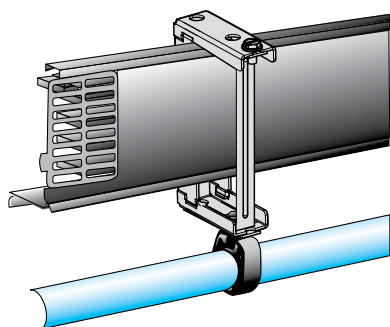

### Canalis KS

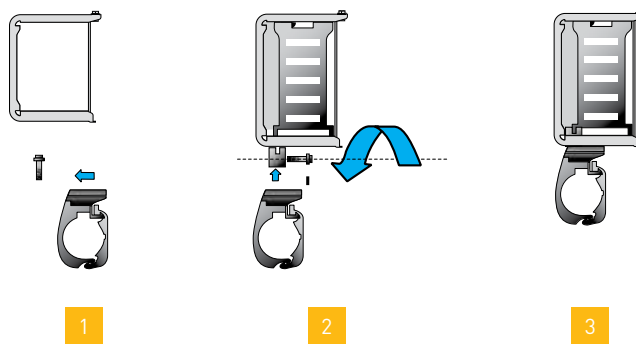

- 1 - Mount the Transair® pipe clip onto the KS attachment.
- 2 - Suspend the attachment from the Canalis® network and secure with a screw.
- 3 - The support is ready.

Canalis KN: fixture 6699 10 01  
 Canalis KS: fixture 6699 10 02



# PRACTICAL INFORMATION

## Z Dimensions

6606/6676	Z (mm)
Ø 16.5	35
Ø 25	48
Ø 40	57
Ø 50	25
Ø 63	25

6602/RX02/RA02	Z (mm)
Ø 16.5	31
Ø 25	40
Ø 40	62
Ø 50	56
Ø 63	61
Ø 76	189
Ø 100	221
Ø 168	185

6612/RX12/RA12	Z (mm)
Ø 25	32
Ø 40	45
Ø 50	38
Ø 63	37
Ø 76	122
Ø 100	138
Ø 168	147

6604	Z1 (mm)	Z2 (mm)
Ø 16.5	34	31
Ø 25	48	40
Ø 40	57	57
Ø 50	56	56
Ø 50 -> Ø 25	56	111
Ø 50 -> Ø 40	56	107
Ø 63	61	61
Ø 63 -> Ø 40	61	116
Ø 63 -> Ø 50	61	117

RA04	Z1 (mm)	Z2 (mm)
Ø 76 -> Ø100	161	149
Ø 100 -> Ø168	194	161

RA04 + 6606	Z1 (mm)	Z2 (mm)
Ø 63-> Ø76	224	142

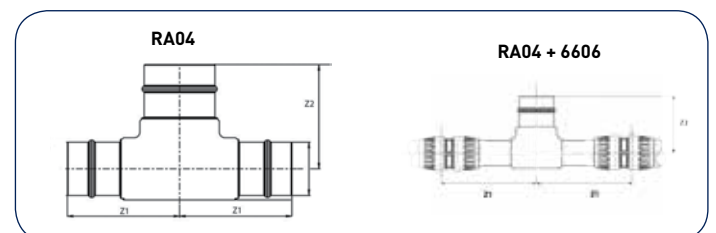
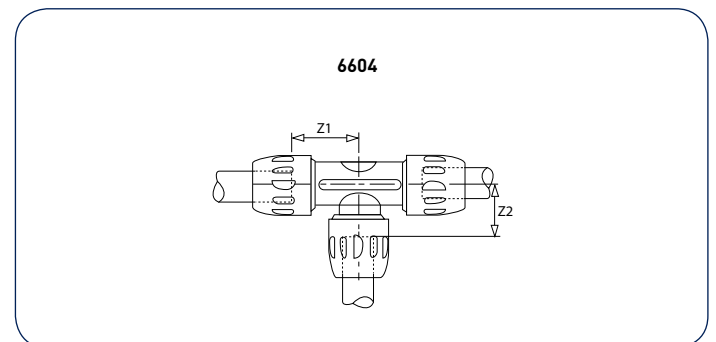
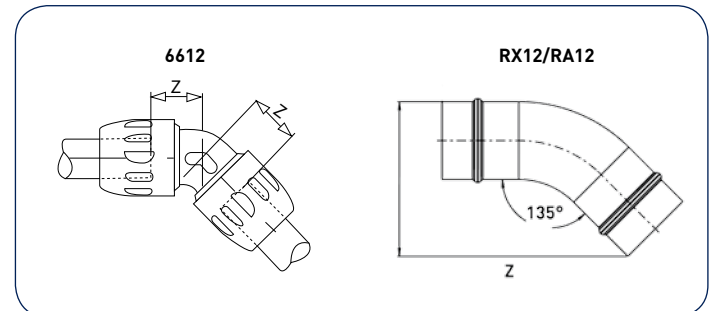
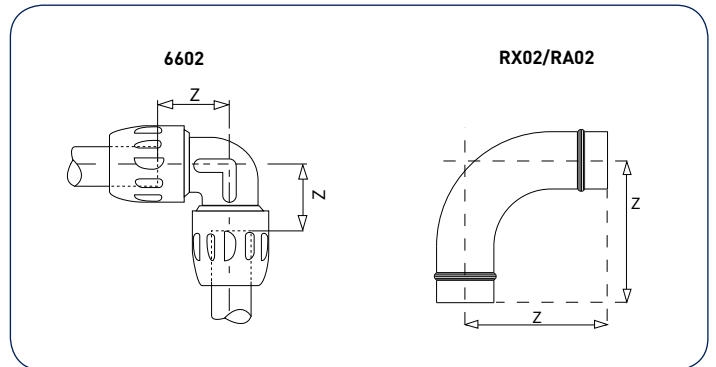
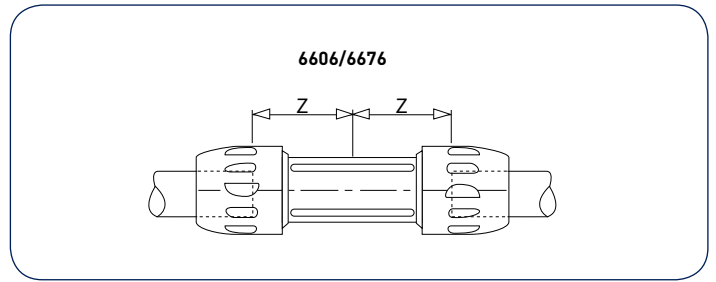

RA69	Z (mm)
Ø 25 -> Ø 16.5	47
Ø 40 -> Ø 25	63
Ø 50 -> Ø 25	66
Ø 63 -> Ø 25	72

6662	Z (mm)
Ø 25 -> Ø 16.5	82
Ø 25 -> Ø 25	74
Ø 40 -> Ø 16.5	89
Ø 40 -> Ø 25	82
Ø 50 -> Ø 25	58
Ø 63 -> Ø 25	65

RX04/RA04	Z1 (mm)	Z2 (mm)
Ø 76	146	146
Ø 100	156	136
Ø 168	180	185
Ø 100 -> Ø 76	156	136
Ø 168 -> Ø 76	180	185
Ø 168 -> Ø 100	180	185

RX24/RA04 + 6606	Z1 (mm)	Z2 (mm)
Ø 76 -> Ø 40	146	219
Ø 76 -> Ø 50	146	210
Ø 76 -> Ø 63	146	213
Ø 100 -> Ø 40	156	232
Ø 100 -> Ø 50	156	223
Ø 100 -> Ø 63	156	226
Ø 168 -> Ø 63	180	220

6666	Z (mm)	RX64/RA66	Z (mm)
Ø 25 -> Ø 16.5	51	Ø 76 -> Ø 50	270
Ø 40 -> Ø 25	71	Ø 76 -> Ø 63	280
Ø 50 -> Ø 25	70	Ø 100 -> Ø 50	393
Ø 50 -> Ø 40	66	Ø 100 -> Ø 63	300
Ø 63 -> Ø 40	75	Ø 100 -> Ø 76	193
Ø 63 -> Ø 50	65	Ø 168 -> Ø 76	210
		Ø 168 -> Ø 100	210

6651	Z (mm)
Ø 25	107
Ø 40	61

6652	Z (mm)
Ø 25	204
Ø 40	217

6609	Z1 (mm)	Z2 (mm)
Ø 16.5 -> 1/4	31	41
Ø 16.5 -> 1/2	31	46
Ø 25 -> 1/2	40	53
Ø 25 -> 3/4	40	53
Ø 25 -> 1"	40	55
Ø 40 -> 1"	62	75
Ø 40 -> 1"1/4	62	81
Ø 40 -> 1"1/2	62	81
Ø 40 -> 2"	62	81
Ø 50 -> 1"1/2	56	97
Ø 50 -> 2"	56	99
Ø 63 -> 2"	61	105
Ø 63 -> 2"1/2	61	104

6619	Z1 (mm)	Z2 (mm)
Ø 16.5 -> 1/4	32	42
Ø 16.5 -> 1/2"	32	42
Ø 25 -> 1/2"	32	44
Ø 25 -> 3/4	45	58
Ø 25 -> 1"	45	64
Ø 40 -> 1"	45	64
Ø 40 -> 1"1/4	45	64
Ø 40 -> 1"1/2	38	80
Ø 40 -> 2"	38	82
Ø 50 -> 1"1/2	37	81
Ø 50 -> 2"	37	82

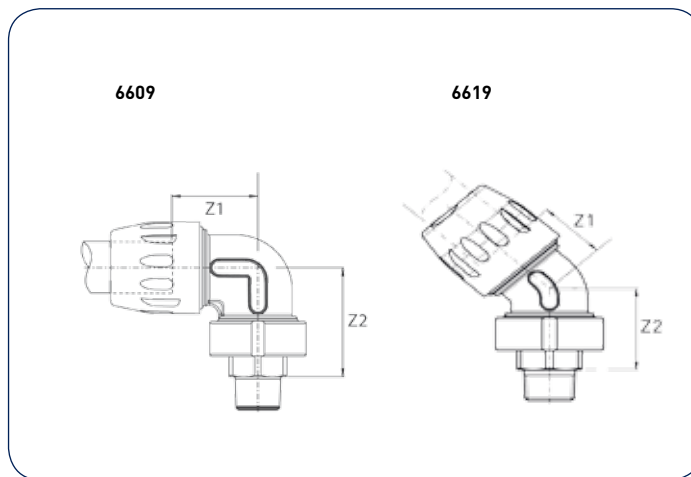
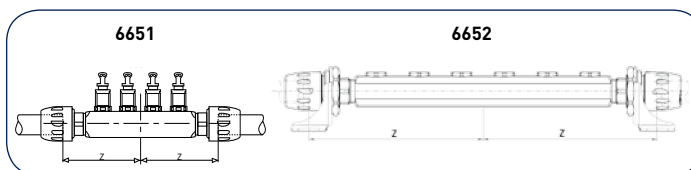
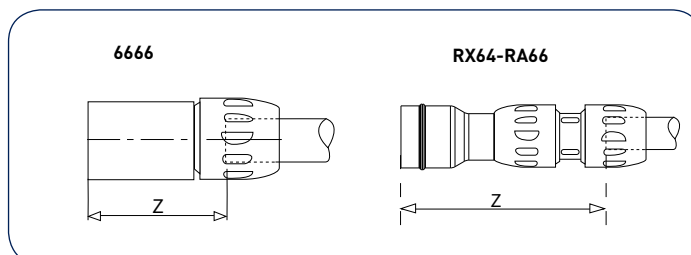
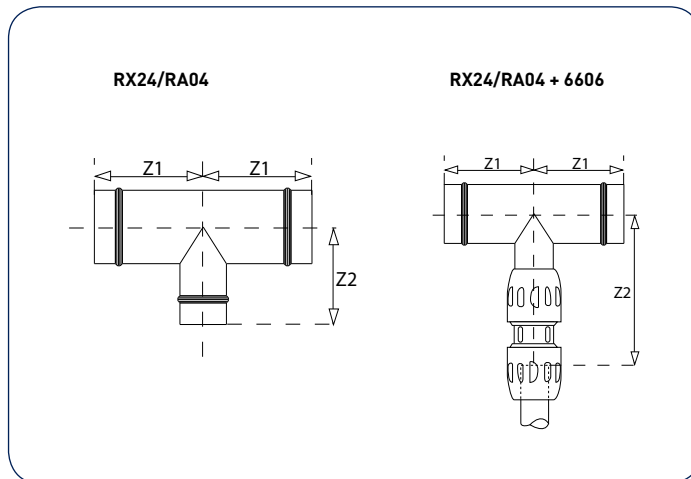
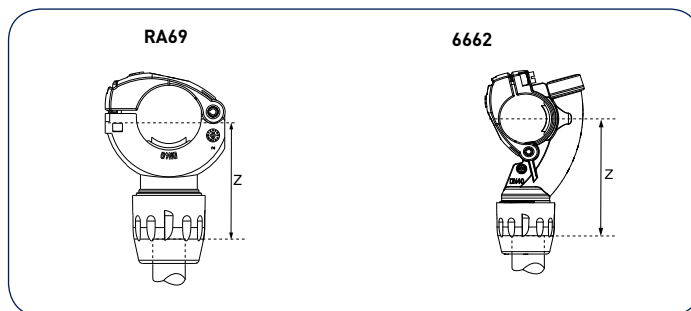

# PRACTICAL INFORMATION

## Z Dimensions

RA26	Z1 (mm)	Z2 (mm)	Z3 (mm)
Ø 63	280	252	280
Ø 76	260	106	260
Ø 100	280	116	280
Ø 100 -> Ø 76	280	116	280
Ø 168	350	126	350
Ø 168 -> Ø 100	330	86	306

RA26 + 6606	Z1 (mm)	Z2 (mm)	Z3 (mm)
Ø 76 -> Ø 40	344	106	260
Ø 76 -> Ø 50	330	106	260
Ø 76 -> Ø 63	330	106	260
Ø 100 -> Ø 63	330	116	280

RA07 + 6606	Z (mm)
Ø 40	240
Ø 50	228
Ø 63	232

RA07	Z (mm)
Ø 76	149
Ø 100	161
Ø 168	191

RA07 ... 45	Z1 (mm)	Z2 (mm)
Ø 76 -> DN80	207	149
Ø 100 -> DN100	219	161
Ø 168 -> DN150	258	191

RA44 ... 45	Z1 (mm)	Z2 (mm)
Ø 76 -> DN80	207	149
Ø 100 -> DN100	219	161
Ø 168 -> DN150	258	191

4092	Z1 (mm)	Z2 (mm)
Ø 16,5	29	43
Ø 25	41	57
Ø 40	56	58
Ø 50	43	60
Ø 63	66	77

VR02	Z (mm)
Ø 76	100
Ø 100	103
Ø 168	128

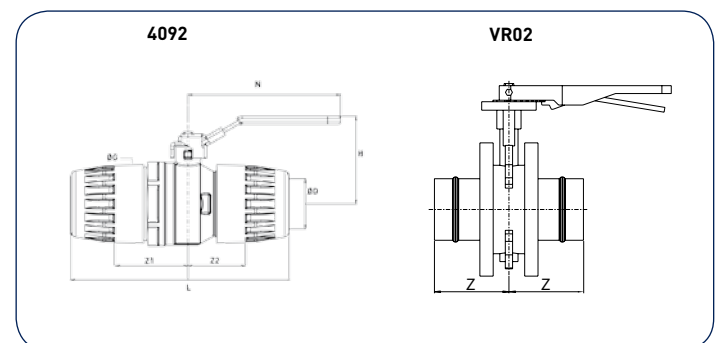
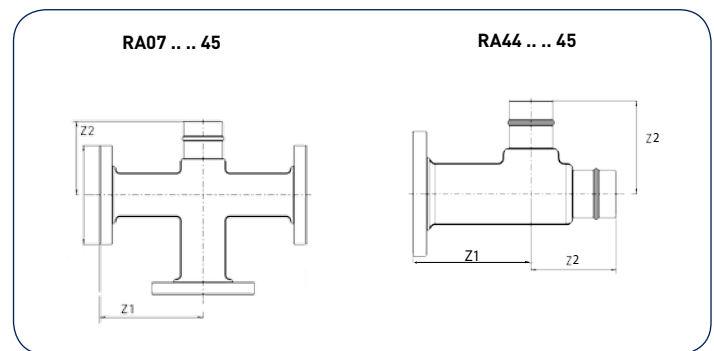
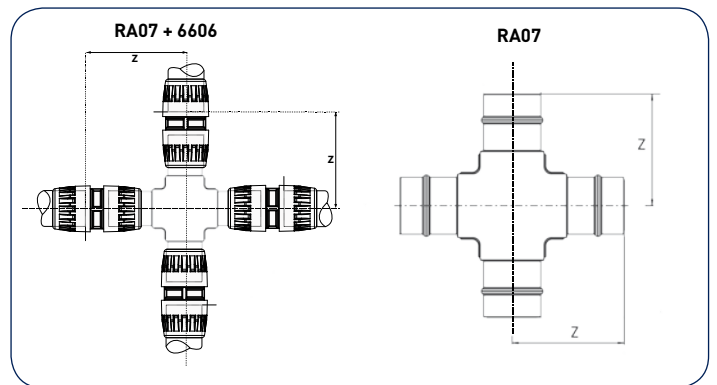
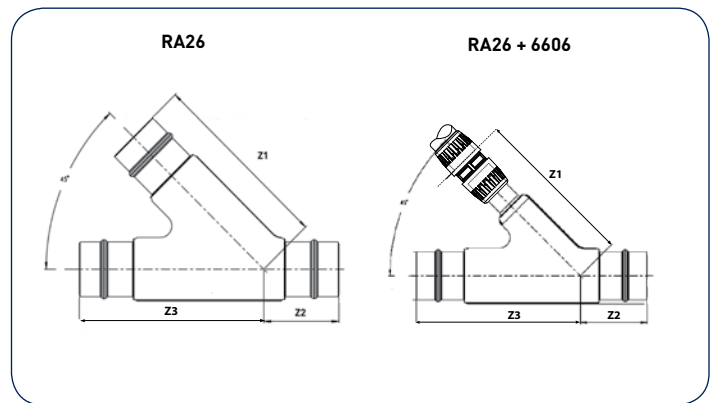

# Expansion / Contraction

In order to compensate for the effects of expansion and contraction due to variations in temperature, any fluctuations in the length of the Transair® aluminium pipe network should be calculated.

## EXPANSION CALCULATION

L: length of Transair® straight line to be installed (in m)  
 $\Delta T$ : variation between temperature when installing and maximum operating temperature (in C°)

$\Delta L$ : line length variation (in mm)

For Transair® Ø16.5 - Ø25 - Ø40 - Ø50 - Ø63 - Ø76 - Ø100 aluminium pipe networks:

$$\Delta L = \frac{(a \times L)}{1} + \frac{(0.024 \times L \times \Delta T)}{2}$$

1 - Expansion related to pipe retraction in the connector

2 - Expansion related to temperature variations

	Ø16.5	Ø25	Ø40	Ø50	Ø63	Ø76	Ø100	Ø168
<b>Pipe 3m</b>	a=0.06	a=0.20	a=0.40	a=0.68	a=0.68	a=1.0	a=1.0	a=1.34
<b>Pipe 6m</b> (4.5m for Ø16.5)	a=0.045	a=0.10	a=0.20	a=0.34	a=0.34	a=0.50	a=0.50	a=0.67

## DIRECTION CHANGE

- For Transair® aluminium pipe networks  
Ø16.5 - Ø25 - Ø40 - Ø50 - Ø63

$$\Delta L1 = H \times 20$$

H in m,  $\Delta L1$  in mm

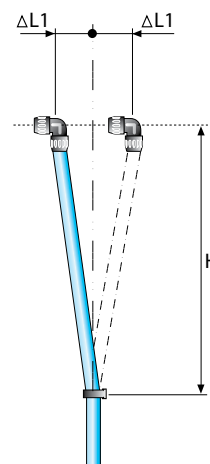

## USING AN ELBOW

- For Transair® aluminium pipe networks  
Ø76 - Ø100

$$\Delta L1 = H \times 13.33$$

## USING A QUICK ASSEMBLY BRACKET

- For Transair® aluminium pipe networks  
Ø16.5 - Ø25 - Ø40 - Ø50 - Ø63

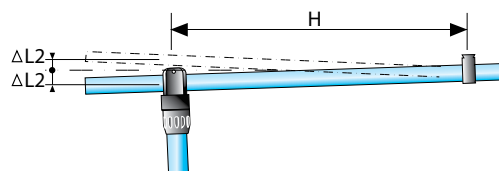

$$\Delta L2 = H \times 8.67$$

$$\Delta L3 = H \times 8.67$$

H in m,  $\Delta L2$  and  $\Delta L3$  in mm

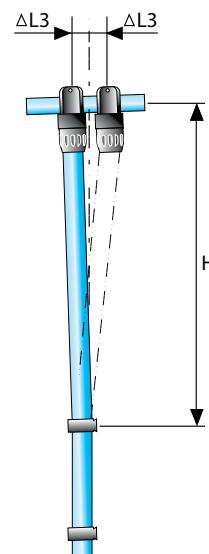

# PRACTICAL INFORMATION

## Expansion / Contraction

- For Transair® aluminium pipe networks  
Ø76 - Ø100

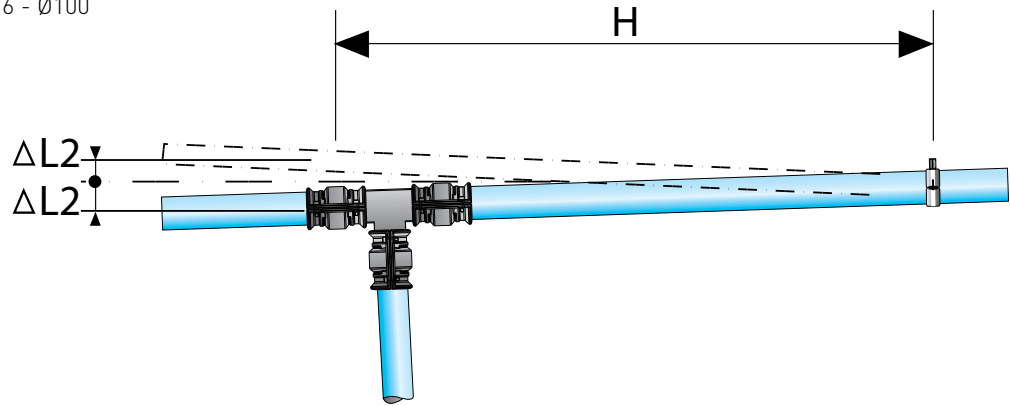

### CHANGING DIRECTION WITH A TEE PIECE

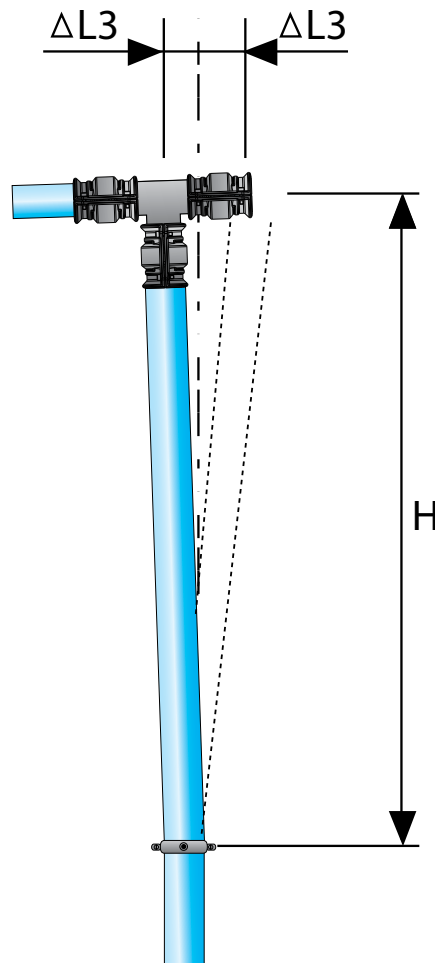

$$\Delta L2 = H \times 6.67$$
$$\Delta L3 = H \times 6.67$$

H in m,  $\Delta L2$  and  $\Delta L3$  in mm

- Maximum compensation:  
 $\varnothing 16.5$  mm to  $\varnothing 63$  mm:

$$\Delta L \text{ (in mm)} = H \text{ (in m)} \times 40$$

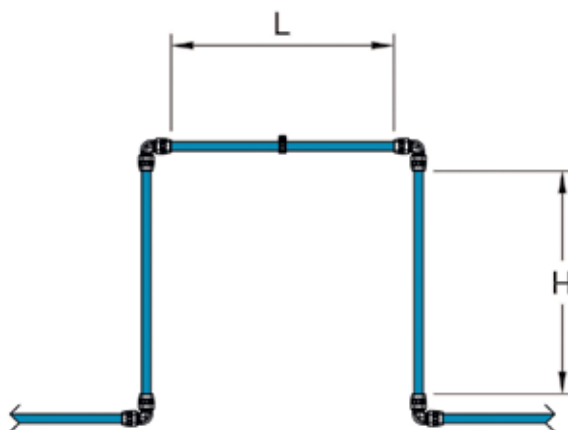

**EXPANSION LOOP**

$\varnothing 76$  mm to  $\varnothing 168$  mm

$$\Delta L \text{ (in mm)} = H \text{ (in m)} \times 27$$

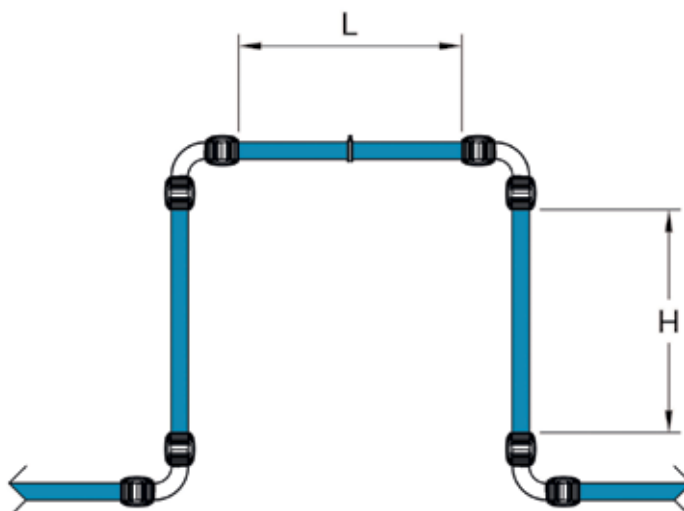

# BENDING TRANSAIR® ALUMINIUM PIPE

## All Diameters

Thanks to their technical characteristics, Transair® aluminium pipe can be bended according to the following specifications:

Transair®	R min. (mm)	L min. (mm)
Ø 16.5	102	185
Ø 25	154	185
Ø 40	250	185
Ø 50	300	185
Ø 63	394	185
Ø 76	317	185
Ø 100	423	185
Ø 168	700	185

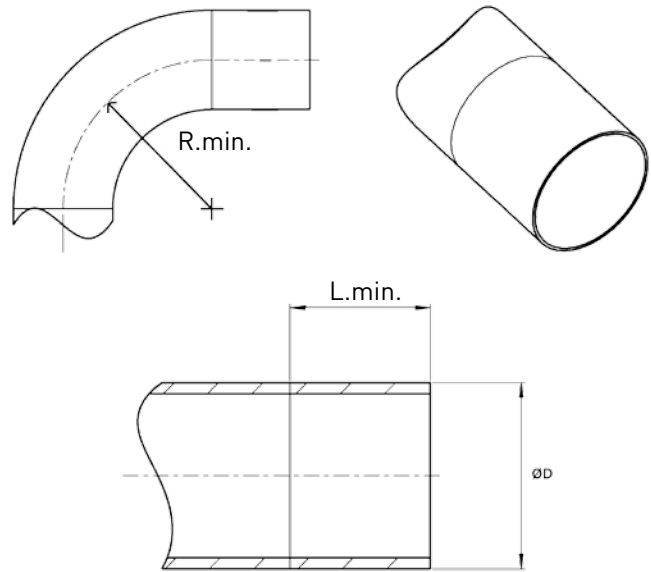

# TESTING A NETWORK

## Final Commissioning

### Transair® Advice for Final Commissioning of a Compressed Air Network

#### Example - considering a system working at 6 bar pressure

1. Run compressor at 3bar pressure to check integrity of the Transair® system and that the compressors are running correctly.
2. Leave the pipework under pressure for a period of 12 hours overnight. During this period the Transair® system should be isolated from machines and tools (drop valves should be closed).
3. Upon checking of the system after the 12 hour period, the compressor read can show a 0.3 bar pressure loss (from 3 bar to 2.7bar with constant temperature).
4. The system pressure is increased to design pressure (6 bar in this example) for a further 4 hours again (with no leak recorded from the Transair® system).
5. The system is then increased to 9 bar (1.43 x the max operating pressure) for a period of 1 hour with no further issues (NB: for this test, pressure of the system can exceed the maximum working pressure).
6. Purge the system, and you can start to work.

### Legal Requirement for Installers according to PED 97/23/EU - ANNEX I Essential Safety Requirements

#### 3.2. 3.2. Final Assessment:

Pressure equipment must be subject to final assessment as described below.

##### 3.2.1. Final Inspection:

Pressure equipment must undergo a final inspection to assess visually and by examination of the accompanying documents compliance with the requirements of the Directive. Test carried out during manufacture may be taken into account.

##### 3.2.2. Proof Test:

Final assessment of pressure equipment must include a test for the pressure containment aspect, which will normally take the form of a hydrostatic pressure test at a pressure at least equal, where appropriate, at the maximum allowable pressure multiplied by the coefficient 1.43.

**For category I series-produced pressure equipment, this test may be performed on a statistical basis. For series-produced pressure equipment under the article 4.3, this test is not necessary..**

For the Transair® system, the category is defined according to the diameter and the working pressure:

	1 bar	7 bar	10 bar	13 bar	16 bar
Ø16.5	Article 4.3	Article 4.3	Article 4.3	Article 4.3	Article 4.3
Ø25	Article 4.3	Article 4.3	Article 4.3	Article 4.3	Article 4.3
Ø40	Article 4.3	Article 4.3	Article 4.3	Article 4.3	Article 4.3
Ø50	Article 4.3	Article 4.3	Article 4.3	Article 4.3	Article 4.3
Ø63	Article 4.3	Article 4.3	Article 4.3	Article 4.3	Article 4.3
Ø76	Article 4.3	Article 4.3	Article 4.3	Article 4.3	Catégorie I
Ø100	Article 4.3	Article 4.3	Article 4.3	Catégorie I	Catégorie I
Ø168	Article 4.3	Catégorie I	Catégorie I	Catégorie I	Catégorie I

### Requested Documentation for Category I Equipment

To comply with the PED here is a list of documents you should provide to the end user and how to get them for Transair®.

- **Assembly Guide:** for every diameter it is delivered with the Transair® pipes or fittings.
- **CE Certificate:** Transair® conforms the European Pressure Equipment Directive 2014/68/UE for article 4.3 and category I. Please contact Parker Transair for the latest version.
- **ISO 9001 Certificate:** this document has a validity date. Please contact Parker Transair for the latest version.

- **Material Certificate B3.1B for Pipes:** it attests the conformity of the aluminium used (according to NF EN 10204). Ask for this document when placing the order. If needed you can also request it after delivery with the batch number marked on the pipes (see example on this picture).

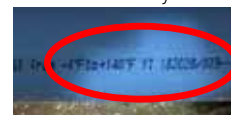

- **Material Certificate for Fittings:** the certificate 2.2 attests the quality checks completed during production (according to NF EN 10204). Ask for this document when placing the order, it can't be issued after as the name of the client and the order number have to be indicated on the certificate.

- **Isometric Plan of the System:** if needed, the Transair® quotation service can help you providing a drawing of the network (transair.quotation@parker.com).

- **Calculation Note:** Transair® aluminium pipes are produced according to EN 755-2, which defines the mechanical characteristics, and the TÜV certificate includes control of the design and of the safety factors. For further information, please contact Parker Transair.



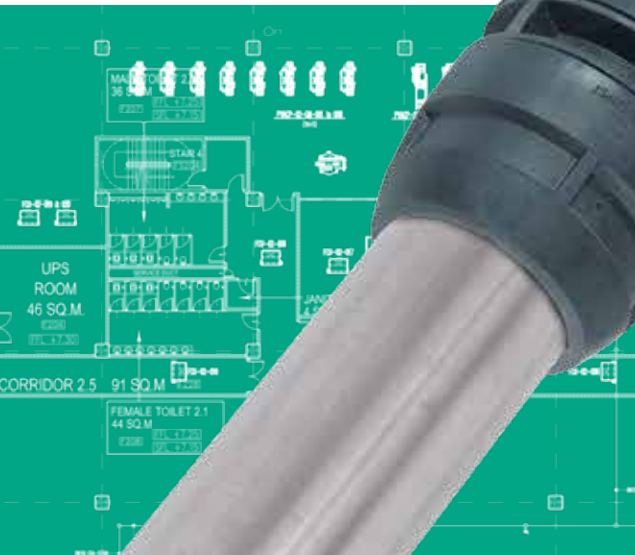



# TRANSAIR® STAINLESS STEEL RANGE

FOR INDUSTRIAL WATER AND OIL,  
COMPRESSED AIR, VACUUM  
AND INERT GAS

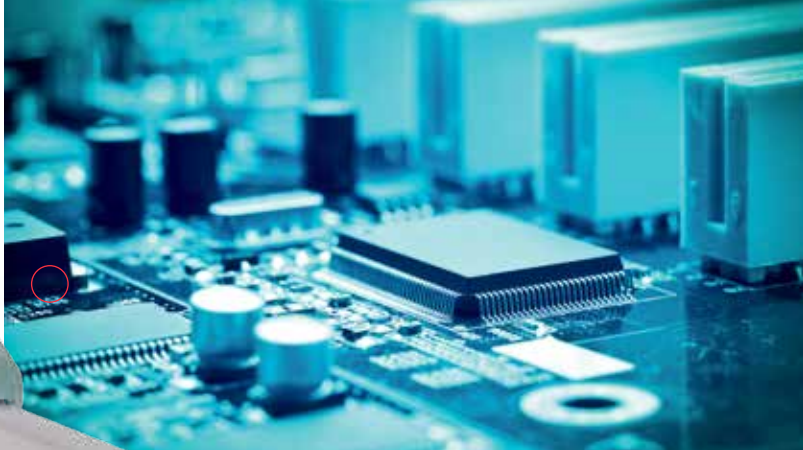

<b>Technical Information</b>	<b>114 to 119</b>
Technical Specifications	114
Chemical Compatibility	115
Sizing a Network	116
Transair® Standards and Certifications	117
Material Stainless Steel Range	118
Transair® Connection Technologies	119

<b>Product Range</b>	<b>121 to 133</b>
Stainless Steel Pipe	122
Pipe-to-Pipe & Stud Connectors	124
Quick Assembly Bracket and Wall Brackets	129
Ball Valves & Butterfly Valves	130
Tools	132
Fixtures & Accessories	133

<b>Installation Guide</b>	<b>135 to 151</b>
The Golden Rules of Installation	136
Stainless Steel Pipe	138
Transair® Connectors	142
Practical Examples	146
Attachment and Support	147
Fitting a Bracket	148
Bending a Stainless Steel Pipe	149
Practical Information	150

<b>Stainless Steel Drops</b>	<b>152 - 153</b>
<b>Parker Products from the Technical Room to the Heart of Production</b>	<b>154</b>
<b>Index</b>	<b>158</b>

# TECHNICAL SPECIFICATIONS

## Fluids

- Industrial water
- System compatible with additives (glycol or inhibitors) which prevent the formation of algae or fungus (list available upon request)
- Lubricating oils
- Compressed air (dry, wet, lubricated)
- Vacuum
- Inert gases (argon, nitrogen)
- Others: please consult us

## Maximum Working Pressure According to the Temperature

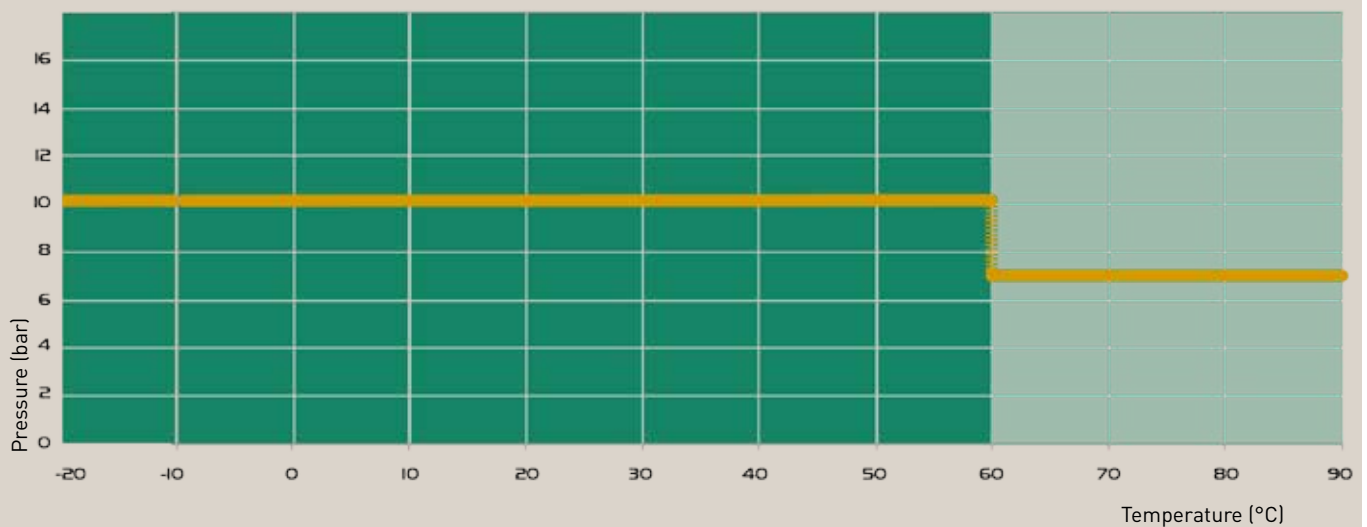

## Working Pressure

- 10 bar from -20°C to +60°C
- 7 bar from -20°C to +90°C

## Expansion Coefficient

- Expansion coefficient of Transair® stainless steel pipe: 0.016 mm per metre per degree celcius

## Resistance

- to corrosion
- to aggressive environments
- to mechanical shocks
- to thermal variations
- to U.V.

## Environment and Sustainable Development

Transair® materials are 100 % recyclable.

## Water Hammer

- Ø22, Ø28: comply with standard BS, 7291 part 1
- Ø42, Ø60, Ø76, Ø100: comply with standard NF T54-091

# CHEMICAL COMPATIBILITY

**1 Compatible**
**2 Compatible (except for diameters 22-28 mm in bronze)**
**3 Do not use**

CHEMICAL PRODUCT	SYMBOL	SEAL SELECTION		CHEMICAL PRODUCT	SYMBOL	SEAL SELECTION	
		EPDM	FKM			EPDM	FKM
• Acetaldehyde, Aldehyd acid	C2H4O	2	3	• Methanol, methyl alcohol (MKB, MEK, MIBK)		1	3
• Acetic acid (10%, 20°C)	CH3COOH	2	3	• Methyl Alcohol	CH4O	1	3
• Acetic acid (50%, 20°C)	CH3COOH	3	3	• Mineral oil		3	1
• Acetone, Propan-2-one, Dimethyl cetone	C3H6O	1	3	• Motor oil		3	1
• Air (dry)		1	1	• MPG, mono propylen glycol	C3H8O2	2	2
• Air (lubricated)		3	1	• Naphta		3	1
• Ammonia liquid	NH3 + H2O	2	3	• Nitric acid	HNO3	3	3
• Ammonium hydroxide	NH4OH	3	3	• Nitrogen (gas)	N	1	1
• Ammonium nitrate		2	2	• Oil ASTM n°1		3	1
• Ammonium phosphate		3	2	• Oil ASTM n°2		3	1
• Argon (gas)	Ar	1	1	• Oil ASTM n°3		3	1
• Boric acid (23°C)	H3BO3	1	1	• Oxalique acid (10%, 23°C)	HOO-COOH	2	2
• Brine	NaCl + H2O	2	2	• Oxygen (>20%)	O	3	3
• Calcium hydroxide, Slaked lime	Ca(OH)2	1	1	• Ozone	O	2	2
• Carbolic acid		3	3	• Perchloric acid (70%)		3	3
• Carbon monoxide (60°C)	CO	1	1	• Phosphate ester hydraulic fluid, Skydrol		1	3
• Carbon dioxide (dry)	CO2	1	1	• Phosphoric acid, Orthophosphoric acid	H3PO4	2	2
• Carbon dioxide (wet or 60°C)	CO2	3	2	• Potassium hydroxide (50%, 85°C)	KOH	2	3
• Carbon sulfite		3	2	• Sea water	H2O, NaCl	2	2
• Chlorine (sea chlorinated fluid)		3	3	• Silicon emulsions		1	1
• Citric acid (50%)	C6H8O7	2	2	• Sodium bicarbonate, baking soda (23°C)		1	1
• Diacetone alcohol	C6H12O2	1	3	• Sodium carbonate		1	1
• Ethane-diol, monoethylene glycol, MEG	C2H6O2	2	2	• Sodium hydroxide, caustic soda (50%)	NAOH	2	3
• Ethylene glycol	C2H4 (OH)2	1	1	• Sodium nitrite		2	2
• Formic acid, methanoic acid	CH2O2	3	3	• Sodium peroxide	Na2O2	3	3
• Gallic acid (5%)	C7H6O5	1	1	• Sodium phosphate	NA3PO4	2	2
• Glycol		1	1	• Sodium sulphate	Na2SO4	1	1
• Glycolic acid (50%)		3	3	• Aqueous solution of detergent		2	2
• Helium (gas)	He	1	1	• Sulfuric acid (10%, 20°C)	H2SO4	3	3
• Hydraulic fluid - mineral oil	-	3	1	• Tartric acid (50%, 23°C)		3	2
• Hydraulic fluid - petroleum based	-	3	1	• Trichlorethylene, Trichloride ethylene	C2HCl3	3	3
• Hydraulic fluid - silicone based	-	1	1	• Triethanolamine, TEA	C6H15O3N	2	3
• Hydrofluoridric acid	HF	3	3	• Water demineralised	H2	2	2
• Hydrogen bromide (20%)	HBr	3	3	• Water drinkable	H2O	3	3
• Hydrogen peroxide (30%)	H2O2	3	1	• Water industrial	H2	1	1
• Hydrogen sulfide	H2S	3	3	• Water with chlorine (5%, 23°C)	H2O, Cl, NaOCl	3	3
• Hydrolchloric acid (3%), Hydrogen chloride	HCl	3	3				

This information is given for information only.

For further information and specific conditions of use, please contact our technical department.

# IZING A NETWORK

Select the Transair® diameter for your application, based on required flow against pressure drop.

Estimated values for a closed loop network, a pressure of 4 bar with less than 10% pressure drop.  
Velocity: 4 m/s.

Estimated Flow Rate				Equivalent Length									
				32.8 ft	65.6 ft	98.4 ft	131.2 ft	164 ft	246 ft	328 ft	492 ft	656 ft	984 ft
m³/h	l/s	l/min	cfm	10 m	20 m	30 m	40 m	50 m	75 m	100 m	150 m	200 m	300 m
0.5	0.14	8	0.3	22	22	22	22	22	22	22	22	22	28
1	0.28	17	0.6	22*	22*	22*	22*	22*	28	28	28	28	42
2.5	0.69	42	1.5	22*	28*	28*	28*	42	42	42	42	42	42
3.5	0.97	58	2.1	28	28	42	42	42	42	42	42	42	60
5	1.39	83	3	28*	42*	42*	42*	42*	42*	42*	60	60	60
10	2.77	167	6	42*	42*	42*	60*	60*	60*	60*	60*	76	76
15	4.17	250	9	42*	60*	60*	60*	60*	60*	76	76	76	76
20	5.56	333	12	60*	60*	60*	60*	60*	76*	76*	76*	100	100
30	8.33	500	18	60*	60*	76*	76*	76*	76*	100*	100*	100*	100*
40	11.11	667	24	76*	76*	76*	76*	76*	100*	100*	100*	100*	
50	13.89	833	29	76*	76*	76*	100*	100*	100*	100*			
75	20.83	1250	44	100*	100*	100*	100*	100*					
80	22.22	1333	47	100*	100*	100*	100*	100*					
100	27.78	1667	59	100*	100*	100*	100*						

\* These results should be taken into account in order to ensure the best practice for industrial water networks.  
An anti-water hammer device is necessary for the protection of regulation components of other fragile elements.

## Example (with the above values)

- Main network length (main ring): 50 metres
- Required flow rate: 15 m³/h
- Working pressure: 4 bar
- Pressure drop < 10 %
- Velocity: 4m/s
- The most suitable Transair® diameter is: Ø60.

## DIN 1988

The pressure drop per diameter is stated for a flow rate and a velocity, at a temperature of 20°C.  
Technical data sheet available upon request.

# I TRANSAIR® STANDARDS AND CERTIFICATIONS

Transair® stainless steel range certifications fall within the standard and regulation universe described on pages 8 and 9 of this catalogue.

## Standards Related to Transair® Stainless Steel Pipe

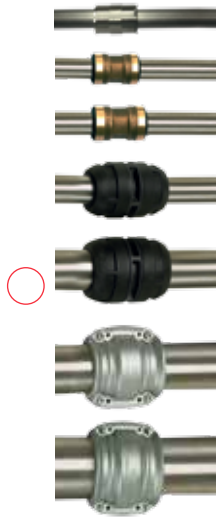

I Transair® stainless steel range conforms to the standards below related to mechanical and chemical properties per diameter.

	Ø 22 - Ø 28	Ø 42 - Ø 60	Ø 76 - Ø 100
<b>Manufacturing Standards</b>	EN 10217-7	EN 10217-7	EN 10217-7
<b>Grade</b>	EN 10088-2, 4404, AISI 316L	1.4301 / AISI 304	1.4301 / AISI 304
<b>Welding Standard</b>	DIN 17 457, EN 10217-7	DIN 17 457, EN 10217-7	DIN 17 457, EN 10217-7
<b>Tolerances</b>	DVGW - W541	EN 1127D4/T3	EN 1127D4/T3

The quality and consistency of the stainless steel grade used allow to bend Transair® stainless steel pipe according to the best practice, as described in page 149 of this catalogue.

## Applications



### I FDA Certificate – CFR 21

Transair® stainless steel drops diameter 22mm presented on pages 152 and 153 of this catalogue conform to FDA – CFR 21 requirements.

## Safety



### I UL94 Certificate

All Transair® components are non-flammable with no propagation of flame.

Pipe-to-pipe connectors, ball valves and butterfly valves conform to UL94HB standards.

The above mentioned certificates are available upon request.

# MATERIAL STAINLESS STEEL RANGE

	Ø22 - Ø28	Ø42 - Ø60	Ø76 - Ø100
<b>PIPE</b>	316L Stainless Steel	304 Stainless Steel	304 Stainless Steel
<b>CONNECTOR</b>	Body: bronze Gripping Ring: stainless steel Retaining cap: HR Polymer	Body: HR Polymer Nut: HR Polymer Clamp: HR Polymer	Clamp: treated steel Cartridge: HR Polymer and stainless steel
<b>90° ELBOW</b>	Body: bronze Gripping Ring: stainless steel Retaining cap: HR Polymer	Body:HR Polymer Nut: HR Polymer	304 Stainless Steel
<b>45° ELBOW</b>	-	304 Stainless Steel	304 Stainless Steel
<b>180° ELBOW</b>	-	304 Stainless Steel	-
<b>TEE</b>	Body: bronze Gripping Ring: stainless steel Retaining cap: HR Polymer	Body:HR Polymer Nut: HR Polymer	304 Stainless Steel
<b>REDUCING TEE</b>	Body:bronze Gripping Ring: stainless steel Retaining cap: HR Polymer	-	304 Stainless Steel
<b>IN-LINE REDUCER</b>	Body: bronze Gripping Ring: stainless steel Retaining cap: HR Polymer	Treated Brass	304 Stainless Steel
<b>END-CAP</b>	Body: bronze Gripping Ring: stainless steel Retaining cap: HR Polymer	304 Stainless Steel	304 Stainless Steel
<b>MALE STUD FITTING</b>	Body: bronze Gripping Ring: stainless steel Retaining cap: HR Polymer	-	-
<b>MALE ADAPTOR</b>	-	Treated Brass	Treated Brass
<b>WALL BRACKET</b>	Treated Brass	-	-
<b>BUTTERFLY VALVE</b>	-	Body: iron / Handle: aluminium	Body and handle: iron Disc and shaft: stainless steel /Handle: aluminium
<b>QUICK ASSEMBLY BRACKET</b>	-	Iron and treated steel	Iron and treated steel
<b>FLANGE</b>	-	304 Stainless Steel	304 Stainless Steel
<b>BALL VALVE</b>	Body: nickel-plated brass Seal: PTFE		
<b>FIXING CLIP</b>	304 Stainless Steel		
<b>NON SLIP CLIP</b>	Collar: zinc-plated steel    Lining: elastomer		
<b>THREADED ROD</b>	Steel		
<b>SCREW TYPE BEAM CLAMP</b>	Formed Steel		

All seals are available in EPDM or FKM (unless otherwise stated).

# TRANSAIR® CONNECTION TECHNOLOGIES

Transair® innovative technology takes into account the specific requirements of each diameter and provides the user with an optimum safety coefficient and easy connection.

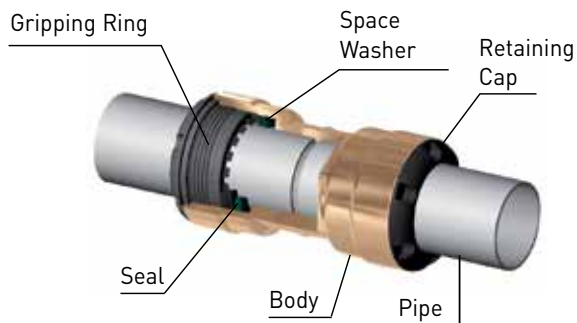

## Ø22 - Ø28mm

Pipe-to-pipe and stud connectors in Ø22 and Ø28 can be immediately connected to Transair® stainless steel -pipe – simply push the pipe into the connector up to the connection mark. The gripping ring of each fitting is then automatically secured and the connection is safe.

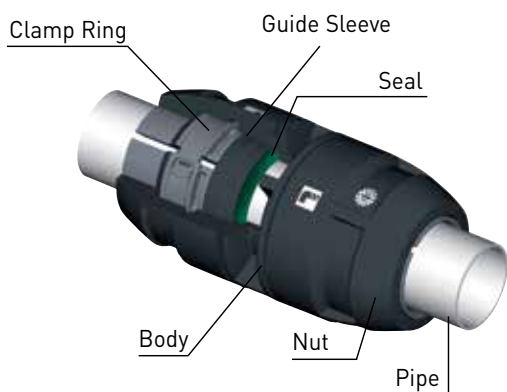

## Ø42 - Ø60mm

Pipe-to-pipe and stud connectors in Ø42 and Ø60 can be quickly connected to Transair® stainless steel pipe by means of a double clamp ring. This secures the connection between the nut and the pipe – tightening of the nuts secures the final assembly.

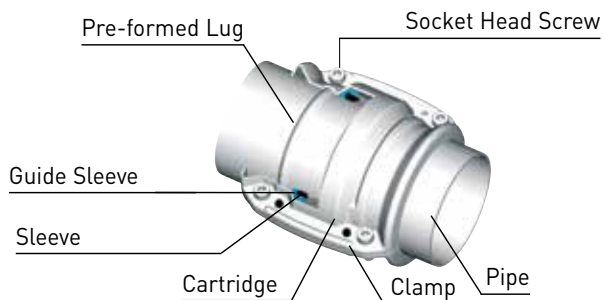

## Ø76 - Ø100mm

Pipe-to-pipe and stud connectors in Ø76 and Ø100 can be quickly connected to Transair® stainless steel pipe. Position the pipes to be connected within the Transair® cartridge and close/tighten the Transair® clamp.





# TRANSAIR® STAINLESS STEEL RANGE

PRODUCT RANGE

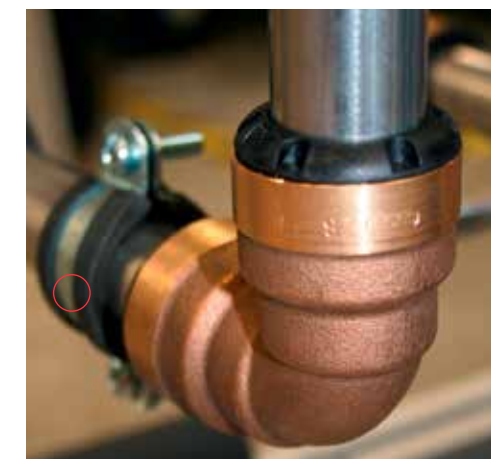

**Stainless Steel Pipe**



122

**Pipe-To-Pipe & Stud Connectors**



124

**Quick Assembly Brackets and Wall Brackets**



129

**Ball Valves and Butterfly Valves**



130

**Tools**



132

**Fixtures and Accessories**



133

# STAINLESS STEEL PIPE

Ø  
22  
28

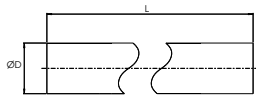

## STAINLESS STEEL PIPE AISI 316L

Transair®	ØD	ext. Ø	int. Ø	L(m)	Kg
TF03 N7 00	22	22	19.6	3	1.860
TF06 N7 00	22	22	19.6	6	3.720
TF03 N9 00	28	28	25.6	3	2.430
TF06 N9 00	28	28	25.6	6	4.860

Ø  
42  
60

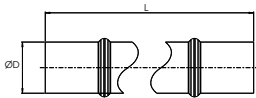

## STAINLESS STEEL PIPE AISI 304

Transair®	ØD	ext. Ø	int. Ø	L(m)	Kg
TX03 M4 00	42	42.3	39.1	3	4.902
TX06 M4 00	42	42.3	39.1	6	9.804
TX03 M6 00	60	60.3	57.1	3	7.053
TX06 M6 00	60	60.3	57.1	6	14.106

Ø  
76  
100

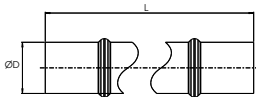

## STAINLESS STEEL PIPE AISI 304

Transair®	ØD	ext. Ø	int. Ø	L(m)	Kg
TX03 L1 00	76	76.1	72.9	3	8.955
TX06 L1 00	76	76.1	72.9	6	17.910
TX03 L3 00	100	101.6	97.6	3	14.964
TX06 L3 00	100	101.6	97.6	6	29.928

Please consult the installation guide on page 138 of this catalogue for pipe installation.

## STANDARDS

	Ø 22 - Ø 28	Ø 42 - Ø 60	Ø 76 - Ø 100
<b>Manufacturing Standards</b>	EN 10217-7	EN 10217-7	EN 10217-7
<b>Grade</b>	EN 10088-2, 1.4404 / AISI 316 L	1.4301 / AISI 304	1.4301 / AISI 304
<b>Welding Standards</b>	DIN 17 457, EN 10217-7	DIN 17 457, EN 10217-7	DIN 17 457, EN 10217-7
<b>Tolerances</b>	DVGW - W541	EN 1127 D4 / T3	EN 1127 D4 / T3

## VOLUME AND MASS

Ø ext (mm)	Ø int (mm)	Value for 1 metre of pipe		
		Volume (l)	Pipe mass (kg)	Mass of the network full of water (kg)
22.0	19.6	0.30	0.627	0.929
28.0	25.6	0.51	0.808	1.323
42.3	39.1	1.20	1.616	2.817
60.3	57.1	2.56	2.331	4.892
76.1	72.9	4.17	2.958	7.132
101.6	97.6	7.48	4.944	12.425

## FIXTURES AND ACCESSORIES

Ø  
22  
↓  
100



### FIXING CLIP

Transair®	ØD	C
ER01 N7 00	22	M8 / M10
ER01 N9 00	28	M8 / M10
ER01 M4 00	42	M8 / M10
ER01 M6 00	60	M8 / M10
ER01 L1 00	76	M8 / M10
ER01 L3 00	100	M8 / M10

Maximum admitted static load: 210 daN

Ø  
42  
60  
76  
100

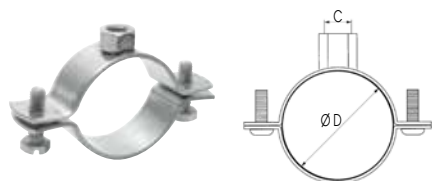

### NON SLIP STAINLESS STEEL CLIP

Transair®	ØD	C
EX01 M4 00	42	M8 / M10
EX01 M6 00	60	M8 / M10
EX01 L1 00	76	M8 / M10
EX01 L3 00	100	M8 / M10

Maximum admitted static load: 200 daN

# PIPE-TO-PIPE AND STUD CONNECTORS

The range of Transair® pipe-to-pipe and stud connectors provides versatility of design.

- ▮ Quick connection
- ▮ Dismountable and reusable
- ▮ Full bore design (consistent inner diameter for both pipe and connectors)

Ø  
22  
28

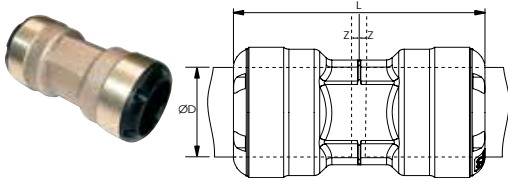

## PIPE-TO-PIPE CONNECTOR

Transair®	Seal	ØD	L	Z	Kg
RR06 N7 01	EPDM	22	63.2	1.2	0.125
RR06 N9 01	EPDM	28	85.5	1.2	0.245
RR06 N7 02	FKM	22	63.2	1.2	0.125
RR06 N9 02	FKM	28	85.5	1.2	0.245

Ø  
42  
60

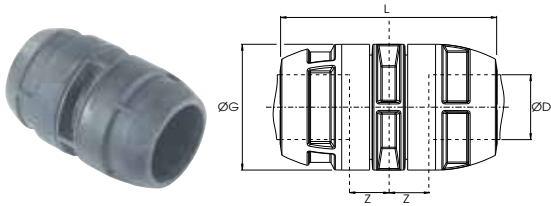

Transair®	Seal	ØD	ØG	L	Z	Kg
RP06 M4 01	EPDM	42	82	155	2.6	0.493
RP06 M6 01	EPDM	60	100	156	2.6	0.656
RP06 M4 02	FKM	42	82	155	2.6	0.493
RP06 M6 02	FKM	60	100	156	2.6	0.656

Ø  
76  
100

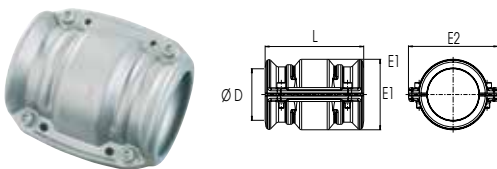

## CONNECTOR (CLAMP + CARTRIDGE)

Transair®	Seal	ØD	L	E1	E2	M	N	Kg
RR01 L1 01	EPDM	76	146	104	132	88.7	51.4	1.131
RR01 L3 01	EPDM	100	146	128	157	125	52.7	1.480
RR01 L1 02	FKM	76	146	104	132	88.7	51.4	1.131
RR01 L3 02	FKM	100	146	128	157	125	52.7	1.480

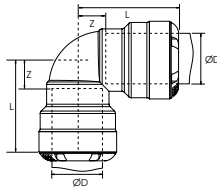
Ø 22 28			<b>90° ELBOW</b>					
			<b>Transair®</b>		<b>ØD</b>	<b>L</b>	<b>Z</b>	<b>Kg</b>
			<b>RR02 N7 01</b>	<b>EPDM</b>	22	43.6	13.2	0.160
			<b>RR02 N9 01</b>	<b>EPDM</b>	28	56	14.5	0.266
			<b>RR02 N7 02</b>	<b>FKM</b>	22	43.6	13.2	0.160
		<b>RR02 N9 02</b>	<b>FKM</b>	28	56	14.5	0.266	

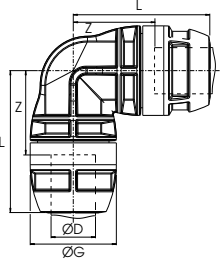
Ø 42 60									
			<b>Transair®</b>		<b>ØD</b>	<b>ØG</b>	<b>L</b>	<b>Z</b>	<b>Kg</b>
			<b>RP02 M4 01</b>	<b>EPDM</b>	42	82	130	55	0.599
			<b>RP02 M6 01</b>	<b>EPDM</b>	60	100	139	64	0.825
			<b>RP02 M4 02</b>	<b>FKM</b>	42	82	130	55	0.599
		<b>RP02 M6 02</b>	<b>FKM</b>	60	100	139	64	0.825	

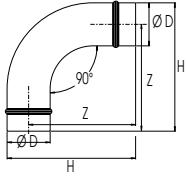
Ø 76 100							
			<b>Transair®</b>	<b>ØD</b>	<b>H</b>	<b>Z</b>	<b>Kg</b>
			<b>RX02 L1 00</b>	76	227	189	1.033
		<b>RX02 L3 00</b>	100	278	227	1.417	

Use 2 connectors RR01 to connect elbow RX02 to Transair® stainless steel pipe.

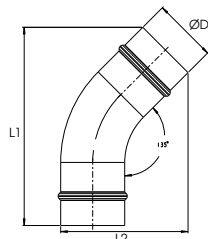
Ø 42 60			<b>45° ELBOW</b>				
			<b>Transair®</b>	<b>ØD</b>	<b>L1</b>	<b>L2</b>	<b>Kg</b>
			<b>RX12 M4 00</b>	42	288	149	0.481
			<b>RX12 M6 00</b>	60	300	167	0.527

Use 2 connectors RP06 to connect elbow RX12 to Transair® stainless steel pipe.

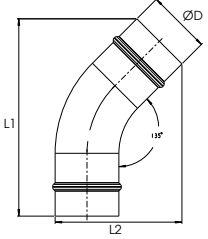
Ø 76 100							
			<b>Transair®</b>	<b>ØD</b>	<b>L1</b>	<b>L2</b>	<b>Kg</b>
			<b>RX12 L1 00</b>	76	235.5	151.4	0.704
			<b>RX12 L3 00</b>	100	271.4	184.3	1.309

Use 2 connectors RR01 to connect elbow RX12 to Transair® stainless steel pipe.

# PIPE-TO-PIPE AND STUD CONNECTORS

Ø  
22  
28

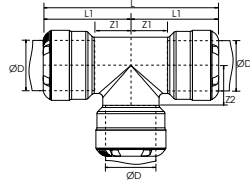

## EQUAL TEE

Transair®	Seal	ØD	L	L1	Z1	Z2	Kg
RR04 N7 01	EPDM	22	42.1	43.6	11.7	11	0.210
RR04 N9 01	EPDM	28	56	56	14.5	14.5	0.389
RR04 N7 02	FKM	22	42.1	43.6	11.7	11	0.210
RR04 N9 02	FKM	28	56	56	14.5	14.5	0.389

Ø  
42  
60

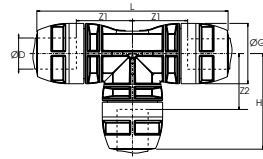

Transair®	Seal	ØD	ØG	L	H	Z1	Z2	Kg
RP04 M4 01	EPDM	42	82	260	130	55	55	0.894
RP04 M6 01	EPDM	60	100	279	139	64	64	1.200
RP04 M4 02	FKM	42	82	260	130	55	55	0.894
RP04 M6 02	FKM	60	100	279	139	64	64	1.200

Ø  
76  
100

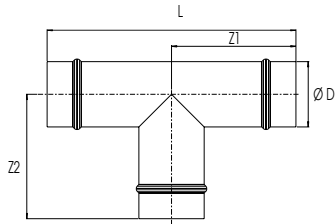

Transair®	ØD	L	Z1	Z2	Kg
RX04 L1 00	76	292	145	145	1.063
RX04 L3 00	100	312	155	135	1.787

Use 3 connectors RR01 to connect equal tee RX04 to Transair® stainless steel pipe Ø76 or Ø100.

Ø  
22  
28

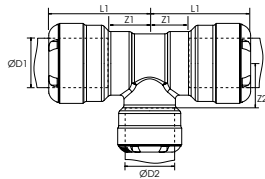

## REDUCING TEE

Transair®	Seal	ØD1	ØD2	L1	Z1	Z2	Kg
RR04 N9 N7 01	EPDM	28	22	47	12	16	0.326
RR04 N9 N7 02	FKM	28	22	47	12	16	0.326

Ø  
76  
100

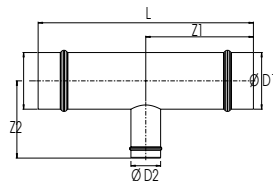

Transair®	ØD1	ØD2	L	Z1	Z2	Kg
RX04 L1 M4	76	42	290	145	183	1.029
RX04 L1 M6	76	60	290	145	183	1.103
RX04 L3 M4	100	42	310	155	195	1.680
RX04 L3 M6	100	60	310	155	195	1.739
RX04 L3 L1	100	76	310	155	135	1.637

Use 2 connectors RR01 to connect reducing tee RX04 to Transair® stainless steel pipe Ø76 or Ø100 and 1 connector RP06 to connect to Transair® stainless steel pipe Ø42 or Ø60.

Ø  
22

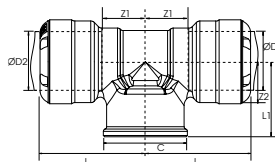

**THREADED TEE**

Transair®		ØD	C	L	L1	Z1	Z2	Kg
RR23 N7 06 01	EPDM	22	3/4"	42.1	30	11.7	13.7	0.189
RR23 N7 06 02	FKM	22	3/4"	42.1	30	11.7	13.7	0.189

Ø  
76  
100

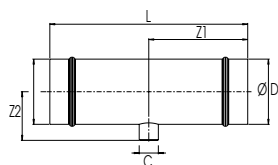

Transair®	ØD	C	L	Z1	Z2	Kg
RX23 L1 04	76	G1/2	292	145	63	0.892
RX23 L3 04	100	G1/2	312	155	75.8	1.564

Use 2 connectors RR01 to connect threaded tee RX23 to Transair® stainless steel pipe Ø76 or Ø100.

Ø  
42  
60

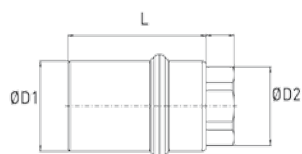

**PLUG-IN REDUCER**

Transair®	ØD1	ØD2	L	Kg
RR14 M4 06	42	G 3/4	88	0.600
RR14 M4 08	42	G 1	160	0.800
RR14 M6 06	60	G 3/4	92	1.000
RR14 M6 08	60	G 1	92	0.850

Use a connector RP06 to connect plug-in reducer RP14 to Transair® stainless steel pipe Ø42 or Ø60 and a connector RR05 to connect to Transair® stainless steel pipe Ø22 or Ø28.

Ø  
60  
76  
100

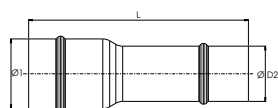

Transair®	ØD1	ØD2	L	Kg
RX66 M6 M4	60	42	220	0.376
RX66 L1 M6	76	60	240	0.549
RX66 L3 L1	100	76	192	0.702

Use a connector RR01 to connect plug-in reducer RX66 to Transair® stainless steel pipe Ø76 or Ø100 and a connector RP06 to connect to Transair® stainless steel pipe Ø60.



# PIPE-TO-PIPE AND STUD CONNECTORS

Ø  
22  
28

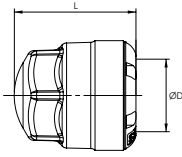

## END CAP

Transair®	Seal	ØD	L	Kg
RR25 N7 01	EPDM	22	41.1	0.081
RR25 N9 01	EPDM	28	54.5	0.146
RR25 N7 02	FKM	22	41.1	0.081
RR25 N9 02	FKM	28	54.5	0.146

Ø  
42  
60

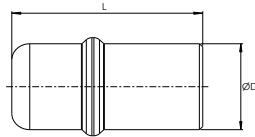

Transair®	ØD	L	Kg
RR25 M4 00	42	85	0.465
RR25 M6 00	60	85	0.718

Ø  
76  
100

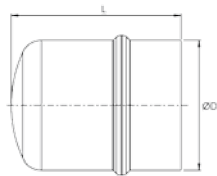

Transair®	ØD	L	Kg
RX25 L1 00	76	106	0.346
RX25 L3 00	100	107.4	0.539

Use 1 connector RR01 to connect end cap RX25 to Transair® stainless steel pipe Ø76 or Ø100.

Ø  
22  
28

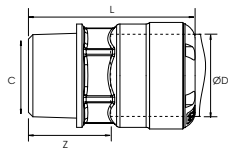

## MALE STUD FITTING, BSP TAPER

Transair®	Seal	ØD	C	L	Z	Kg
RR05 N7 04 01	EPDM	22	1/2	51.1	20.7	0.100
RR05 N7 06 01	EPDM	22	3/4	52.6	22.2	0.104
RR05 N9 08 01	EPDM	28	1"	65.5	22.1	0.181
RR05 N7 04 02	FKM	22	1/2	51.1	20.7	0.100
RR05 N7 06 02	FKM	22	3/4	52.6	22.2	0.104
RR05 N9 08 02	FKM	28	1"	65.5	22.1	0.181

Ø  
42  
60

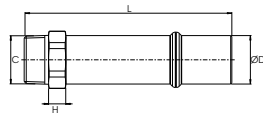

## MALE ADAPTOR, BSP TAPER

Transair®	ØD	C	L	H	Kg
RR05 M4 06	42	3/4	117	10	0.557
RR05 M4 10	42	1"1/4	183	15	0.896
RR05 M4 12	42	1"1/2	183	15	0.588
RR05 M6 06	60	3/4	117	10	1.005
RR05 M6 16	60	2"	192	15	1.787
RR05 M6 20	60	2"1/2	195	15	1.217

Use 1 connector RP06 to connect end cap RR05 to Transair® stainless steel pipe Ø42 or Ø60.

Ø  
76

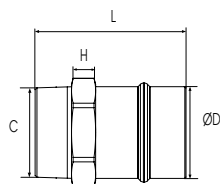

Transair®	ØD	C	L	H	Kg
RR05 L1 20	76	R2"1/2	125	20	1.968

Use 1 connector RR01 to connect end cap RR05 to Transair® stainless steel pipe Ø76.

# QUICK ASSEMBLY BRACKETS AND WALL BRACKETS

Ø  
42  
60  
76  
100

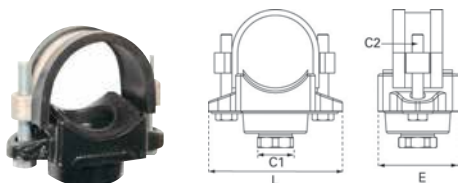

## QUICK ASSEMBLY DIRECT FEED BRACKET

Transair®	Seal	ØD	C1	C2	E	L	Kg
RR82 M4 06 01	EPDM	42	3/4	M10	49	88	0.445
RR82 M6 06 01	EPDM	60	3/4	M10	62	117	0.900
RR82 L1 08 01	EPDM	76	1"	M12	50	137	1.950
RR82 L3 08 01	EPDM	100	1"	M12	80	158	1.960
RR82 M4 06 02	FKM	42	3/4	M10	49	88	0.445
RR82 M6 06 02	FKM	60	3/4	M10	62	117	0.900
RR82 L1 08 02	FKM	76	1"	M12	50	137	1.950
RR82 L3 08 02	FKM	100	1"	M12	80	158	1.960

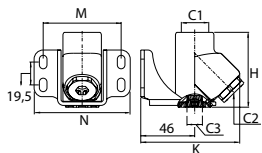

## 1 PORT 45° THREADED WALL BRACKET, BSP PARALLEL

Transair®	C1	C2	C3	H	K	M	N	Kg
6641 21 21	G1/2	G1/2	G1/4	64	84.5	66.5	82	0.539

Supplied with G1/2" plug

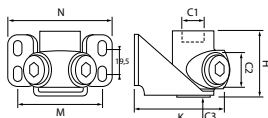

## 2 PORT 90° THREADED WALL BRACKET, BSP PARALLEL

Transair®	C1	C2	C3	H	K	M	N	Kg
6686 21 21	G1/2	G1/2	G1/4	48	72.5	66.5	82	0.415

Supplied with G1/2" plugs

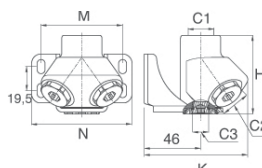

## 2 PORT 45° THREADED WALL BRACKET, BSP PARALLEL

Transair®	C1	C2	C3	H	K	M	N	Kg
6690 21 21	G1/2	G1/2	G1/4	64	84.5	66.5	82	0.672

Supplied with G1/2" plugs

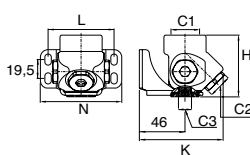

## 3 PORT THREADED WALL BRACKET, BSP PARALLEL

Transair®	C1	C2	C3	H	K	M	N	Kg
6635 27 21	G3/4	G1/2	G1/4	64	84.5	66.5	82	0.750

Supplied with G1/2" plugs

# BALL VALVES AND BUTTERFLY VALVES

Transair® ball valves and butterfly valves placed regularly throughout the network and at key locations allow ease of system isolation, adaptation and maintenance. These valves are silicone-free.

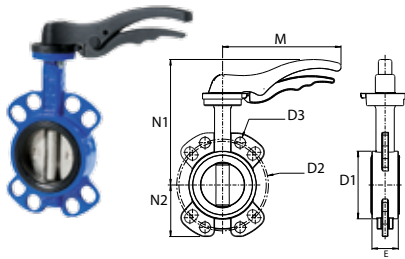

## BUTTERFLY VALVE

Transair®	Seal	ØD	DN	ØD1	ØD2	ØD3	M	N1	N2	E	Kg
VR02 M4 01	EPDM	42	32	73	100	18	192	178	56	33	1.700
VR02 M4 02	FKM	42	32	73	100	18	192	178	56	33	1.700
VR02 M6 01	EPDM	60	50	89	125	18	170	176	62	43	2.100
VR02 M6 02	FKM	60	50	89	125	18	170	176	62	43	2.100
VR02 L1 01	EPDM	76	80	118	160	18	206	219	90	46	3.200
VR02 L1 02	FKM	76	80	118	160	18	206	219	90	46	3.200
VR02 L3 01	EPDM	100	100	150	180	18	206	239	106	52	4.300
VR02 L3 02	FKM	100	100	150	180	18	206	239	106	52	4.300

Models with CE marking. NBR seal. EW06 bolt kits are not supplied for valve/flanges assembly. The butterfly valves do not require additional ring when connected to circular flanges. Suitable for flanges according to EN 1092-1 - PN 16.



## BOLT KIT FOR BUTTERFLY VALVE AND STAINLESS STEEL FLANGE

Transair®	C	L	Number of bolts	Kg
EW06 00 03	M16	90	x 8	1.820

## BOLT KITS FOR ASSEMBLY STAINLESS STEEL FLANGE / VALVE / STAINLESS STEEL FLANGE

Flange Part Numbers	Transair®	ØD	DN	Bolt Kit Part Number	Quantity of Bolt Kits	Max. Torque N.m
RX30 M4 00	VR02 M4 01	42	32	EW06 00 03	1 kit	50
RX30 M4 00	VR02 M4 02	42	32	EW06 00 03	1 kit	
RX30 M6 00	VR02 M6 01	60	50	EW06 00 03	1 kit	
RX30 M6 00	VR02 M6 02	60	50	EW06 00 03	1 kit	
RX30 L1 00 01	VR02 L1 01	76	80	EW06 00 03	1 kit	
RX30 L1 00 01	VR02 L1 02	76	80	EW06 00 03	1 kit	
RX30 L3 00	VR02 L3 01	100	100	EW06 00 03	1 kit	
RX30 L3 00	VR02 L3 02	100	100	EW06 00 03	1 kit	

## STAINLESS STEEL FLANGE (EN-ISO)

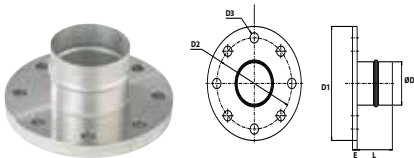

Transair®	ØD	DN	ØD1	ØD2	ØD3	E	L	Kg
RX30 M4 00	42	32	140	100	18	10	163	1.250
RX30 M6 00	60	50	165	125	18	10	141	1.700
RX30 L1 00	76	65	185	145	18	10	75	1.940
RX30 L1 00 01	76	80	200	160	18	10	75	2.250
RX30 L3 00	100	100	220	180	18	10	75	2.680

## EPDM GASKET FOR STAINLESS STEEL FLANGE

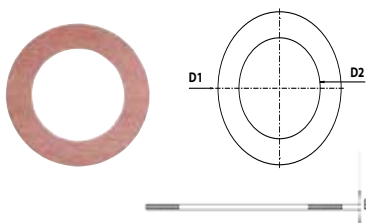

Transair®	DN	For Circular Flange	ØD1	ØD2	E	Kg
EW05 M4 01	32	RX30 M4 00	82	43	2	0.028
EW05 M6 01	50	RX30 M6 00	107	61	2	0.036
EW05 L1 01	65	RX30 L1 00	124	73	3	0.028
EW05 L1 00 01	80	RX30 L1 00 01	142	89	3	0.033
EW05 L3 01	100	RX30 L3 00	162	115	3	0.035

Ø  
42  
60  
76  
100

Ø  
42  
60  
76  
100

Ø  
42  
60  
76  
100



**BOLT KIT FOR STAINLESS STEEL FLANGE**

Transair®	C	L	Number of Bolts	Kg
EW06 00 01	M16	60	x 8	1.257

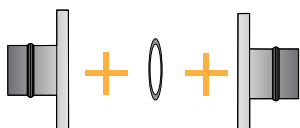

**GASKET AND BOLT KITS FOR ASSEMBLY STAINLESS STEEL FLANGE / STAINLESS STEEL FLANGE**

Transair®	ØD	DN	Part Number EPDM Gasket	PN Bolt Kit	Qty of Bolt Kit	Max. Tightening Torque N.m
RX30 M4 00	42	32	EW05 M4 01	EW06 00 01	1 kit	200
RX30 M6 00	60	50	EW05 M6 01	EW06 00 01	1 kit	
RX30 L1 00	76	65	EW05 L1 01	EW06 00 01	1 kit	
RX30 L1 00 01	76	80	EW05 L100 01	EW06 00 01	1 kit	
RX30 L3 00	100	100	EW05 L3 01	EW06 00 01	1 kit	

**BALL VALVE - DOUBLE FEMALE NICKEL-PLATED**

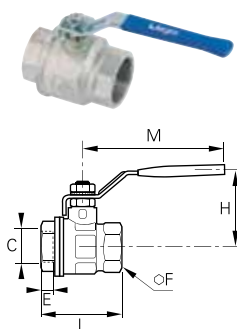

Transair®	C	DN	Max.P (bar)	E	F	H	L	M	Kg
VR03 00 02	G1/4	10	30	11.4	20	43	51.5	98	0.157
VR03 00 03	G3/8	10	30	11.4	20	43	51.5	98	0.141
VR03 00 04	G1/2	15	30	13.5	25	47	55	98	0.204
VR03 00 06	G3/4	20	30	12.5	31	58	57.5	122	0.310
VR03 00 08	G1"	25	30	15	38	60	69.5	122	0.460
VR03 00 10*	G1"1/4	32	30	17	48	77	81.5	153	0.751
VR03 00 12*	G1"1/2	40	30	18	54	83	95	153	1.100
VR03 00 16*	G2"	50	30	22	66	95	113	162	1.644
VR03 00 20*	G2"1/2	65	30	22	85	132	136	255	2.979

\*Model with CE marking.

**BALL VALVE - MALE / FEMALE - BSP MALE TAPER / FEMALE PARALLEL**

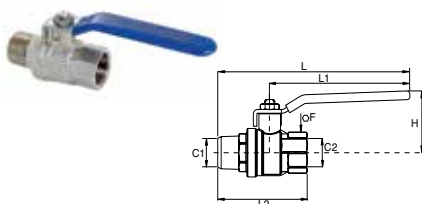

Transair®	C1	C	DN	Max.P (bar)	F	H	L	L1	L2	Kg
VR04 00 04	R1/2	G1/2	15	40	25	43	140.5	100	70.0	0.230
VR04 00 06	R3/4	G3/4	20	40	31	50	164.5	120	76.5	0.360
VR04 00 08	R1"	G1"	25	40	40	54	172	120	92.5	0.623
VR04 00 10*	R1"1/4	G1"1/4	32	40	49	73	217.5	158	106	0.965
VR04 00 12*	R1"1/2	G1"1/2	40	40	54	79	220	158	113	1.213
VR04 00 16*	R2"	G2"	50	40	68.5	86	230.5	158	133	1.983
VR04 00 20*	R2"1/2	G2"1/2	65	30	85	132	357.5	255	180.5	3.600

\*Model with CE marking.

# TOOLS

Ø  
42  
60  
76  
100



## PORTABLE TOOL KIT

Transair®	Voltage
EW01 00 01	220 V
EW01 00 03	110 V

This case contains : 1 portable tool, 1 14.4 V battery and battery charger.  
Additional battery: EW03 00 01

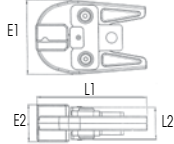

## JAW FOR PORTABLE TOOL

Transair®	ØD	E1	E2	L1	L2
EW02 M4 00	42	103	28	154	46
EW02 M6 00	60	103	42	154	46
EW02 L1 00	76	103	52	154	46
EW02 L3 00	100	103	71	154	46

Ø  
22  
↓  
100

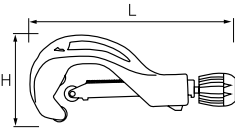

## CUTTER FOR STAINLESS STEEL PIPE

Transair®	L	H	Use for Transair® Pipe
6698 03 01	230	98	Ø 22 - 28 - 42 - 60 - 76
EW08 00 03	360	155	Ø 100

Spare rotary cutter blade for Transair® cutter 6698 03 01: EW08 00 99  
Spare rotary cutter blade for Transair® cutter EW08 00 03: EW08 00 04

Ø  
22  
28



## DISMOUNTING TOOL

EW11 00 01

Contains 1 key, 5 rings for dismantling Ø22 and 5 rings for dismantling Ø28

## MAINTENANCE SET

Transair®	Seal	ØD
EW10 N7 01	EPDM	22
EW10 N9 01	EPDM	28
EW10 N7 02	FKM	22
EW10 N9 02	FKM	28

Contains 5 complete fitting accessories

Ø  
42  
60



## SET OF TIGHTENING SPANNERS

6698 05 03

Ø  
42  
60  
76  
100

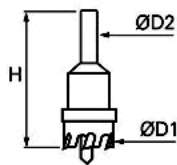

## DRILLING TOOL

Transair®	ØD1	ØD2	H	Kg	Use for Transair® Pipe
EW09 00 22	22	10	69	0.120	Ø 42 - 60
EW09 00 30	30	12	71	0.127	Ø 76 - 100

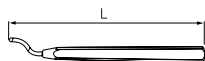
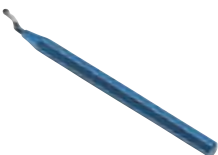

## DEBURRING TOOL

Transair®	L	Kg
6698 04 02	140	0.026

# FIXTURES AND ACCESSORIES



## THREADED ROD KIT

Transair®	C
ER99 05 02	M8
ER99 05 03	M10

Contains 10 threaded rods 1 metre length, 50 nuts and 10 threaded connectors.



## SCREW TYPE BEAM CLAMP

Transair®	For Screw
ER99 06 02	M8
ER99 06 03	M10

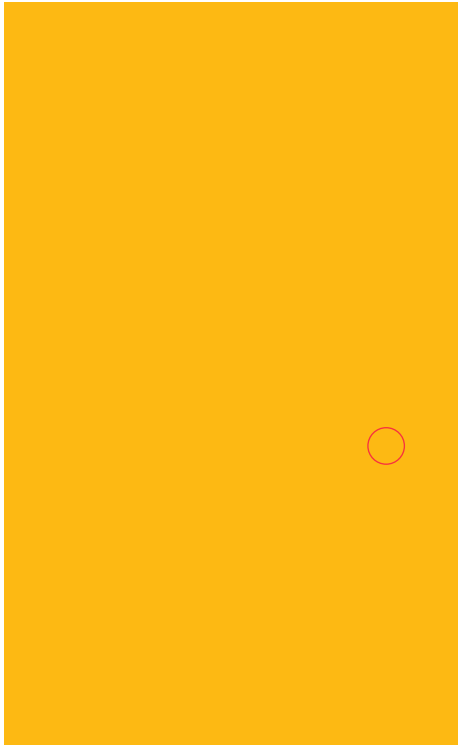

# TRANSAIR® STAINLESS STEEL RANGE

## INSTALLATION GUIDE

### The Golden Rules of Installation 136 to 137

Installation Instructions	136
Best Practices	137

### Transair® Stainless Steel Pipe 138 to 141

General	138
Pipe Section	139

### Transair® Connectors 142 to 146

General	142
Connection / Disconnection	143
Practical Examples	146
Attachment and Support	147

### Transair® Quick Assembly Brackets 148

Fitting a Bracket	148
-------------------	-----

### Bending a Transair® Stainless Steel Pipe 149

### Z Dimensions 150 - 151





# THE GOLDEN RULES OF INSTALLATION

## Installation Instructions

### I General

When maintaining or modifying a Transair® system, the relevant section should be purged prior to the commencement of any work.

Installers should only use Transair® components and accessories, in particular Transair® pipe clips and fixture clamps. The technical properties of the Transair® components, as described in the Transair® catalogue, must be respected.

### I Commissioning the Installation

Once the Transair® system has been installed and prior to commissioning, the installer should complete all tests, inspections and compliance checks as stated in any contract and according to sound engineering practice and current local regulations.

### I Transair® Pipe and Hoses

Transair® pipe should be protected from mechanical impact, particularly if exposed to potential collision with fork-lift trucks or when sited in an environment with moving overhead loads. Similarly, rotation of the pipe and pipe supports should be avoided. Transair® pipe must not be welded.

NB: For bending a Transair® stainless steel pipe, please refer to page 149 of this catalogue.

### I Component Assembly

Transair® components are provided with assembly instructions for their correct use - simply follow the methods and recommendations stated in this document or separate data sheets.

### I Transair® Installations - Prohibited Situations

- Installation within a solid mass (concrete, foam, etc.), especially underground
- The suspension of any external equipment from Transair® pipe
- The use of Transair® for earthing, or as a support for electrical equipment
- Exposure to chemicals that are incompatible with Transair® components [please contact us for further details].
- Use of components not approved by Transair®

## Best Practices

**| When installing a Transair® system, work should be performed in accordance with good engineering practice.**

**| Bends and bypasses represent sources of pressure drops.**

**| Keep in-line pipe diameter reductions to a minimum.**

**| The diameter of the pipe will influence pressure drop and the operation of point-of-use equipment.**

**| Select the diameter according to the required flow rate and acceptable pressure drop at the point of use.**

**| Never encase the network in a hard solid mass, in order to facilitate maintenance or servicing.**

**| To insulate Transair® industrial water systems thermally, we recommend insulating the Transair® stainless steel pipes.**

**| Position drops and feeds to take-off points as close as possible to the point of use.**

# TRANSAIR® STAINLESS STEEL PIPE

## General

### PRESENTATION

Transair® stainless steel pipe is supplied "ready for use". No particular preparation (cutting, deburring, chamfering, etc.) is required. Thanks to the rigidity of Transair® stainless steel pipe, temperature-related expansion / contraction phenomena are reduced to a minimum. The Transair® network retains its straightness, and hence its performance, over time (reduction of pressure drop caused by surface friction). Transair® stainless steel pipe is calibrated and fits perfectly onto all Transair® components. Each connection is automatically secured and sealing is, thus, optimized. The use of Transair® stainless steel pipe minimises corrosion.

Ø 22



DEBURRED AND  
CHAMFERED PIPE

Ø 28



DEBURRED AND  
CHAMFERED PIPE

Ø 42



PIPE LUGGED AT EACH END  
DEBURRED  
AND CHAMFERED

Ø 60



PIPE LUGGED AT EACH END  
DEBURRED  
AND CHAMFERED

Ø 76



PIPE LUGGED AT EACH END  
DEBURRED  
AND CHAMFERED

Ø 100



PIPE LUGGED AT EACH END  
DEBURRED  
AND CHAMFERED

### STANDARDS

	Ø 22 - Ø 28	Ø 42 - Ø 60	Ø 76 - Ø 100
<b>Manufacturing Standards</b>	EN 10217-7	EN 10217-7	EN 10217-7
<b>Grade</b>	EN 10088-2, 1.4404 / AISI 316 L	1.4301 / AISI 304	1.4301 / AISI 304
<b>Welding Standards</b>	DIN 17 457, EN 10217-7	DIN 17 457, EN 10217-7	DIN 17 457, EN 10217-7
<b>Tolerances</b>	DVGW - W541	EN 1127 D4 / T3	EN 1127 D4 / T3

### VOLUME AND MASS

Ø ext (mm)	Ø int (mm)	Value for 1 metre of pipe		
		Volume (l)	Pipe Mass (kg)	Mass of the Network Full of Water(kg)
22.0	19.6	0.30	0.627	0.929
28.0	25.6	0.51	0.808	1.323
42.3	39.1	1.20	1.616	2.817
60.3	57.1	2.56	2.331	4.892
76.1	72.9	4.17	2.958	7.132
101.6	97.6	7.48	4.944	12.425

# Pipe Section

<p>Ø 22 Ø 28</p>				
<p><b>TOOLS</b></p>	 <p>PIPE-CUTTER 6698 03 01</p>	 <p>CHAMFERING TOOL 6698 04 01</p>	 <p>DEBURRING TOOL 6698 04 02</p>	 <p>MARKER PEN</p>

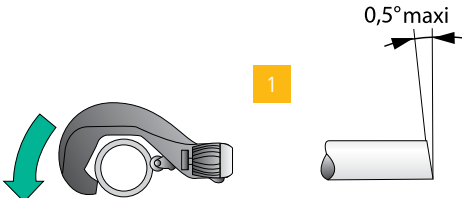
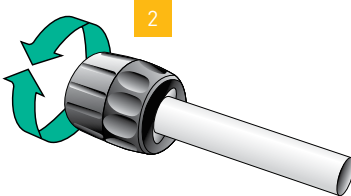
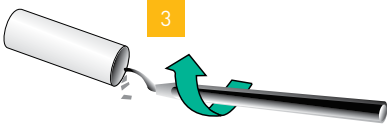
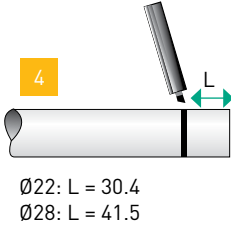
<p><b>PROCEDURE</b></p>	   			
	<p>1 - Cutting the pipe:          - place the pipe into the pipe cutter          - position the blade onto the pipe          - rotate the pipe cutter around the pipe while gently tightening the wheel.</p>		<p>2 - Carefully chamfer the outer edges          3 - Also deburr the interior end of the pipe          4 - Mark the connection indicator.</p>	

# TRANSAIR® STAINLESS STEEL PIPE

## Pipe Section

Ø 42 - Ø 60  
Ø 76 - Ø 100



PIPE-CUTTER

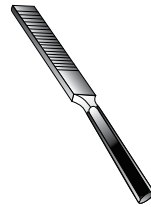

FILE



DEBURRING TOOL

### TOOLS



PORTABLE TOOL KIT REF.  
EW01 00 01 (220V) OR  
EW01 00 03 (110V)



PIPE FORMING JAW SET REF.  
EW02 M4 00 (Ø 42)  
EW02 M6 00 (Ø 60)  
EW02 L1 00 (Ø 76)  
EW02 L3 00 (Ø 100)

### 1 - PIPE SECTION

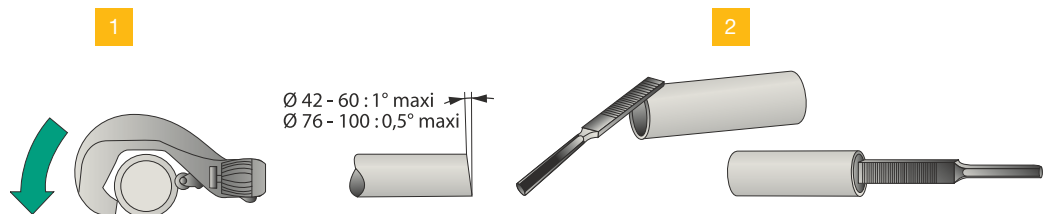

### PROCEDURE

- 1 - Cutting the pipe:
- place the pipe into the pipe cutter
  - position the blade onto the pipe
  - rotate the pipe cutter around the pipe while gently tightening the wheel

- 2 - Carefully chamfer and deburr the end of the pipe with a file.

## 2 - PREPARATION OF THE PORTABLE TOOL KIT



Open the retaining pin at the front of the machine by pressing the jaw to release button\*.



Place the jaws in the housing.



Lock in position by closing the retaining pin.

## 3 - HOW TO CREATE THE LUGS



Manually open the jaws of the clamp and insert the stainless steel pipe into the clamp as far as it will go.



Release the jaws. Press the trigger and crimp the tube until a 'snap' sound is heard.



Re-open the two jaws to remove the pipe and rotate the pipe slightly.



Renew the operation until the required minimum number of lugs for each diameter is achieved

### PROCEDURE

	Ø 42	Ø 60	Ø 76	Ø 100
Min. Number of Lugs	 4	 4	 6	 7

**IMPORTANT: DO NOT OVERLAP THE LUGS!**

# TRANSAIR® CONNECTORS

## General

### INSTANT CONNECTION BY MEANS OF A GRIPPING RING

Ø 22  
Ø 28

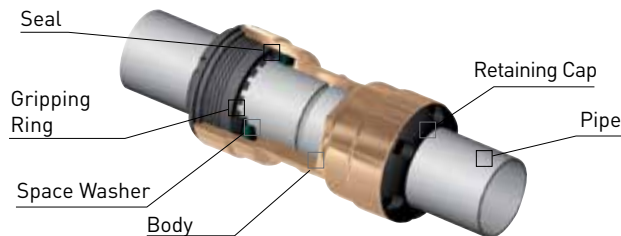

Pipe-to-pipe and stud connectors in Ø22 and Ø28 can be immediately connected to Transair® stainless steel pipe – simply push the pipe into

the connector up to the connection mark. The gripping ring of each fitting is then automatically secured and the connection is safe.

### DOUBLE-CLAMP QUICK-FIT CONNECTION

Ø 42  
Ø 60



Pipe-to-pipe and stud connectors in Ø42 and Ø60 can be quickly connected to Transair® stainless steel pipe by means of a double clamp ring. This

secures the connection between the nut and the pipe – tightening of the nuts secures the final assembly.

### CLAMP QUICK-FIT CONNECTION

Ø 76  
Ø 100

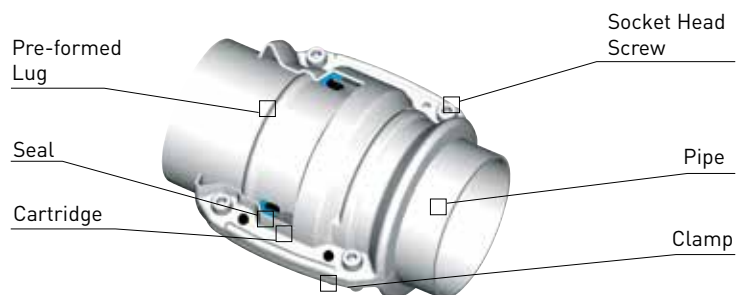

Pipe-to-pipe and stud connectors in Ø76 and Ø100 can be quickly connected to Transair® stainless steel pipe.

Position the pipes to be connected within the Transair® cartridge and close/tighten the Transair® clamp.

# Connection / Disconnection

Ø 22-28

TOOLS



DISMOUNTING TOOL  
EW11 00 01

## CONNECTION

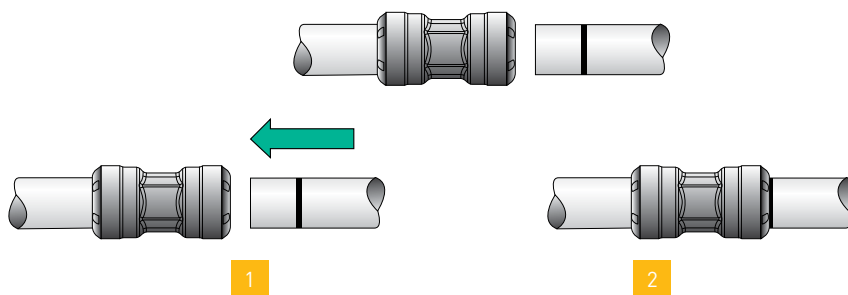

## DISCONNECTION

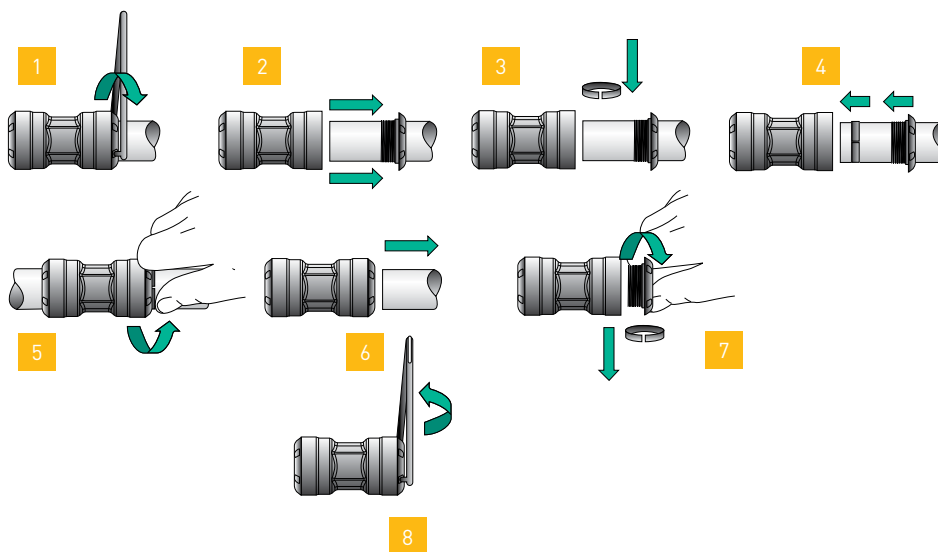

PROCEDURE



# TRANSAIR® CONNECTORS

Ø 42  
Ø 60

## CONNECTION / DISCONNECTION

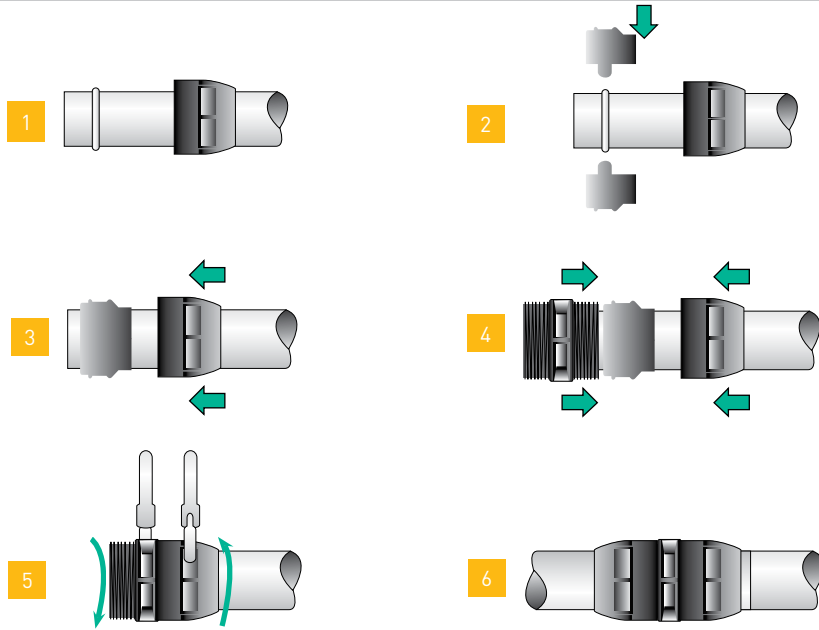

## LATERAL DISMOUNTING

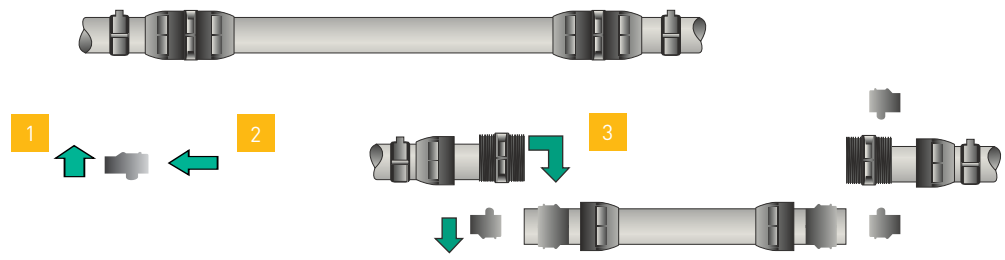

### REPLACE 1 CONNECTOR BY A TEE

Ø	L (mm)
42	105
60	123

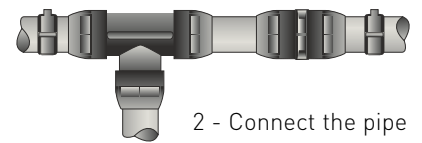
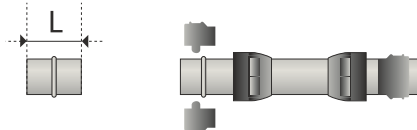

1 - Cut the pipe and create the lugs  
(cf pages 141)

2 - Connect the pipe



### ADD 1 TEE

Ø	L (mm)
42	110
60	128

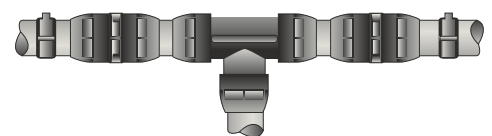
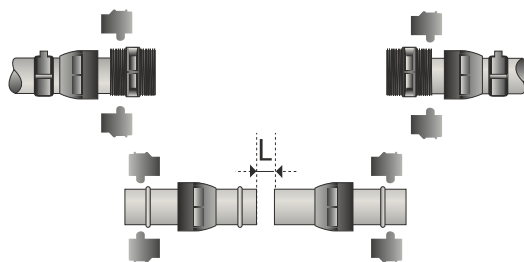

1 - Cut the pipe and create the lugs  
(cf pages 141)

2 - Connect the pipe

# Connection / Disconnection

Ø 76  
Ø 100

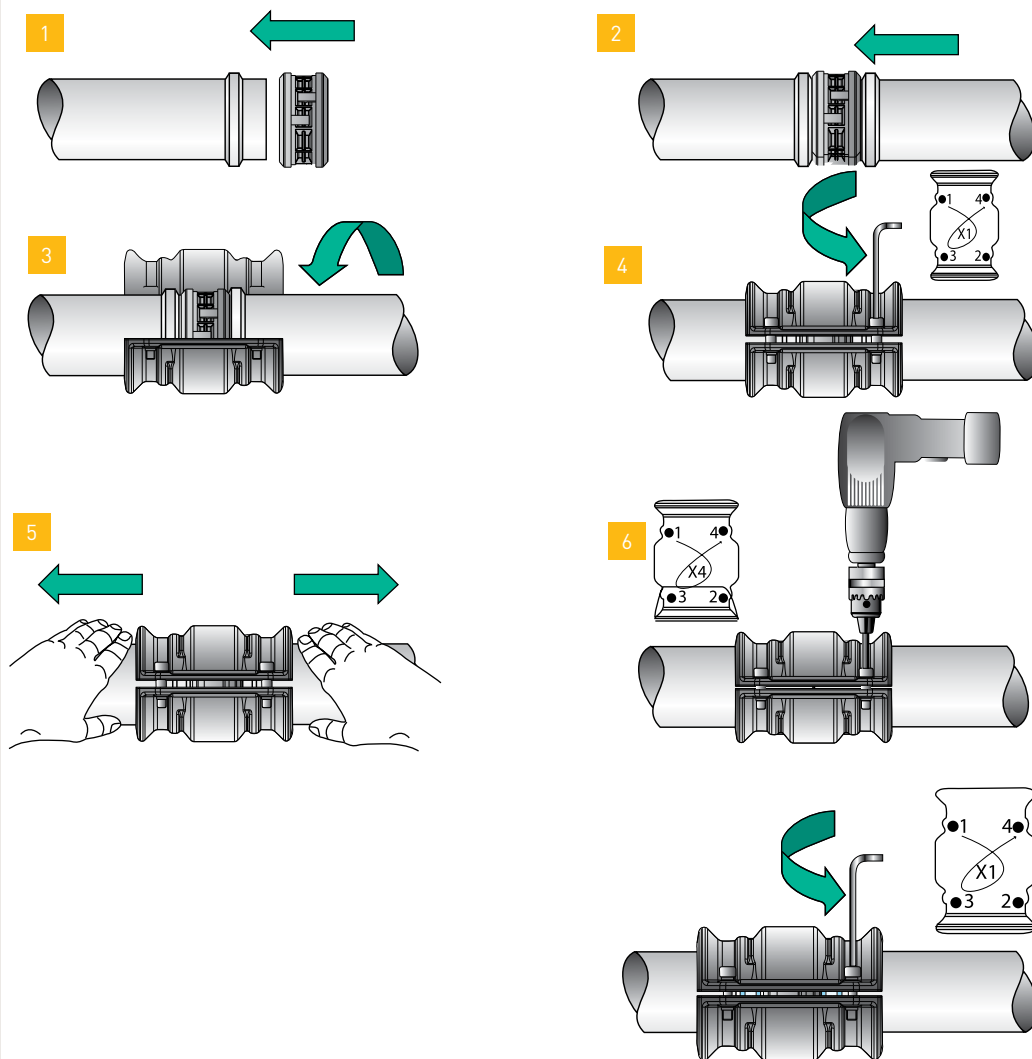

- 1 - Slip the cartridge over the end of the first pipe fully up to the shoulder.
- 2 - Bring the second pipe to the cartridge and slide fully up to the shoulder.
- 3 - Position the clamp over the cartridge / pipe assembly.
- 4 - Hand tighten the pre-fitted screws with a 6mm Allen key.
- 5 - Pull the pipes fully back towards the outside of the clamp.
- 6 - Tighten the clamp screws as follows:
  - mini tightening torque: 10 N.m
  - maxi tightening torque: make the 2 clamps touch together
- 7 - For effective clamp sealing, screw tightening should be performed on alternate sides of the clamp as shown above.

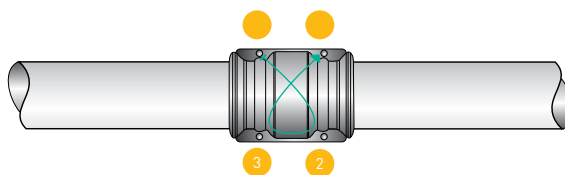

For effective clamp sealing, screw tightening should be performed on alternate sides of the clamp as shown below:



To disconnect, perform the same operations in reverse order.

# TRANSAIR® CONNECTORS

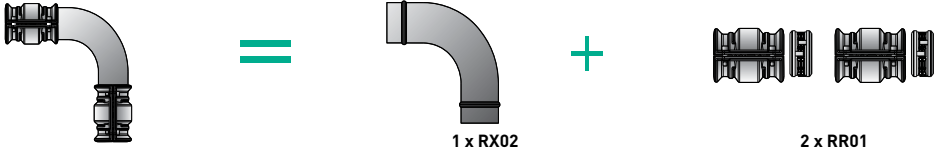
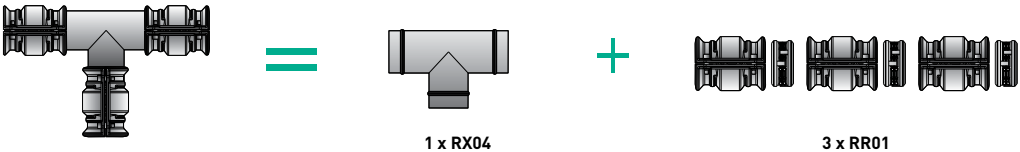
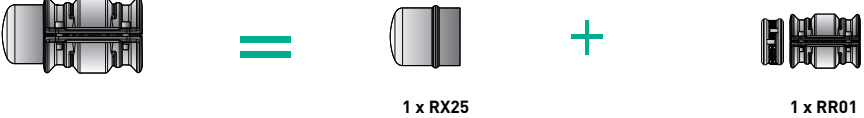
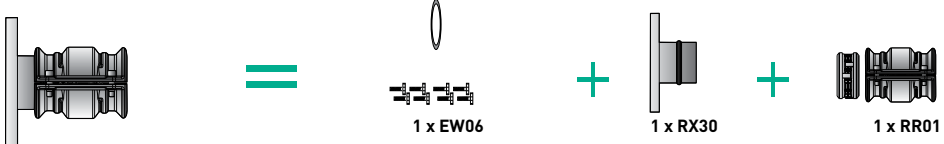
## Practical Examples

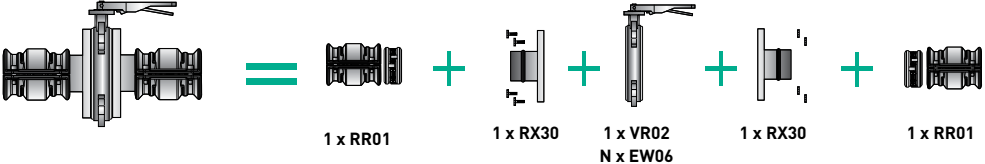
VARIOUS Ø76 AND Ø100 CONFIGURATIONS	
CHANGING DIRECTION WITH A 90° ELBOW	
CHANGING DIRECTION WITH A TEE PIECE	
CONNECTING AN END CAP	
CONNECTING A CIRCULAR FLANGE AND A CONNECTOR	
REDUCTION	
CONNECTING A BUTTERFLY VALVE	

# FIXTURES AND ACCESSORIES

Ø 22  
↓  
Ø 100

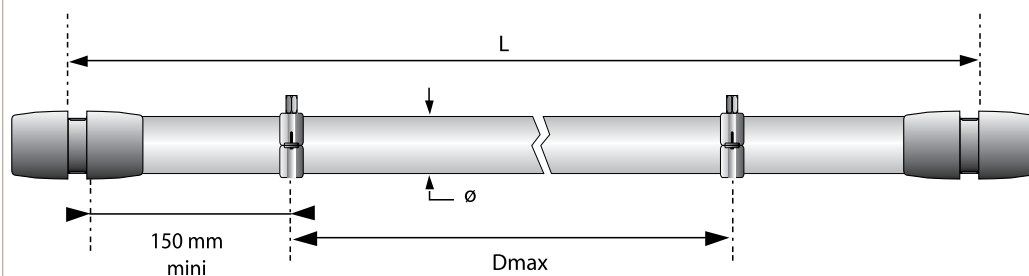

**L = 3 M**

Ø	Dmax (m)
22	2.5
28	2.5
42	2.5
60	2.5
76	2.5
100	2.5

**L = 6 M**

Ø	Dmax (m)
22	3
28	3
42	4
60	4
76	5
100	5

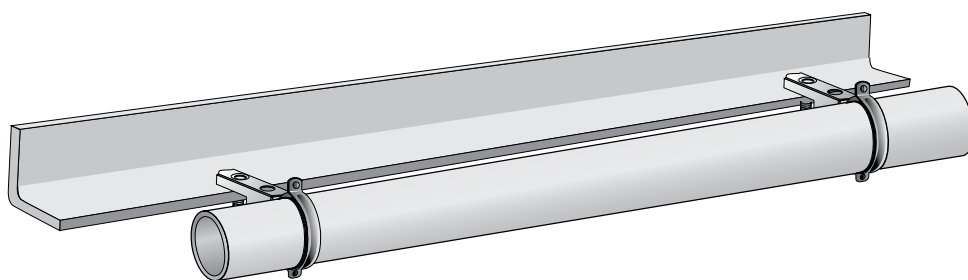

**SCREW TYPE  
BEAM CLAMP**



Position the clamps ref. ER99 onto the RSJ or beam in accordance with the minimum recommended number of attachments per length of pipe and the required distance between attachments, according to the diameter of the pipe.

# TRANSAIR® QUICK ASSEMBLY BRACKETS

## Fitting a Bracket

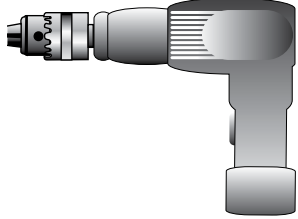
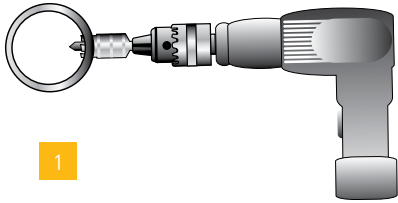
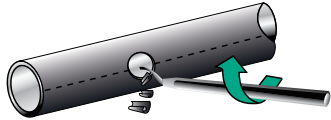
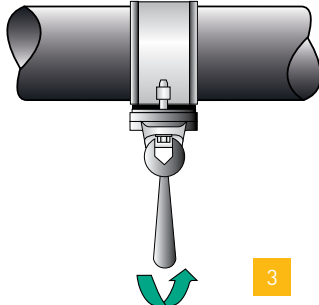
<p>ON Ø 42 Ø 60 Ø 76 Ø 100 PIPE</p>	   <p>TOOLS REQUIRED</p> <p>DRILLING TOOL FOR TRANSAIR® STAINLESS STEEL PIPE EW09 00 22 EW09 00 30</p> <p>DEBURRING TOOL FOR TRANSAIR® STAINLESS STEEL PIPE 6698 04 02</p> <p>DRILL</p>
<p>PROCEDURE</p>	   <p>1 - Drill the Transair® stainless steel pipe at the desired position using following drilling tools:</p> <ul style="list-style-type: none"><li>• Ø42 - Ø60: drilling tool EW09 00 22</li><li>• Ø76 - Ø100: drilling tool EW09 00 30</li></ul> <p>2 - Carefully deburr the pipe.</p> <p>3 - Position the bracket and tighten the 2 screws.</p>

# BENDING A TRANSAIR® STAINLESS STEEL PIPE

## All Diameters

Thanks to their technical characteristics, Transair® stainless steel pipe can be bent according to the following specifications:

Transair®	R min. (mm)	L min. (mm)
Ø 22	44	125
Ø 28	56	125
Ø 42	84	125
Ø 60	93	125
Ø 76	114	125
Ø 100	152	125

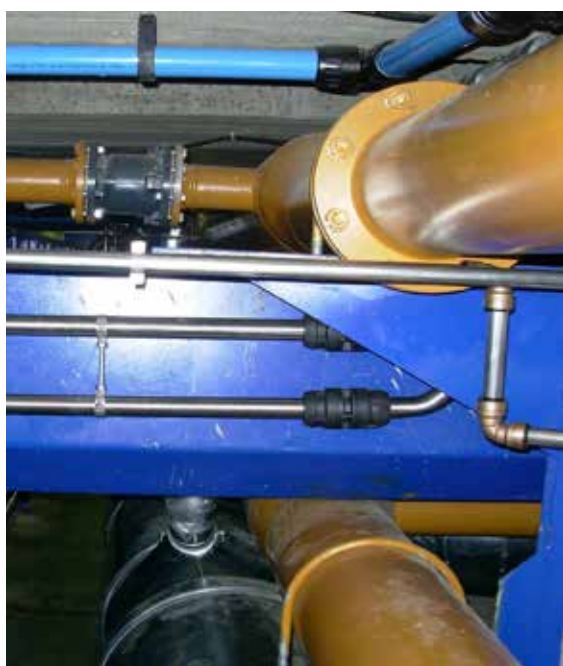
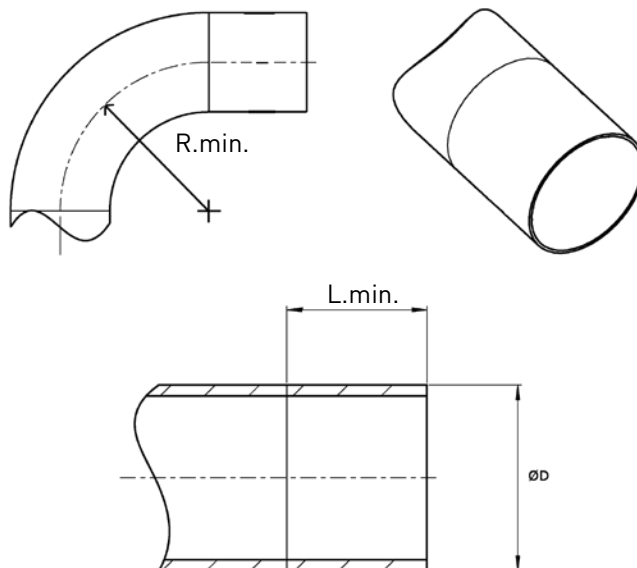

# PRACTICAL INFORMATION

## Z Dimensions

RP02/RR02	Z (mm)
Ø 22	13
Ø 28	15
Ø 42	55
Ø 60	64

RR06	Z (mm)
Ø 22	1.2
Ø 28	1.2
Ø 22 - > Ø 28	1.6
Ø 42	2.6
Ø 60	2.6

RP04	Z1 (mm)	Z2 (mm)
Ø 42	55	55
Ø 60	64	64

RR04	Z1 (mm)	Z2 (mm)
Ø 22	11.7	11
Ø 28	15	15
Ø 28 - > Ø 22	12	16

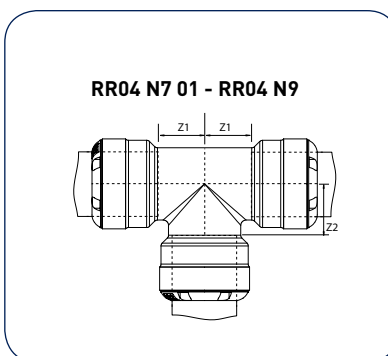
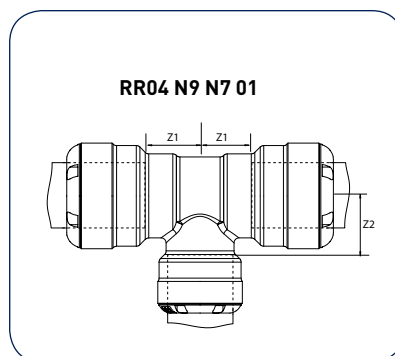
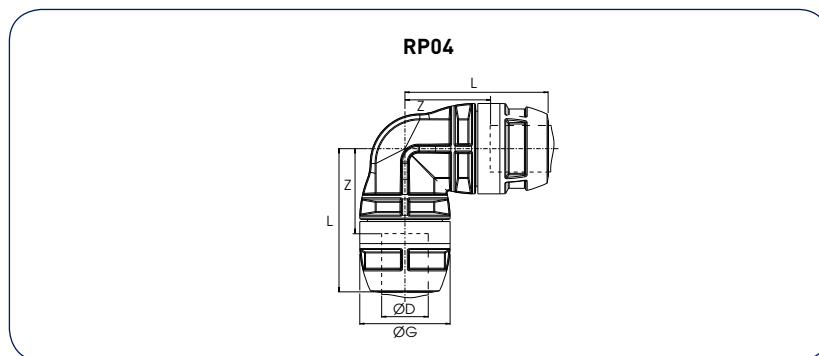
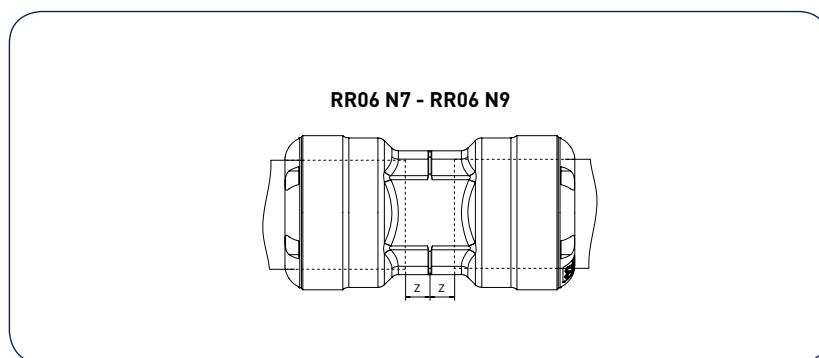
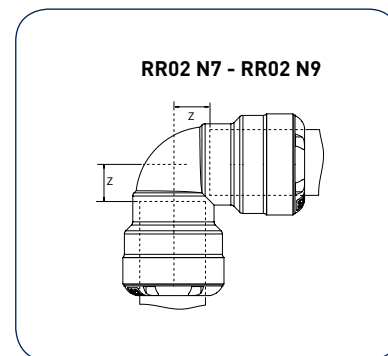
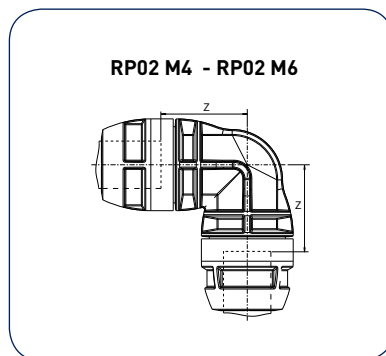

RX04	Z1 (mm)	Z2 (mm)
Ø 76	145	145
Ø 76 -> Ø 42	145	183
Ø 76 -> Ø 60	145	183
Ø 100	155	135
Ø 100 -> Ø 42	155	135
Ø 100 -> Ø 60	155	195
Ø 100 -> Ø 76	155	195

RX02	Z (mm)
Ø 76	189
Ø 100	227

RR05	Z (mm)
RR05 N7 04	21
RR05 N7 06	22
RR05 N9 08	22

RR23/RX23	Z1 (mm)	Z2 (mm)
Ø 22	12	14
Ø 76	145	63
Ø 100	155	76

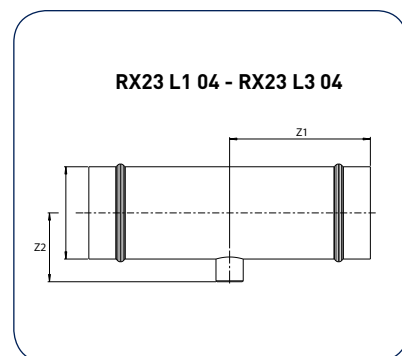
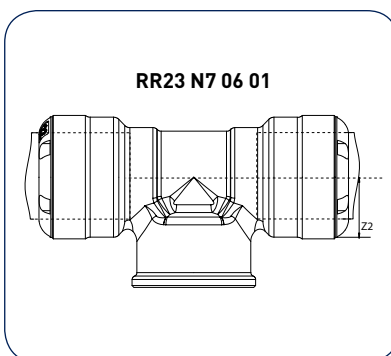
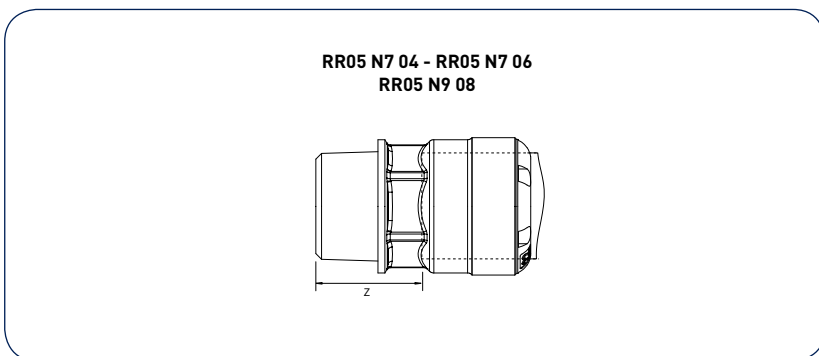
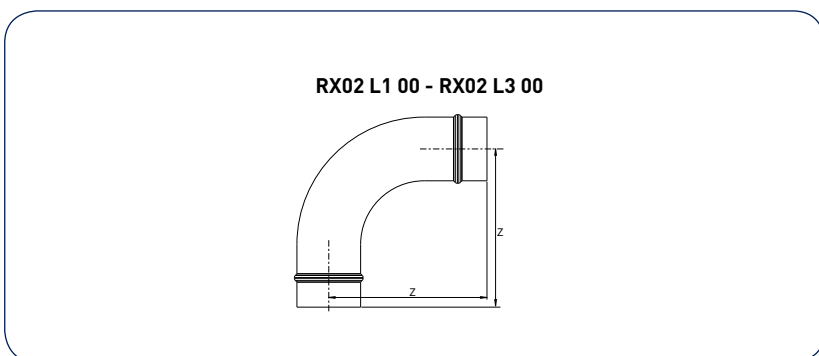
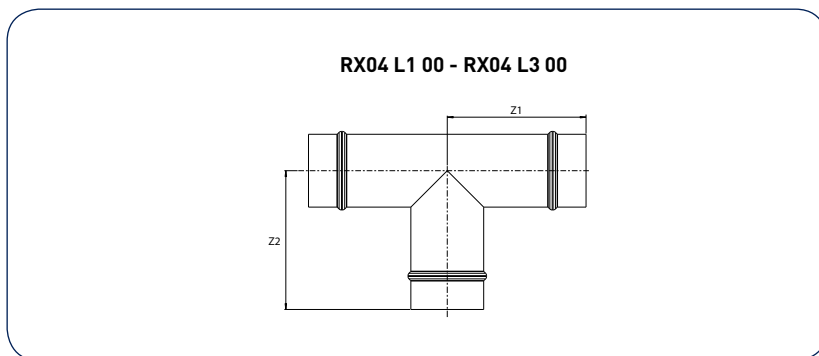



# TRANSAIR®: STAINLESS STEEL DROPS

- ▮ To meet the requirements of compressed air and vacuum applications in **harsh environments** (food and beverage, pharmaceutical or laboratories), Transair® now proposes a complete range of **Ø22 mm 316L stainless steel drops**,
- ▮ These **modular drops with instant connection technology** are very easy to clean and are resistant to **aggressive** chemical agents (list of chemical compatibility available upon request).
- ▮ For food and beverage applications, these drops can be used in **food** or **splash zones** as they are compatible with permanent food contact (316L stainless steel complies with **FDA - CFR21 requirements** for food contact applications).

## TECHNICAL SPECIFICATIONS

- Pipe external diameter: 22 mm
- Pipe internal diameter: 19.6 mm
- Full bore design
- Push-in technology
- Material (fitting and pipe): full stainless steel 316L
- Fittings individually packed in a plastic bag
- Sealing: FKM
- Pressure: 0 to 10 bar
- Temperature: - 20°C to + 120°C
- Vacuum: 10 mbar (absolute value)

## ADVANTAGES AND BENEFITS

- Fully dismountable and reusable
- Instant connection and disconnection
- Modular and flexible networks
- Optimisation of cleaning and maintenance operations
- Large chemical compatibility for applications in aggressive chemical environments (See Chemical Compatibility Chart page 115)
- The 3-port wall bracket facilitates the connection to the process.

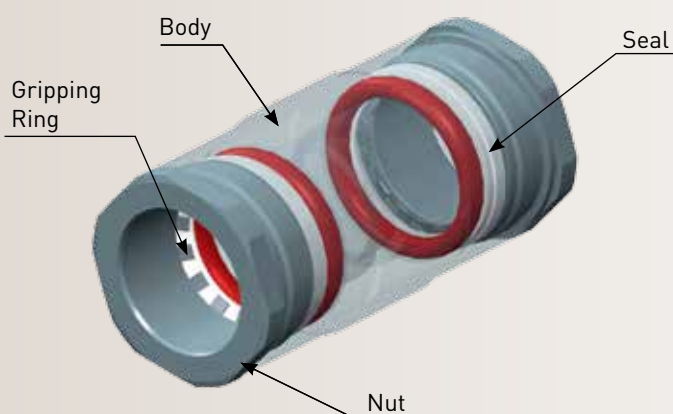

Example of an application in the Food & Beverage Industry: the user needed a full stainless steel 22mm drop in a wash down zone.



### Instructions for Assembly and Disassembly of a Stainless Steel Drop



Assembly: simply push the pipe into the fitting.



Disassembly: **1.** Manually unscrew the nut and slide the nut along the pipe.



Disassembly: **2.** Put the red dismounting ring on the pipe and re-screw the nut on the fitting.



Disassembly: **3.** Pull the pipe from the fitting.

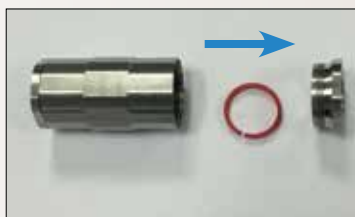

Disassembly: **4.** Manually unscrew the nut and remove the red dismounting ring.

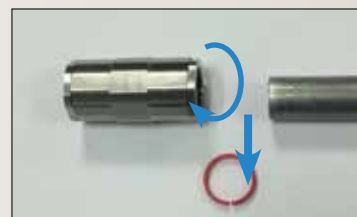

Disassembly: **5.** Re-screw the nut on the fitting without the red ring; it is ready for assembly.

These drops can be connected to quick assembly brackets of Transair® aluminium range (pages 40/41 in this catalogue) and to quick assembly brackets of Transair® stainless steel range (page 129).

	Transair® Part Numbers	Description
	TF03 N7 00 TF06 N7 00	Ø22 Pipe - Stainless Steel 316L - Length: 3 m Ø22 Pipe - Stainless Steel 316L - Length: 6 m
	RF06 N7 02	Pipe-Pipe Connector, Ø22, Stainless Steel 316L FKM
	RF02 N7 00	90° Elbow, Stainless Steel 316L, Ø22 (Bended Pipe)
	RF02 N7 02	90° Elbow, Stainless Steel 316L, Ø22 FKM
	RF04 06 00	Threaded Equal Tee G3/4", Stainless Steel 316L
	RF08 N7 06 02	Male Stud Fitting Ø22, G3/4" FKM, Stainless Steel 316L
	RF35 06 04	G3/4" Wall Bracket > 3 Port G1/2", Stainless Steel 316L (supplied without plug)
	EF25 00 04 02	Stainless Steel Plug, FKM Sealing, for Wall Bracket RF35 06 04
	VF04 00 06	Male Valve R3/4" /Female G3/4", Stainless Steel 316L
	EX01 N7 00	Fixing Clip, Ø22, Stainless Steel 316L
	EW11 N7 00	Red Dismounting Ring, Polymer, Ø22

# PARKER PRODUCTS FROM THE TECHNICAL ROOM



## Coalescing and Activated Carbon Filters for Air and Compressed Gas

Flow rate up to 31.250 m<sup>3</sup>/h. Operating pressure up to 350 bar.  
Designed for air and other compressed gases (natural gas, hydrogen, oxygen, nitrogen, argon, helium, etc.). Deliverables in accordance with the main international bodies (PED, ASME VIII div. 1 and 2, Ghost, China Stamp, LRofS, DNV, GL, ABS, etc.) including directives ISO12500 and ISO8573.1.



## Refrigeration Dryers

- Flow up to 26 400 m<sup>3</sup>/h.
- Operating pressure up to 40 bar.
- Pressure dew point +3 °C.
- Energy-saving system SMART SAVE.



## Transair® System in Aluminium

Transair®: a unique, truly flexible and upgradeable aluminium pipe system.  
Creating primary and secondary networks of the main industrial gases has never been quicker.  
Compatible fluids: air, nitrogen, vacuum and argon, etc.  
Diameters available: 16.5, 25, 40, 50, 63, 76, 100 and 168 mm.  
Tube colours: blue, grey and green. Fittings: BSP and NPT.



## Adsorption Dryers for Compressed Gases and Air

- Flow rate up to 14.500 m<sup>3</sup>/h. Operating pressure up to 350 bar.  
Pressure dew point to -70°C. Designed for air and other compressed gases.
- Patented vacuum regeneration system.
- Compliant with the requirements of main international standards and bodies (PED, ASME VIII div. 1 and 2, Ghost, China Stamp, LRofS, DNV, GL, ABS, etc.).



## Membrane Dryers

- Designed for point of use applications where compact size is a determining factor.
- Flow rate of air up to 1.000 m<sup>3</sup>/h.
- Operating pressure up to 10 bar.
- Pressure dew point to -40°C.
- Operates without electrical supply.



## Breathing Air Systems

- Flow rate up to 850 m<sup>3</sup>/h.
- Operating pressure up to 16 bar.
- Compliant with ISO 12021 and European Pharmacopoeia standards.



## Heat Exchangers with Air and Liquid Cooling Systems

- Flow rate up to 12.000 m<sup>3</sup>/h.
- Designed for applications from 0 to 40 bar.
- Available in stainless steel and other materials resistant to chemical agents.
- Special ranges for biogas and natural gas.
- Bespoke installations according to requirements.

# TO THE HEART OF PRODUCTION

## Chillers for Industrial Cooling

- Refrigerating power up to 757 kW.
- Special external and internal surface treatments for aggressive gases and environments.
- Dedicated equipment for laser applications and special gases (biogas).
- Bespoke installations according to requirements.



## Condensate Drains

- For compressed air lines up to 66.000 m<sup>3</sup>/h.
- Operating pressure up to 50 bar. Designed for corrosive gases and air.
- Float, time delay and electronic level control versions.



## Transair® System in Stainless Steel

Transair®: a flexible and upgradeable stainless steel pipe system for creating primary and secondary industrial water networks.  
Compatible fluids: industrial water, oils, etc.  
Main application: cooling (moulds, tools, welding, etc.)  
Diameters available: 22, 28, 42, 60, 76 and 100 mm.  
Fittings: BSP and NPT.



## Water-Oil Condensate Separators

Available in 7 models for the treatment of condensates generated by compressed air for flow rates up to 3.600 m<sup>3</sup>/h.



## Nitrogen Generators for Industrial and Laboratory Applications.

- To generate ultra-pure nitrogen from compressed air.
- Flow rate of nitrogen produced up to 150 m<sup>3</sup>/h.
- Modular assembly for larger nitrogen flow rates.
- Degree of purity: from 95% to 99.999%.
- Maximum pressure of incoming air: 15.0 bar.
- Maximum pressure of outgoing nitrogen: 13.5 bar.
- Compliant with EIGA standard relating to the food and drink industry



## Nitrogen Membrane Generators

- To generate ultra-pure nitrogen from compressed air.
- Flow rate of nitrogen produced up to 300 m<sup>3</sup>/h.
- Modular assembly for larger nitrogen flow rates.
- Degree of purity: from 95% to 99.5%.
- Maximum pressure of outgoing nitrogen: 13 bar.
- Reduced compressed air consumption per m<sup>3</sup> of nitrogen produced.
- Designed for point-of-use applications.



## Added Value Services

- Contaminant analysis.
- Particle counting
- Humidity testing.
- Breathing air analysis.
- Leak testing.
- Service packages.
- Factory trained technicians.



# PARKER PRODUCTS FROM THE TECHNICAL ROOM

The Parker Solution Couples Excellent Purity of Conveyed Air and Gases with High Flow and Lower Operating Costs

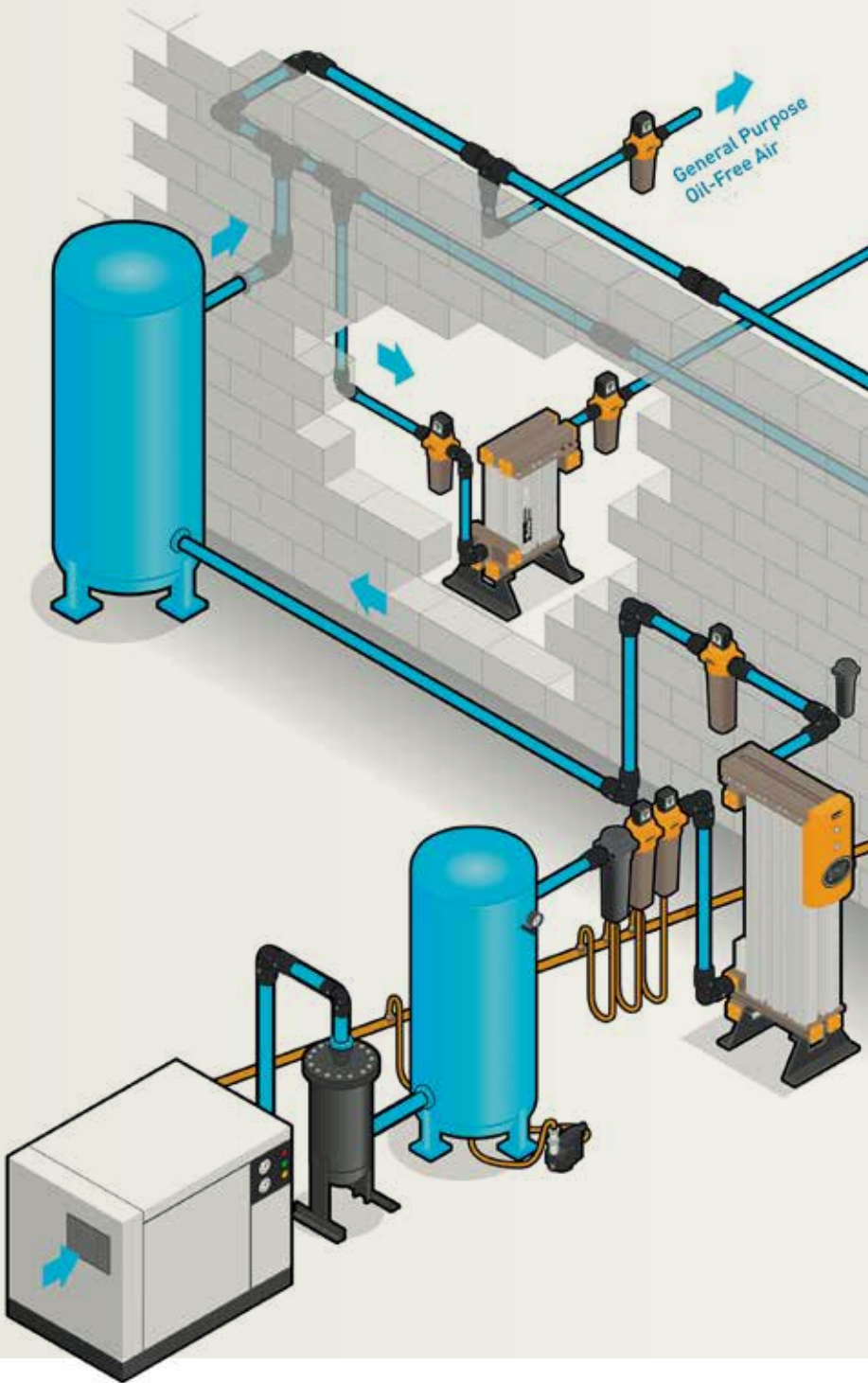

# TO THE HEART OF PRODUCTION

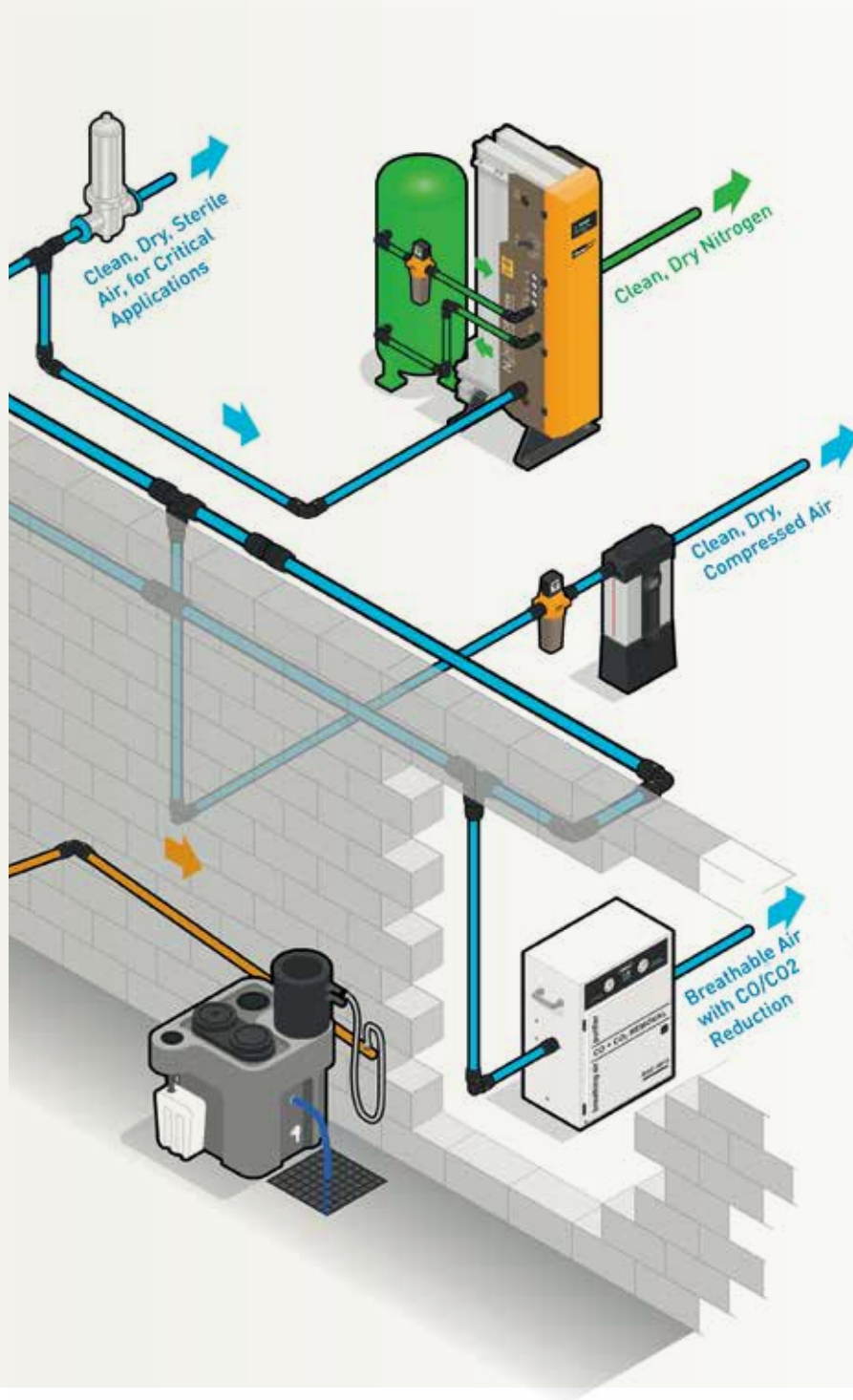

# INDEX

## Transair®

0000 01 68	26, 71	6602 17 00	31	6619 50 48	36	6677 25 A1	47	6798 00 03	55
0697 00 02TR	57	6602 25 00	31	6619 50 49	36	6677 25 E4	47	6798 00 04	55
0697 00 03TR	57	6602 40 00	31	6619 63 47	36	6677 25 U1	47	6798 00 05	53, 55
0697 00 04TR	57	6602 50 00	31	6619 63 48	36	6677 25 U2	47	6798 00 06	53, 55
0697 00 05TR	57	6602 63 00	31	6621 17 21	36	6678 17 21	44	6798 00 07	55
0697 00 06TR	57	6604 17 00	32	6621 25 21	36	6678 25 21	44	6798 00 08	55
0697 00 07TR	57	6604 25 00	32	6621 25 27	36	6681 17 21	45	9A86 01 10X099	61
0697 00 08TR	57	6604 40 00	32	6621 25 34	36	6681 25 21	45	9A86 01 13X099	61
0697 00 09TR	57	6604 50 00	32	6621 40 42	36	6682 17 21	45	9A86 01 70X099	61
1001E25 00 01	29, 93	6604 50 25	32	6621 40 49	36	6682 25 21	45	9A86 02 13X099	61
1001E25 00 03	29, 93	6604 50 40	32	6625 17 00	34	6686 21 21	46, 129	9A86 02 17X099	61
1001E25 00 04	29, 93	6604 63 00	32	6625 25 00	34	6690 21 21	46, 129	9A86 02 21X099	61
1001E40 00 02	29, 93	6604 63 40	32	6625 40 00	34	6692 17 A1	47	9A86 03 17X099	61
1001E40 00 04	29, 93	6604 63 50	32	6625 50 00	34	6692 17 E4	47	9A86 03 21X099	61
1001E40 00 05	29, 93	6605 17 13	35	6625 63 00	34	6692 17 U1	47	9A87 01 10X099	61
1001E50 00 04	29, 93	6605 17 21	35	6635 27 21	46, 129	6692 17 U2	47	9A87 01 13X099	61
1001E50 00 09	29, 93	6605 25 21	35	6637 25 21	44	6692 25 A1	47	9A87 01 17X099	61
1001E63 00 05	29, 93	6605 25 27	35	6639 17 21	45	6692 25 E4	47	9A87 02 13X099	61
1001E63 00 06	29, 93	6605 25 34	35	6639 25 21	45	6692 25 U1	47	9A87 02 17X099	61
1001E63 00 08	29, 93	6605 40 34	35	6641 21 21	46, 129	6692 25 U2	47	9A87 02 21X099	61
1003A17 04 00	26	6605 40 42	35	6651 25 12 04	37	6693 17 21	44	9A87 03 17X099	61
1003A17 06 00	26	6605 40 49	35	6651 40 12 04	37	6693 25 21	44	9A87 03 21X099	61
1003A25 04 00	26	6605 50 48	35	6652 25 21 06	37	6695 25 21	45	9A87 03 21X099	61
1003A25 06 00	26	6605 50 49	35	6652 40 21 06	37	6697 00 02	28, 98, 101	9A94 01 06X099	61
1003A40 04 00	26	6605 63 47	35	6660 25 A1	42	6697 00 03	28, 99	9A94 01 10X099	61
1003A40 06 00	26	6605 63 48	35	6660 25 E4	42	6697 17 00	28	9A94 01 13X099	61
1003A50 04	27	6606 17 00	30	6660 25 U1	42	6697 25 00	28	9A94 02 06X099	61
1003A50 06	27	6606 25 00	30	6660 25 U2	42	6697 40 00	28	9A94 02 08X099	61
1003A63 04	27	6606 40 00	30	6660 40 A1	42	6697 50 00	28	9A94 02 10X099	61
1003A63 06	27	6606 50 00	30	6660 40 E4	42	6697 63 00	28	9A94 02 13X099	61
1004A17 02	26	6606 63 00	30	6660 40 U1	42	6698 00 05	48	9A94 03 08X099	61
1004A17 04	26	6609 17 13	36	6660 40 U2	42	6698 01 03	48, 73, 89	9A94 03 13X099	61
1006A25 02 00	26	6609 17 21	36	6661 25 21	41	6698 02 01	48, 73, 89	9A94 03 16X099	61
1006A25 04 00	26	6609 25 21	36	6661 40 21	41	6698 02 02	48, 89	9D01 01 13P483	60
1006A25 06 00	26	6609 25 27	36	6661 40 27	41	6698 03 01	48, 132	9D01 01 17P483	60
1006A40 02 00	26	6609 25 34	36	6661 50 21	41	6698 04 01	49, 72, 139	9D01 01 21P483	60
1006A40 04 00	26	6609 40 34	36	6661 50 27	41	6698 04 02	48, 49	9D01 02 13P483	60
1006A40 06 00	26	6609 40 42	36	6661 63 21	41	6698 04 03	49, 72	9D01 02 17P483	60
1006A50 02	27	6609 40 48	36	6661 63 27	41	6698 05 03	49, 132	9D01 02 21P483	60
1006A50 04	27	6609 40 49	36	6662 25 00	41	6698 10 01	56	9D05 09 13P4	60
1006A50 06	27	6609 50 48	36	6662 25 17	41	6698 10 02	56	9D05 09 17P4	60
1006A63 02	27	6609 50 49	36	6662 40 17	41	6698 11 01	56	9D05 09 21P4	60
1006A63 04	27	6609 63 47	36	6662 40 25	41	6698 11 98	56	9D05 10 13P4	60
1006A63 06	27	6609 63 48	36	6662 50 25	41	6698 99 03	29, 93	9D05 10 17P4	60
1025V12 04 06TR	57	6611 17 21	35	6662 63 25	41	6698 99 07	29, 93	9D05 10 21P4	60
1025V14 04 08TR	57	6611 25 21	35	6666 17 25	34	6699 01 01	51, 100	9D14 01 13P483	60
1025V16 04 10TR	57	6611 25 27	35	6666 25 40	34	6699 01 02	51, 100	9D14 01 17P483	60
1025V20 04 13TR	57	6611 25 34	35	6666 25 50	34	6699 01 03	51, 100	9D14 01 21P483	60
1025V24 04 16TR	57	6611 40 34	35	6666 40 50	34	6699 01 04	51, 100	9D14 02 13P483	60
1025V28 04 20TR	57	6611 40 42	35	6666 40 63	34	6699 01 06	51	9D14 02 17P483	60
1025V34 04 25TR	57	6611 40 48	35	6666 50 63	34	6699 02 01	52	9D14 02 21P483	60
1025V41 04 32TR	57	6611 40 49	35	6669 25 21	42	6699 02 02	52	9D14 03 17P483	60
1025V50 04 40TR	57	6611 50 48	35	6669 40 21	42	6699 02 03	52	9D14 03 21P483	60
1470U06 04 13TR	56	6611 50 49	35	6669 40 27	42	6699 02 04	52	9D14 09 13P4	60
1470U08 04 13TR	56	6611 63 47	35	6669 50 21	42	6699 02 05	52	9D14 09 17P4	60
1470U10 04 13TR	56	6611 63 48	35	6669 50 27	42	6699 02 06	52	9D14 09 21P4	60
1470U12 04 17TR	56	6612 25 00	31	6669 63 21	42	6699 03 01	52	9D14 10 13P4	60
1471U06 04 13TR	56	6612 40 00	31	6669 63 27	42	6699 03 02	51, 102	9D14 10 17P4	60
1471U08 04 13TR	56	6612 50 00	31	6671 17 A1	47	6699 10 01	52, 103	9D14 10 21P4	60
1471U10 04 13TR	56	6612 63 00	31	6671 17 E4	47	6699 10 02	52, 103	9D21 01 06P483	60
1471U12 04 17TR	56	6615 25 21	35	6671 17 U1	47	6699 10 03	50	9D21 01 08P483	60
1472U08 04 13TR	56	6615 25 27	35	6671 17 U2	47	6700 00 13	53, 55	9D21 01 09P483	60
1472U10 04 13TR	56	6615 25 34	35	6671 25 A1	47	6700 00 21	53, 55	9D21 01 13P483	60
1472U12 04 17TR	56	6615 40 42	35	6671 25 E4	47	6701 00 13	53, 55	9D21 02 10P483	60
4092 17 00	38	6615 40 49	35	6671 25 U1	47	6701 00 21	53, 55	9D21 02 13P483	60
4092 25 00	38	6615 50 48	35	6671 25 U2	47	6702 00 13	54	9D21 02 13P483	60
4092 40 00	38	6615 50 49	35	6676 25 00	30	6702 00 21	54	9D21 03 13P483	60
4092 50 00	38	6619 25 21	36,	6676 40 00	30	6703 00 13	54	9D21 09 06P4	60
4092 63 00	38	6619 25 27	36,	6676 50 00	30	6703 00 21	54	9D21 09 08P4	60
4230 00 40	39	6619 25 34	36,	6676 63 00	30	6706 00 21	55	9D21 09 10P4	60
4299 03 01	39	6619 40 34	36	6677 17 A1	47	6708 00 13	53	9D21 10 08P4	60
4981 10 21TR	39	6619 40 42	36	6677 17 E4	47	6708 00 21	53	9D21 10 10P4	60
		6619 40 48	36	6677 17 U1	47	6798 00 01	55	CA86 A1 02	59
		6619 40 49	36	6677 17 U2	47	6798 00 02	55	CA86 A1 03	59

CA86 A1 04	59	EA98 06 03	43, 92	EW02 M4 00	132, 140	RA26 L3 L1	33	RR06 N7 01	124
CA86 E4 02	59	EA98 06 04	43, 92	EW02 M6 00	132, 140	RA26 L8 00	33	RR06 N7 02	124
CA86 E4 03	59	EF00 00 02	62	EW03 00 01	50	RA26 L8 L3	33	RR06 N9 01	124
CA86 E4 04	59	EF00 00 04	62	EW05 63 00	37	RA30 63 00	37	RR06 N9 02	124
CA86 U1 02	59, 61	EF00 00 06	62	EW05 K2 00	37	RA30 L1 00	37	RR14 M4 06	127
CA86 U1 03	59, 61	EF00 00 08	62	EW05 L1 00	37	RA30 L3 00	37	RR14 M4 08	127
CA86 U1 04	59, 61	EF00 02 03	62	EW05 L1 00 01	130, 131	RA30 L8 K2	37	RR14 M6 06	127
CA86 U2 02	59, 61	EF00 02 04	62	EW05 L1 01	130, 131	RA31 L8 00	37	RR14 M6 08	127
CA86 U2 03	59, 61	EF00 03 04	62	EW05 L3 00	37	RA33 L1 24	37	RR23 N7 06 01	127
CA86 U2 04	59, 61	EF00 04 06	62	EW05 L3 01	130, 131	RA33 L3 24	37	RR23 N7 06 02	127
CA87 A1 02	59	EF00 06 08	62	EW05 L8 00	37	RA44 L1 00 45	33	RR25 M4 00	128
CA87 A1 03	59	EF02 00 02	62	EW05 M4 01	130, 131	RA44 L3 00 45	33	RR25 M6 00	128
CA87 A1 04	59	EF02 00 03	62	EW05 M6 01	130, 131	RA44 L8 00 45	33	RR25 N7 01	128
CA87 E4 02	59	EF02 00 04	62	EW06 00 01	131	RA65 25 04	40	RR25 N7 02	128
CA87 E4 03	59	EF02 00 06	62	EW06 00 02	38	RA65 40 04	40	RR25 N9 01	128
CA87 E4 04	59	EF02 02 03	62	EW06 00 03	37, 130	RA65 50 04	40	RR25 N9 02	128
CA87 U1 02	59, 61	EF02 02 04	62	EW06 00 07	38	RA65 50 08	40	RR61 L1 08	40
CA87 U1 03	59, 61	EF02 03 04	62	EW06 00 08	37	RA65 63 04	40	RR61 L1 16	40
CA87 U1 04	59, 61	EF02 04 06	62	EW06 00 09	38	RA65 63 08	40	RR61 L3 08	40
CA87 U2 02	59, 61	EF04 01 02	63	EW06 00 15	38	RA66 L8 L1	34	RR61 L3 16	40
CA87 U2 03	59, 61	EF04 02 03	63	EW06 00 17	38	RA66 L8 L3	34	RR63 L8 12	40
CA87 U2 04	59, 61	EF04 02 04	63	EW07 00 01	26	RA69 25 17	40	RR63 L8 16	40
CA94 A1 06	59	EF04 03 04	63	EW08 00 01	74	RA69 40 25	40	RR63 L8 20	40
CA94 A1 08	59	EF04 04 06	63	EW08 00 03	48, 74, 132	RA69 50 25	40	RR63 L8 24	40
CA94 A1 10	59	EF06 02 03	63	EW09 00 22	48, 132	RA69 63 25	40	RR82 L1 08 01	129
CA94 E4 08	59	EF06 02 04	63	EW09 00 30	48, 90, 132	RF02 N7 00	153	RR82 L1 08 02	129
CA94 E4 10	59	EF06 03 04	63	EW09 00 51	48, 90	RF02 N7 02	153	RR82 L3 08 01	129
CA94 E4 13	59	EF06 04 06	63	EW09 00 64	48, 90	RF04 06 00	153	RR82 L3 08 02	129
CA94 U1 06	59	EF06 04 08	63	EW09 00 70	48, 90	RF06 N7 02	153	RR82 M4 06 01	129
CA94 U1 08	59	EF06 06 08	63	EW09 00 90	48, 90	RF08 N7 06 02	153	RR82 M4 06 02	129
CA94 U1 10	59	EF06 08 10	63	EW10 N7 01	132	RF35 06 04	153	RR82 M6 06 01	129
CA94 U2 08	59	EF10 00 04	64	EW10 N7 02	132	RP02 M4 01	125	RR82 M6 06 02	129
CA94 U2 10	59	EF11 00 04	64	EW10 N9 01	132	RP02 M4 02	125	RX02 L1 00	31, 125
CA94 U2 13	59	EF12 00 04	64	EW10 N9 02	132	RP02 M6 01	125	RX02 L3 00	31, 125
CP01 A1 02	58	EF13 00 02	64	EW11 00 01	132	RP02 M6 02	125	RX04 L1 00	32, 126
CP01 A1 03	58	EF13 00 04	64	EW11 N7 00	153	RP04 M4 01	126	RX04 L1 M4	126
CP01 A1 04	58	EF14 00 04	64	EX01 L1 00	123	RP04 M4 02	126	RX04 L1 M6	126
CP01 E4 02	58	EF15 00 04	65	EX01 L3 00	123	RP04 M6 01	126	RX04 L3 00	32, 126
CP01 E4 03	58	EF16 00 04	65	EX01 M4 00	123	RP04 M6 02	126	RX04 L3 L1	32, 126
CP01 E4 04	58	EF17 00 02	65	EX01 M6 00	123	RP06 M4 01	124	RX04 L3 M4	126
CP01 U1 02	58	EF17 00 04	65	EX01 N7 00	153	RP06 M4 02	124	RX04 L3 M6	126
CP01 U1 03	58	EF25 00 04 02	153	FP01 L1 01	29, 93	RP06 M6 01	124	RX12 L1 00	31, 125
CP01 U1 04	58	EF26 06 01	57, 65	FP01 L1 02	29, 93	RP06 M6 02	124	RX12 L3 00	31, 125
CP01 U2 02	58	EF26 06 02	57, 65	FP01 L3 02	29	RR01 L1 00	30	RX12 M4 00	125
CP01 U2 03	58	EF26 08 02	57, 65	FP01 L3 03	29, 93	RR01 L1 01	124	RX12 M6 00	125
CP01 U2 04	58	EF26 08 03	57, 65	FX01 L8 02	29, 93	RR01 L1 02	124	RX23 L1 04	33, 127
CP14 A1 02	58	EF26 10 02	57, 65	RA02 L8 00	31	RR01 L3 00	30	RX23 L3 04	33, 127
CP14 A1 03	58	EF26 10 03	57, 65	RA04 63 L1	32	RR01 L3 01	124	RX24 L1 40	32
CP14 A1 04	58	EF26 10 04	57, 65	RA04 L1 L3	32	RR01 L3 02	124	RX24 L1 50	32
CP14 E4 02	58	EF26 13 02	57, 65	RA04 L3 L8	32	RR01 L8 00	30	RX24 L1 63	32
CP14 E4 03	58	EF26 13 03	57, 65	RA04 L8 00	32	RR02 N7 01	125	RX24 L3 40	32
CP14 E4 04	58	EF26 13 04	57, 65	RA04 L8 63	32	RR02 N7 02	125	RX24 L3 50	32
CP14 U1 02	58	EF26 16 03	57, 65	RA04 L8 L1	32	RR02 N9 01	125	RX24 L3 63	32
CP14 U1 03	58	EF26 16 04	65	RA04 L8 L3	32	RR02 N9 02	125	RX25 L1 00	128
CP14 U1 04	58	EF26 20 06	65	RA07 40 00	33	RR04 N7 01	126	RX25 L3 00	128
CP14 U2 02	58	EF26 25 08	65	RA07 50 00	33	RR04 N7 02	126	RX30 L1 00	130
CP14 U2 03	58	EF26 32 10	65	RA07 63 00	33	RR04 N9 01	126	RX30 L1 00 01	130
CP14 U2 04	58	EF26 40 12	65	RA07 L1 00	33	RR04 N9 02	126	RX30 L3 00	130
CP21 A1 06	58	ER01 L1 00	28, 123	RA07 L1 03 45	33	RR04 N9 N7 01	126	RX30 M4 00	130
CP21 A1 08	58	ER01 L3 00	28, 123	RA07 L3 00	33	RR04 N9 N7 02	126	RX30 M6 00	130
CP21 A1 10	58	ER01 L8 00	28	RA07 L3 03 45	33	RR05 L1 20	36, 128	RX64 L1 50	34
CP21 E4 08	58	ER01 M4 00	123	RA07 L8 00	33	RR05 L1 24	36	RX64 L1 63	34
CP21 E4 10	58	ER01 M6 00	123	RA07 L8 03 45	33	RR05 M4 06	128	RX64 L3 50	34
CP21 E4 13	58	ER01 N7 00	123	RA12 L8 00	31	RR05 M4 10	128	RX64 L3 63	34
CP21 U1 06	58	ER01 N9 00	123	RA25 L1 04	34	RR05 M4 12	128	RX66 L1 M6	127
CP21 U1 08	58	ER99 05 02	52, 133	RA25 L3 04	34	RR05 M6 06	128	RX66 L3 L1	34, 127
CP21 U1 10	58	ER99 05 03	52, 133	RA25 L8 04	34	RR05 M6 16	128	RX66 M6 M4	127
CP21 U2 08	58	ER99 06 02	52, 133	RA26 63 00	33	RR05 M6 20	128	TA03 L1 04	27
CP21 U2 10	58	ER99 06 03	52, 133	RA26 L1 00	33	RR05 N7 04 01	128	TA03 L3 04	27
CP21 U2 13	58	EW01 00 01	50, 74, 132, 140	RA26 L1 40	33	RR05 N7 04 02	128	TA03 L8 04	27
EA59 00 13	56	EW01 00 03	50, 74, 132, 140	RA26 L1 50	33	RR05 N7 06 01	128	TA06 L1 04	27
EA98 06 00	43, 49, 92	EW02 L1 00	50, 74, 132, 140	RA26 L1 63	33	RR05 N7 06 02	128	TA06 L1 06	27
EA98 06 01	43, 92	EW02 L3 00	50, 74, 132, 140	RA26 L3 00	33	RR05 N9 08 01	128	TA06 L3 04	27
EA98 06 02	43, 92	EW02 L8 00	50, 74	RA26 L3 63	33	RR05 N9 08 02	128	TA06 L3 06	27



# INDEX

TA06 L8 04	27
TA06 L8 06	27
TF03 N7 00	122, 153
TF03 N9 00	122
TF06 N7 00	122, 153
TF06 N9 00	122
TX03 L1 00	122
TX03 L3 00	122
TX03 M4 00	122
TX03 M6 00	122
TX06 L1 00	122
TX06 L3 00	122
TX06 M4 00	122
TX06 M6 00	122
VF04 00 06	153
VR01 L1 00	38
VR01 L3 00	38
VR01 L8 00	38
VR02 63 00	38
VR02 L1 00	38
VR02 L1 01	130
VR02 L1 02	130
VR02 L3 00	38
VR02 L3 01	130
VR02 L3 02	130
VR02 L8 00	38
VR02 M4 01	130
VR02 M4 02	130
VR02 M6 01	130
VR02 M6 02	130
VR03 00 02	39, 131
VR03 00 03	39, 131
VR03 00 04	39, 131
VR03 00 06	39, 131
VR03 00 08	39, 131
VR03 00 10	39, 131
VR03 00 12	39, 131
VR03 00 16	39, 131
VR03 00 20	39, 131
VR04 00 04	39, 131
VR04 00 06	39, 131
VR04 00 08	39, 131
VR04 00 10	39, 131
VR04 00 12	39, 131
VR04 00 16	39, 131
VR04 00 20	39, 131

Parker Transair has a policy of continuous product development and therefore reserves the right to modify any products shown in this catalogue, without notification. All dimensions, drawings and pictures are indicative.

# Parker Worldwide

## Europe, Middle East, Africa

**AE – United Arab Emirates,**  
Dubai

Tel: +971 4 8127100  
parker.me@parker.com

**AT – Austria,** Wiener Neustadt

Tel: +43 (0)2622 23501-0  
parker.austria@parker.com

**AT – Eastern Europe,** Wiener  
Neustadt

Tel: +43 (0)2622 23501 900  
parker.easteurope@parker.com

**AZ – Azerbaijan,** Baku

Tel: +994 50 2233 458  
parker.azerbaijan@parker.com

**BE/LU – Belgium,** Nivelles

Tel: +32 (0)67 280 900  
parker.belgium@parker.com

**BG – Bulgaria,** Sofia

Tel: +359 2 980 1344  
parker.bulgaria@parker.com

**BY – Belarus,** Minsk

Tel: +48 (0)22 573 24 00  
parker.poland@parker.com

**CH – Switzerland,** Etoy

Tel: +41 (0)21 821 87 00  
parker.switzerland@parker.com

**CZ – Czech Republic,** Klecany

Tel: +420 284 083 111  
parker.czechrepublic@parker.com

**DE – Germany,** Kaarst

Tel: +49 (0)2131 4016 0  
parker.germany@parker.com

**DK – Denmark,** Ballerup

Tel: +45 43 56 04 00  
parker.denmark@parker.com

**ES – Spain,** Madrid

Tel: +34 902 330 001  
parker.spain@parker.com

**FI – Finland,** Vantaa

Tel: +358 (0)20 753 2500  
parker.finland@parker.com

**FR – France,** Contamine s/Arve

Tel: +33 (0)4 50 25 80 25  
parker.france@parker.com

**GR – Greece,** Athens

Tel: +30 210 933 6450  
parker.greece@parker.com

**HU – Hungary,** Budaörs

Tel: +36 23 885 470  
parker.hungary@parker.com

**IE – Ireland,** Dublin

Tel: +353 (0)1 466 6370  
parker.ireland@parker.com

**IT – Italy,** Corsico (MI)

Tel: +39 02 45 19 21  
parker.italy@parker.com

**KZ – Kazakhstan,** Almaty

Tel: +7 7273 561 000  
parker.easteurope@parker.com

**NL – The Netherlands,** Oldenzaal

Tel: +31 (0)541 585 000  
parker.nl@parker.com

**NO – Norway,** Asker

Tel: +47 66 75 34 00  
parker.norway@parker.com

**PL – Poland,** Warsaw

Tel: +48 (0)22 573 24 00  
parker.poland@parker.com

**PT – Portugal,** Leca da Palmeira

Tel: +351 22 999 7360  
parker.portugal@parker.com

**RO – Romania,** Bucharest

Tel: +40 21 252 1382  
parker.romania@parker.com

**RU – Russia,** Moscow

Tel: +7 495 645-2156  
parker.russia@parker.com

**SE – Sweden,** Spånga

Tel: +46 (0)8 59 79 50 00  
parker.sweden@parker.com

**SK – Slovakia,** Banská Bystrica

Tel: +421 484 162 252  
parker.slovakia@parker.com

**SL – Slovenia,** Novo Mesto

Tel: +386 7 337 6650  
parker.slovenia@parker.com

**TR – Turkey,** Istanbul

Tel: +90 216 4997081  
parker.turkey@parker.com

**UA – Ukraine,** Kiev

Tel: +48 (0)22 573 24 00  
parker.poland@parker.com

**UK – United Kingdom,** Warwick

Tel: +44 (0)1926 317 878  
parker.uk@parker.com

**ZA – South Africa,** Kempton Park

Tel: +27 (0)11 961 0700  
parker.southafrica@parker.com

## North America

**CA – Canada,** Milton, Ontario

Tel: +1 905 693 3000

**US – USA,** Cleveland

Tel: +1 216 896 3000

## Asia Pacific

**AU – Australia,** Castle Hill

Tel: +61 (0)2-9634 7777

**CN – China,** Shanghai

Tel: +86 21 2899 5000

**HK – Hong Kong**

Tel: +852 2428 8008

**IN – Inde,** Gurgaon

Tél: +91 124 459 0600  
legris.india@parker.com

**JP – Japan,** Tokyo

Tel: +81 (0)3 6408 3901

**KR – South Korea,** Seoul

Tel: +82 2 559 0400

**MY – Malaysia,** Shah Alam

Tel: +60 3 7849 0800

**NZ – New Zealand,** Mt Wellington

Tel: +64 9 574 1744

**SG – Singapore**

Tel: +65 6887 6300

**TH – Thailand,** Bangkok

Tel: +662 186 7000

**TW – Taiwan,** Taipei

Tel: +886 2 2298 8987

## South America

**AR – Argentina,** Buenos Aires

Tel: +54 3327 44 4129

**BR – Brazil,** Sao Jose dos Campos

Tel: +55 800 727 5374

**CL – Chile,** Santiago

Tel: +56 2 623 1216

**MX – Mexico,** Toluca

Tel: +52 72 2275 4200

European Product Information Centre

Free phone: 00 800 27 27 5374

(from AT, BE, CH, CZ, DE, DK, EE, ES, FI,  
FR, IE, IL, IS, IT, LU, MT, NL, NO, PL, PT, RU,  
SE, SK, UK, ZA)

## Fluid System Connectors Division Europe

Transair Business Unit

Parc Alcyone - Building D

1, rue André et Yvonne Meynier

CS 46911 - 35069 Rennes - France

Tel: +33 (0)2 99 25 55 00

Fax: +33 (0)2 99 25 56 47

transair@parker.com - www.parkertransair.com