



aerospace
climate control
electromechanical
filtration
fluid & gas handling
hydraulics
pneumatics
process control
sealing & shielding



Push buttons and Visual indicators

Catalogue PDE2587TCUK June 2010



ENGINEERING YOUR SUCCESS.

 **WARNING**

FAILURE OR IMPROPER SELECTION OR IMPROPER USE OF THE PRODUCTS AND/OR SYSTEMS DESCRIBED HEREIN OR RELATED ITEMS CAN CAUSE DEATH, PERSONAL INJURY AND PROPERTY DAMAGE.

This document and other information from Parker Hannifin Corporation, its subsidiaries and authorized distributors provide product and/or system options for further investigation by users having technical expertise. It is important that you analyze all aspects of your application and review the information concerning the product or system in the current product catalog. Due to the variety of operating conditions and applications for these products or systems, the user, through its own analysis and testing, is solely responsible for making the final selection of the products and systems and assuring that all performance, safety and warning requirements of the application are met. The products described herein, including without limitation, product features, specifications, designs, availability and pricing, are subject to change by Parker Hannifin Corporation and its subsidiaries at any time without notice.

SALE CONDITIONS

The items described in this document are available for sale by Parker Hannifin Corporation, its subsidiaries or its authorized distributors. Any sale contract entered into by Parker will be governed by the provisions stated in Parker's standard terms and conditions of sale (copy available upon request).

Push button valves Ø 22	Page
Generalities	4
Spring return pushbuttons	4
Mushroom head pushbuttons	4
Selector switches	5
Switch bodies with operating head mounting	5
Additional switch valves	5
Electrical contact blocks	5
Mounting block for valves and operating heads	6
Operating heads	6 - 7
Joystick controllers	7
Dimensions and assembling	8

Visual indicators

Generalities	9
References and dimensions	10

- Facia mounted operator
- 3/2 NO or NC
- Pneumatic valves combinable with electrical switches
- Modular construction (up to 3 valves per pushbuttons heads)
- Wide range of actuators

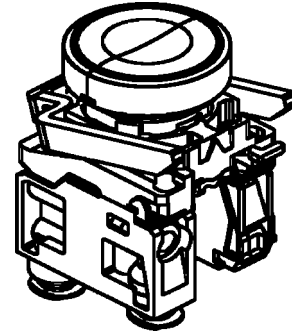

Operating and additional information

Working pressure

PXB-B3•• 1 to 9 bar
 PXB-B4•• 1 to 10 bar

Working temperature -15 °C to +60 °C

Flow

(acc. to ISO 6358)

PXB-B3•• Q_{max}=60 l/min
 Q_n = 30 l/min

PXB-B4•• Q_{max}=200 l/min
 Q_n = 100 l/min

Connections

Ø4 mm straight Push-in as standard
 Ø4 mm swivel Push-in on request
 M5 on request

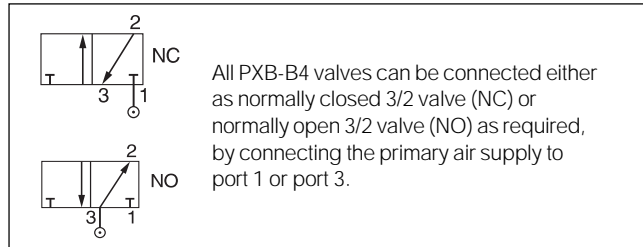

Spring return pushbuttons - Metal head version - Ø 4 mm straight fittings

Symbol	Actuator	Return	Operating force at 6 bar, N	Flow NI/min	Weight kg	Order code
	Pushbutton Black	Spring	8,5 6,0	60 240	0,077 0,082	PXB-B3111BA2 PXB-B4131BA2
	Pushbutton Green	Spring	8,5 6,0	60 240	0,077 0,082	PXB-B3111BA3 PXB-B4131BA3
	Pushbutton Red	Spring	8,5 6,0	60 240	0,077 0,082	PXB-B3111BA4 PXB-B4131BA4
	Pushbutton Black	Spring	16,5 14,0	60 240	0,087 0,092	PXB-B3251BA2 PXB-B4231BA2

Mushroom head pushbuttons - Metal head version - Ø 4 mm straight fittings

Symbol	Actuator	Return	Operating force at 6 bar, N	Flow NI/min	Weight kg	Order code
	Pushbutton Ø40 mm Black	Spring	12 6,5	60 240	0,122 0,127	PXB-B3111BC2 PXB-B4131BC2
	Latching pushbutton Ø40 mm Red		48 42,5	60 240	0,125 0,127	PXB-B3111BT4 PXB-B4131BT4
	Latching pushbutton Ø40 mm Red		49 43,5	60 240	0,125 0,127	PXB-B3121BT4 PXB-B4131BT4

Selector switches - Metal head version - Ø 4 mm straight fittings

Symbol	Actuator	Return	Flow NI/min	Weight kg	Order code
	Latching selector button 2 positions, Black		60	0,092	PXB-B3111BD2
			240	0,097	PXB-B4131BD2
	Latching selector button 2 positions, Black		60	0,102	PXB-B3211BD2
			240	0,107	PXB-B4231BD2
	Latching selector button 2 positions, Black		60	0,102	PXB-B3251BD2
			240	0,107	PXB-B4231BD2
	Latching selector button 3 positions, Black		60	0,102	PXB-B3211BD3
			240	0,107	PXB-B4231BD3
	Latching selector button 3 positions, Black		60	0,102	PXB-B3251BD3
			240	0,107	PXB-B4231BD3
	Non latching selector button with long handle 3 positions, Black	Spring	60	0,103	PXB-B3211BJ5
			240	0,108	PXB-B4231BJ5

Switch bodies with operating metal head mounting - Ø 4 mm straight fittings

For use with ZB4 operating heads

Symbol	Actuator	Return	Operating force at 6 bar, N	Flow NI/min	Weight kg	Order code
	Plunger	Spring	7	60	0,048	PXB-B3111B
			4,5	240	0,053	PXB-B4131B
	Plunger	Spring	8	60	0,048	PXB-B3121B
			4,5	240	0,053	PXB-B4131B

Additional switch valves - Ø 4 mm straight fittings

For use with ZB4 and ZB5 operating heads and mounting blocks

Symbol	Actuator	Return	Operating force at 6 bar, N	Flow NI/min	Weight kg	Order code
	Plunger Straight connection	Spring	7	60	0,010	PXB-B3911
			4,5	240	0,015	PXB-B4931
	Plunger Straight connection	Spring	8	60	0,010	PXB-B3921
			4,5	240	0,015	PXB-B4931
	Plunger Swivel connection	Spring	7	60	0,015	PXB-B3912
			4,5	240	0,021	PXB-B4932
	Plunger Swivel connection	Spring	8	60	0,015	PXB-B3922
			4,5	240	0,021	PXB-B4932

Electrical contact blocks

Connections	Type of contact	Weight kg	Order code
	Normally open (NO) 	0,011	ZBE-101
	Normally closed (NC) 	0,011	ZBE-102

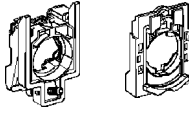

Mounting block for valves and operating heads

Description	For Metal head ZB4		For Plastic head ZB5	
	Weight kg	Order code	Weight kg	Order code
 <p>Mounting block for valves and operating heads:</p> <p>to make up a complete push button with one operating head and switch valves.</p>	0,038	ZB4-BZ009	0,006	ZB5-AZ009

Operating heads

For use with PXB-B3. and PXB-B4. switch bodies

Spring return pushbuttons

Description	Colour	Metal head		Plastic Head	
		Weight kg	Order code	Weight kg	Order code
 <p>Flush</p>	Black	0,029	ZB4-BA2	0,018	ZB5-AA2
	Green	0,029	ZB4-BA3	0,018	ZB5-AA3
	Red	0,029	ZB4-BA4	0,018	ZB5-AA4
	6 color caps	0,029	ZB4-BA9	0,018	ZB5-AA9
 <p>Projecting</p>	Black	0,030	ZB4-BL2	0,019	ZB5-AL2
	Green	0,030	ZB4-BL3	0,019	ZB5-AL3
	Red	0,030	ZB4-BL4	0,019	ZB5-AL4
 <p>Flush booted</p>	Black	0,034	ZB4-BP2		



Push/push pushbuttons

Description	Colour	Metal head	
		Weight kg	Order code
 <p>Flush</p>	Black	0,029	ZB4-BH02
	Green	0,029	ZB4-BH03
	Red	0,029	ZB4-BH04



Double headed spring return pushbuttons

Description	Colour Marking	Metal head	
		Weight kg	Order code
 <p>Flush</p>	Green/Red I/O	0,047	ZB4-BA8234

Mushroom head pushbuttons

Description	Function	Colour	Metal head		Plastic Head	
			Weight kg	Order code	Weight kg	Order code
 <p>Ø40 mm Mushroom head</p>	Spring return	Black	0,074	ZB4-BC2		
		Green	0,074	ZB4-BC3		
		Red	0,074	ZB4-BC4		
	Latching push-pull	Red	0,077	ZB4-BT4		
 <p>Ø60 mm Mushroom head</p>	Spring return	Black	0,093	ZB4-BR2		
 <p>Ø40 mm Mushroom head</p>	Latching Turn to release	Red	0,070	ZB4-BS54	0,044	ZB5-AS54
	Latching Release by Ronis key N° 455	Red	0,070	ZB4-BS14		

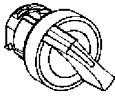
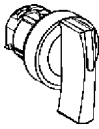
Selector switches

	Description	Function		Metal head		Plastic Head	
				Weight kg	Order code	Weight kg	Order code
	Standard, black handle	2 positions	Stay put	0,044	ZB4-BD2	0,024	ZB5-AD2
		3 positions	Stay put	0,044	ZB4-BD3	0,024	ZB5-AD3
		3 spring return to centre		0,044	ZB4-BD5	0,024	ZB5-AD5
	Long black handle	2 positions	Stay put	0,045	ZB4-BJ2		
		3 positions	Stay put	0,045	ZB4-BJ3		
			Spring return to centre	0,045	ZB4-BJ5		
			1 spring return from left to centre	0,045	ZB4-BJ7		
	Key operated (Ronis N° 455)	2 stay put positions	Left	0,069	ZB4-BG2		
			Left and right	0,069	ZB4-BG4		

Tools

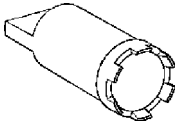
Description	Weight kg	Order code
 ZB5 head nut tools	0,160	ZB5-AZ905

PXB-B3

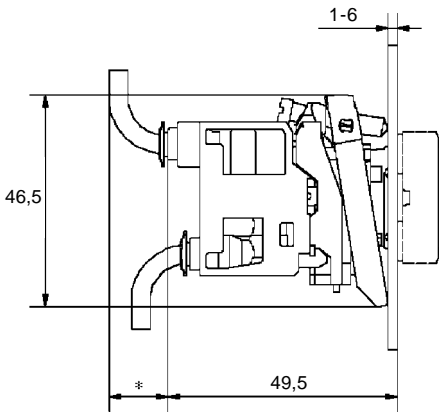

Body width 30 mm
 * With 2 x 4 mm tube = 10
 With 2,7 x 4 mm tube = 15

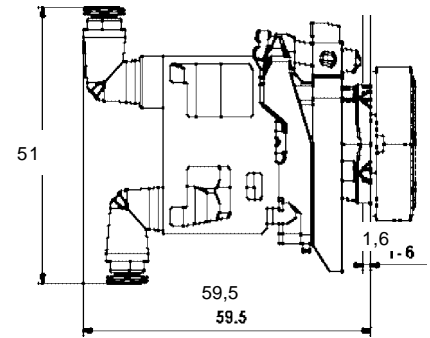
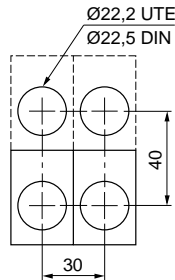

PXB-B4

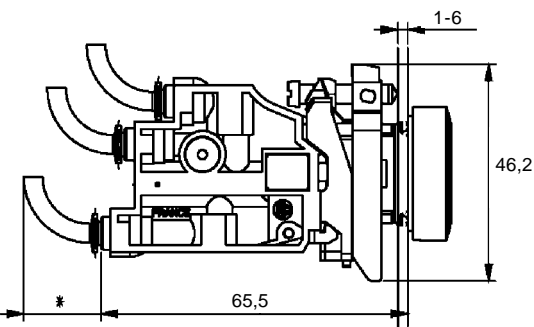

Body width 30 mm
 * With 2 x 4 mm tube = 10
 With 2,7 x 4 mm tube = 15

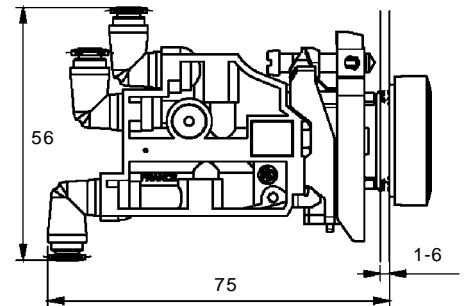

Assembling of PXB-B3. and PXB-B4. valves on mounting block

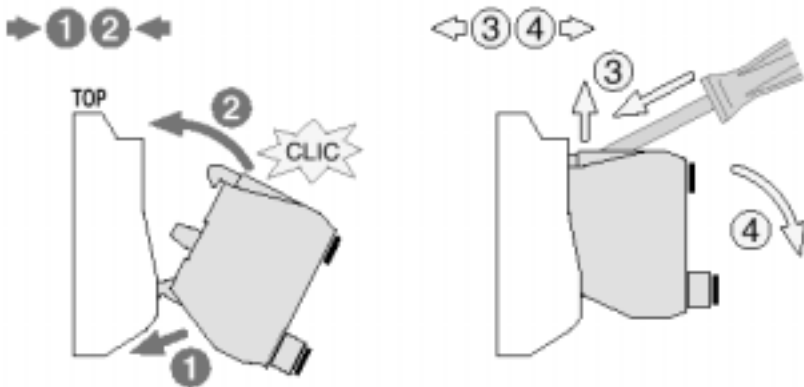

Assembling of PXB-B3. and PXB-B4. valves on the back of the electrical contact

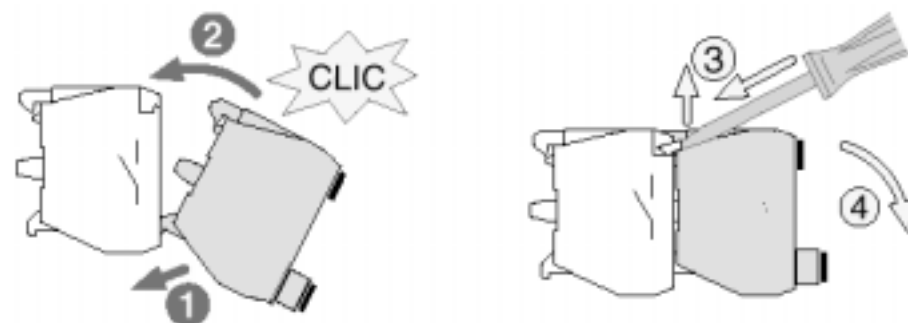

- Lightning fast response
- Simple long life mechanism
- Very high contrast
- All around visibility
- One single pipe connection
- Effective aid to diagnostics

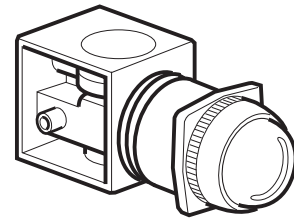

Operating information

Working pressure 1-8 bar
 Working temperature -15 °C to +60 °C

Options and additional information

Connections Ø4 mm straight Push-in
 as standard

Order key

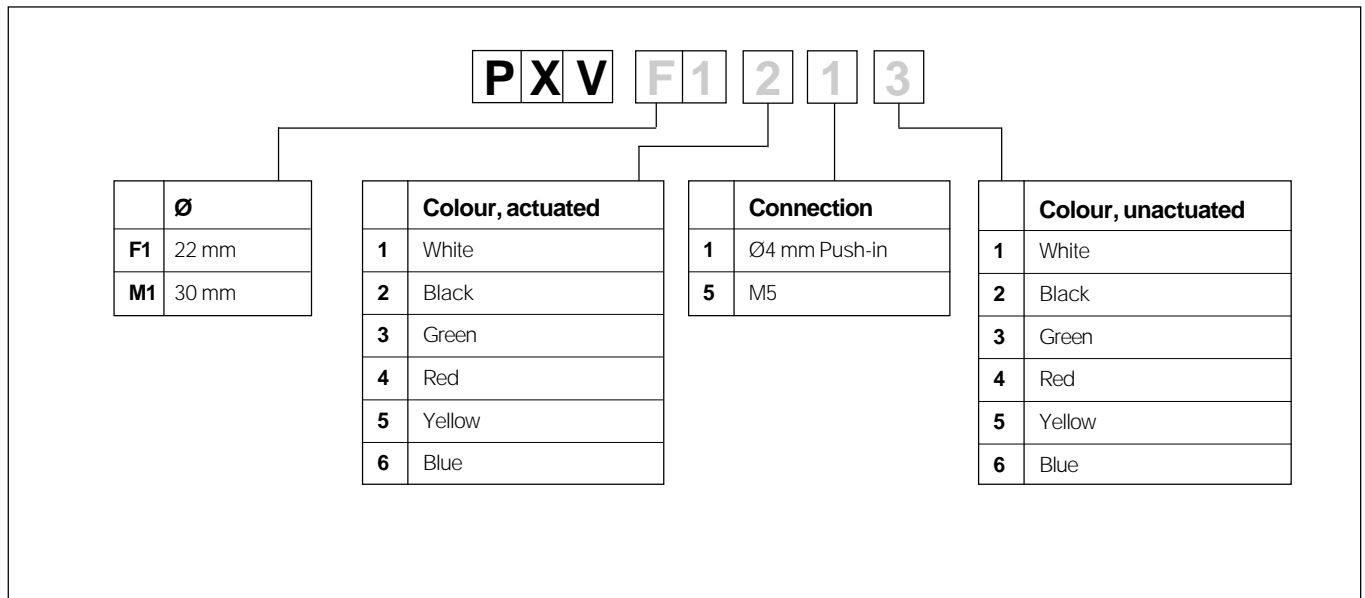

Ø22 mm Visual Indicators

**Black plastic bezel
In the actuated mode**

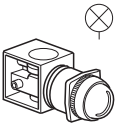
Symbol	Colour *	Weight kg	Order code
	Green	0,080	PXV-F131
	Red	0,080	PXV-F141
	Yellow	0,080	PXV-F151
	Blue	0,080	PXV-F161
	White	0,080	PXV-F111

Ø22 mm Visual Indicators

**Black plastic bezel
In the unactuated mode**

Symbol	Colour *	Weight kg	Order code
	Green	0,080	PXV-F1213
	Red	0,080	PXV-F1214
	Yellow	0,080	PXV-F1215
	Blue	0,080	PXV-F1216
	White	0,080	PXV-F1211

* The pneumatic indicators are black in one position and coloured in the other.
The coloured position corresponds either to the presence of pressure (actuated mode) or the absence of pressure (unactuated mode). For two different colours on the same indicator, please consult Technical Sales Department

Ø22 mm visual indicators

PXV-F1**

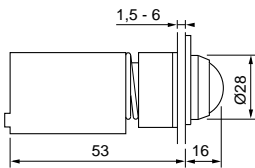

Minimum distance between centres

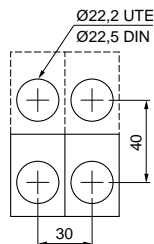

Parker Worldwide

AE – UAE, Dubai
Tel: +971 4 8127100
parker.me@parker.com

AR – Argentina, Buenos Aires
Tel: +54 3327 44 4129

AT – Austria, Wiener Neustadt
Tel: +43 (0)2622 23501-0
parker.austria@parker.com

AT – Eastern Europe, Wiener Neustadt
Tel: +43 (0)2622 23501 900
parker.easteurope@parker.com

AU – Australia, Castle Hill
Tel: +61 (0)2-9634 7777

AZ – Azerbaijan, Baku
Tel: +994 50 2233 458
parker.azerbaijan@parker.com

BE/LU – Belgium, Nivelles
Tel: +32 (0)67 280 900
parker.belgium@parker.com

BR – Brazil, Cachoeirinha RS
Tel: +55 51 3470 9144

BY – Belarus, Minsk
Tel: +375 17 209 9399
parker.belarus@parker.com

CA – Canada, Milton, Ontario
Tel: +1 905 693 3000

CH – Switzerland, Etoy
Tel: +41 (0) 21 821 02 30
parker.switzerland@parker.com

CL – Chile, Santiago
Tel: +56 2 623 1216

CN – China, Shanghai
Tel: +86 21 2899 5000

CZ – Czech Republic, Klecany
Tel: +420 284 083 111
parker.czechrepublic@parker.com

DE – Germany, Kaarst
Tel: +49 (0)2131 4016 0
parker.germany@parker.com

DK – Denmark, Ballerup
Tel: +45 43 56 04 00
parker.denmark@parker.com

ES – Spain, Madrid
Tel: +34 902 330 001
parker.spain@parker.com

FI – Finland, Vantaa
Tel: +358 (0)20 753 2500
parker.finland@parker.com

FR – France, Contamine s/Arve
Tel: +33 (0)4 50 25 80 25
parker.france@parker.com

GR – Greece, Athens
Tel: +30 210 933 6450
parker.greece@parker.com

HK – Hong Kong
Tel: +852 2428 8008

HU – Hungary, Budapest
Tel: +36 1 220 4155
parker.hungary@parker.com

IE – Ireland, Dublin
Tel: +353 (0)1 466 6370
parker.ireland@parker.com

IN – India, Mumbai
Tel: +91 22 6513 7081-85

IT – Italy, Corsico (MI)
Tel: +39 02 45 19 21
parker.italy@parker.com

JP – Japan, Tokyo
Tel: +(81) 3 6408 3901

KR – South Korea, Seoul
Tel: +82 2 559 0400

KZ – Kazakhstan, Almaty
Tel: +7 7272 505 800
parker.easteurope@parker.com

LV – Latvia, Riga
Tel: +371 6 745 2601
parker.latvia@parker.com

MX – Mexico, Apodaca
Tel: +52 81 8156 6000

MY – Malaysia, Shah Alam
Tel: +60 3 7849 0800

NL – The Netherlands, Oldenzaal
Tel: +31 (0)541 585 000
parker.nl@parker.com

NO – Norway, Ski
Tel: +47 64 91 10 00
parker.norway@parker.com

NZ – New Zealand, Mt Wellington
Tel: +64 9 574 1744

PL – Poland, Warsaw
Tel: +48 (0)22 573 24 00
parker.poland@parker.com

PT – Portugal, Leca da Palmeira
Tel: +351 22 999 7360
parker.portugal@parker.com

RO – Romania, Bucharest
Tel: +40 21 252 1382
parker.romania@parker.com

RU – Russia, Moscow
Tel: +7 495 645-2156
parker.russia@parker.com

SE – Sweden, Spånga
Tel: +46 (0)8 59 79 50 00
parker.sweden@parker.com

SG – Singapore
Tel: +65 6887 6300

SK – Slovakia, Banská Bystrica
Tel: +421 484 162 252
parker.slovakia@parker.com

SL – Slovenia, Novo Mesto
Tel: +386 7 337 6650
parker.slovenia@parker.com

TH – Thailand, Bangkok
Tel: +662 717 8140

TR – Turkey, Istanbul
Tel: +90 216 4997081
parker.turkey@parker.com

TW – Taiwan, Taipei
Tel: +886 2 2298 8987

UA – Ukraine, Kiev
Tel: +380 44 494 2731
parker.ukraine@parker.com

UK – United Kingdom, Warwick
Tel: +44 (0)1926 317 878
parker.uk@parker.com

US – USA, Cleveland
Tel: +1 216 896 3000

VE – Venezuela, Caracas
Tel: +58 212 238 5422

ZA – South Africa, Kempton Park
Tel: +27 (0)11 961 0700
parker.southafrica@parker.com

European Product Information Centre
Free phone: 00 800 27 27 5374
(from AT, BE, CH, CZ, DE, DK, EE, ES, FI, FR, IE, IL, IS, IT, LU, MT, NL, NO, PL, PT, RU, SE, UK, ZA)

