



aerospace
climate control
electromechanical
filtration
fluid & gas handling
hydraulics
pneumatics
process control
sealing & shielding



Stainless steel Pneumatic cylinders

Series P1S
According to ISO

Catalogue PDE2535TCUK April 2012



ENGINEERING YOUR SUCCESS.

Contents	Page
Stainless steel cylinders, general information.....	3
Guide for selecting suitable tubing	5
P1S-S, ISO 6432, Ø10-Ø25	7
Main data	7
Cylinder forces.....	7
Cushioning diagram.....	8
Material specification	8
Stroke length.....	9
Order key	9
Dimensions	10
Mountings	11-12
P1S- ISO 6431, Ø32-Ø125	13
Main data	13
Cylinder forces.....	13
Cushioning diagram.....	13
Introduction to the ATEX directive	14 - 17
Stroke length.....	18
Order key	18
Dimensions Ø32-Ø63.....	19
Material specification Ø32-Ø63.....	19
Dimensions Ø80-Ø125.....	20
Material specification Ø80-Ø125.....	20
Mountings	21-24
Sensors.....	25-28
Connecting cables with one connector	29
Male connectors for connecting cables.....	29
Ready to use connecting cables with connectors at each end	29
Connection block Valvetronic 110.....	30
Seal kits for P1S cylinders.....	31
Grease	31



Important

Before attempting any external or internal work on the cylinder or any connected components, make sure the cylinder is vented and disconnect the air supply in order to ensure isolation of the air supply.



Note

All technical data in this catalogue are typical data only.
Air quality is essential for maximum cylinder service life (see ISO 8573).

 **WARNING**

FAILURE OR IMPROPER SELECTION OR IMPROPER USE OF THE PRODUCTS AND/OR SYSTEMS DESCRIBED HEREIN OR RELATED ITEMS CAN CAUSE DEATH, PERSONAL INJURY AND PROPERTY DAMAGE.

This document and other information from Parker Hannifin Corporation, its subsidiaries and authorized distributors provide product and/or system options for further investigation by users having technical expertise. It is important that you analyze all aspects of your application and review the information concerning the product or system in the current product catalog. Due to the variety of operating conditions and applications for these products or systems, the user, through its own analysis and testing, is solely responsible for making the final selection of the products and systems and assuring that all performance, safety and warning requirements of the application are met. The products described herein, including without limitation, product features, specifications, designs, availability and pricing, are subject to change by Parker Hannifin Corporation and its subsidiaries at any time without notice.

SALE CONDITIONS

The items described in this document are available for sale by Parker Hannifin Corporation, its subsidiaries or its authorized distributors. Any sale contract entered into by Parker will be governed by the provisions stated in Parker's standard terms and conditions of sale (copy available upon request).

P1S Series Stainless Steel Pneumatic Cylinders

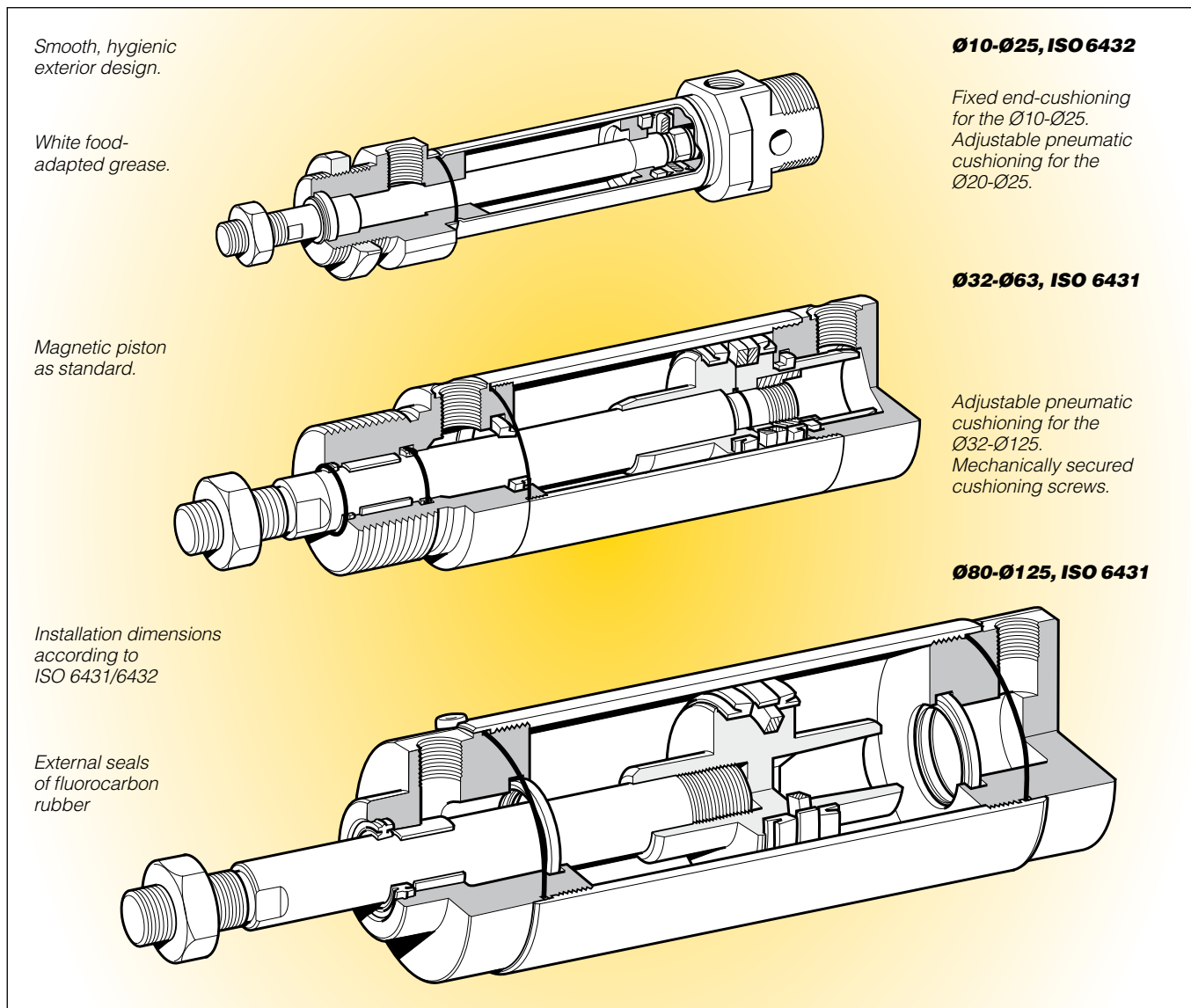

Smooth, hygienic exterior design.

White food-adapted grease.

Magnetic piston as standard.

Installation dimensions according to ISO 6431/6432

External seals of fluorocarbon rubber

Ø10-Ø25, ISO 6432

Fixed end-cushioning for the Ø10-Ø25. Adjustable pneumatic cushioning for the Ø20-Ø25.

Ø32-Ø63, ISO 6431

Adjustable pneumatic cushioning for the Ø32-Ø125. Mechanically secured cushioning screws.

Ø80-Ø125, ISO 6431

Stainless steel cylinders

Parker Pneumatic's range of stainless steel cylinders has been specially designed for use in difficult environments. Hygienic design, external seals of fluorinated rubber and prelubrication with our food-industry-approved grease according to USDA-H1 make the cylinders particularly suitable for food industry use.

All cylinders have magnetic pistons for proximity position sensing. Fixing dimensions to ISO 6431/6432 simplify installation and make the cylinders physically interchangeable throughout the world.

ISO 6432

The cylinders are available in two versions. One with fixed end-cushioning and is available in 10, 12, 16, 20 and 25 mm diameters. A single-acting version with spring return in the negative direction, is available in the same diameters.

One version has adjustable pneumatic end-cushioning and is available in 20 and 25 mm diameters.

ISO 6431-cylinders

The ISO cylinders are double-acting round cylinders with several types of cylinder mountings as standard. The cylinders are available in 32 to 125 mm diameters, incorporating adjustable end-cushioning. As with the ISO 6432 it is designed to comply with hygiene requirements in accordance with the EU Machine Directive.

The cylinder can be dismantled to facilitate service and maintenance.



P1S Series Stainless Steel Pneumatic Cylinders

Stainless steel construction

The cylinders are made for use in particularly demanding environments. The piston rod, cylinder tube and end covers are all of stainless steel.

Effective end-cushioning

A version of ISO 6432 $\varnothing 10$ - $\varnothing 25$ incorporates fixed end-cushioning, while the cylinders $\varnothing 20$ - $\varnothing 125$ have pneumatic end-cushioning with adjusting screws for exact setting, permitting heavier loads and higher speeds for short cycle times.

Smooth external design

The end covers have no recesses or other grooves that could collect dirt or liquid. Cleaning is easy and effective.

Dry operation

Particular attention has been paid to the design of the cylinders' scraper rings, piston rod bearings and piston rod seals. Self-lubricating materials permit regular washing/degreasing of the piston rod. This is important in applications where hygiene and cleaning must be of high standard.

Proximity position sensing

All cylinders in normal temperature design are fitted with a magnet for proximity position sensing. Electronic type sensors and reed switches are available. They are supplied with either flying lead or cable plug connector.

Complete range of mountings

A complete range of stainless steel mounting accessories with ISO dimensions is available.

Variants

In addition to the basic design, several standard variants of these stainless steel cylinders are available to fulfill more demanding requirements in terms of performance and environmental conditions:

- Cylinders with special stroke lengths
- Cylinders with extended piston rods
- Through piston rods (not $\varnothing 32$ - $\varnothing 63$)
- Single-acting cylinders with spring return, ($\varnothing 10$ - $\varnothing 25$)
- High-temperature versions for operation in temperature range $\varnothing 10$ to $\varnothing 16$ mm from -10 °C to $+120$ °C (not magnetic pistons)
- $\varnothing 20$ to $\varnothing 125$ mm from -10 °C to $+150$ °C (not magnetic pistons)
- Low-temperature versions for operation in temperature range from -40 °C to $+60$ °C (not magnetic pistons, not $\varnothing 32$ - $\varnothing 63$)
- Cylinders with different mounts ($\varnothing 32$ - $\varnothing 125$)

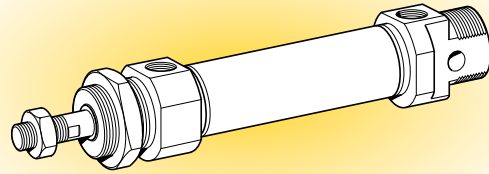

Double acting $\varnothing 10$ - $\varnothing 25$, fixed end-cushioning

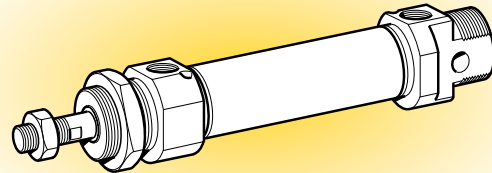

Double acting $\varnothing 20$ - $\varnothing 25$, adjustable end-cushioning

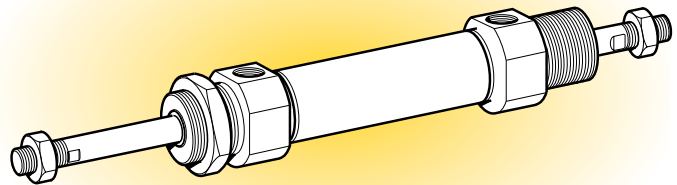

Double acting $\varnothing 10$ - $\varnothing 25$, through piston rod

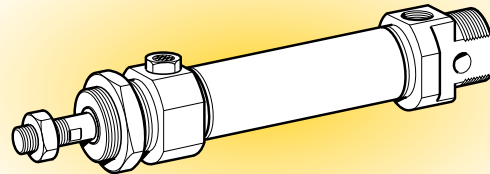

Single acting $\varnothing 10$ - $\varnothing 25$, spring return

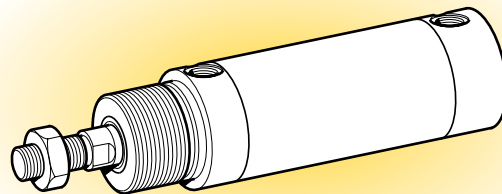

Double acting $\varnothing 32$ - $\varnothing 63$

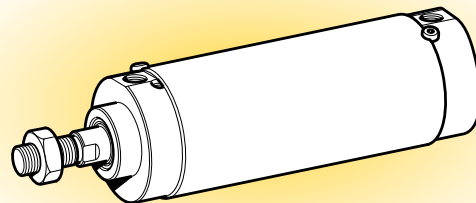

Double acting $\varnothing 80$ - $\varnothing 125$

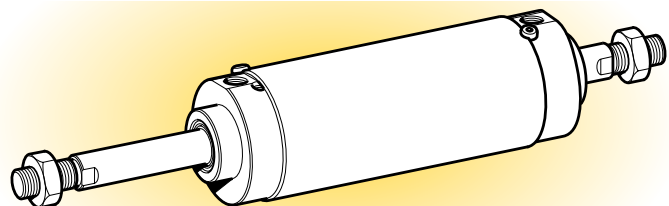

Double acting $\varnothing 80$ - $\varnothing 125$, through piston rod

Guide for selecting suitable tubing

The selection of the correct size of tubing is often based on experience, with no great thought to optimizing energy efficiency and cylinder velocity. This is usually acceptable, but making a rough calculation can result in worthwhile economic gains.

The following is the basic principle:

1. The primary line to the working valve could be over sized (this does not cause any extra air consumption and consequently does not create any extra costs in operation).
2. The tubes between the valve and the cylinder should, however, be optimized according to the principle that an insufficient bore throttles the flow and thus limits the cylinder speed, while an oversized pipe creates a dead volume which increases the air consumption and filling time.

The chart below is intended to help when selecting the correct size of tube to use between the valve and the cylinder.

The following prerequisites apply:

The *cylinder load should be about 50%* of the theoretical force (= normal load). A lower load gives a higher velocity and vice versa. The tube size is selected as a function of the *cylinder bore*, the desired *cylinder velocity* and the *tube length* between the valve and the cylinder.

If you want to use the capacity of the valve to its maximum, and obtain maximum speed, the tubing should be chosen so that they at least correspond with the equivalent restriction diameter (see description below), so that the tubing does not restrict the total flow. This means that a short tubing must have at least the equivalent restriction diameter. If the tubing is longer, choose it from the table below. Straight fittings should be chosen for highest flow rates. (Elbow and banjo fittings cause restriction.)

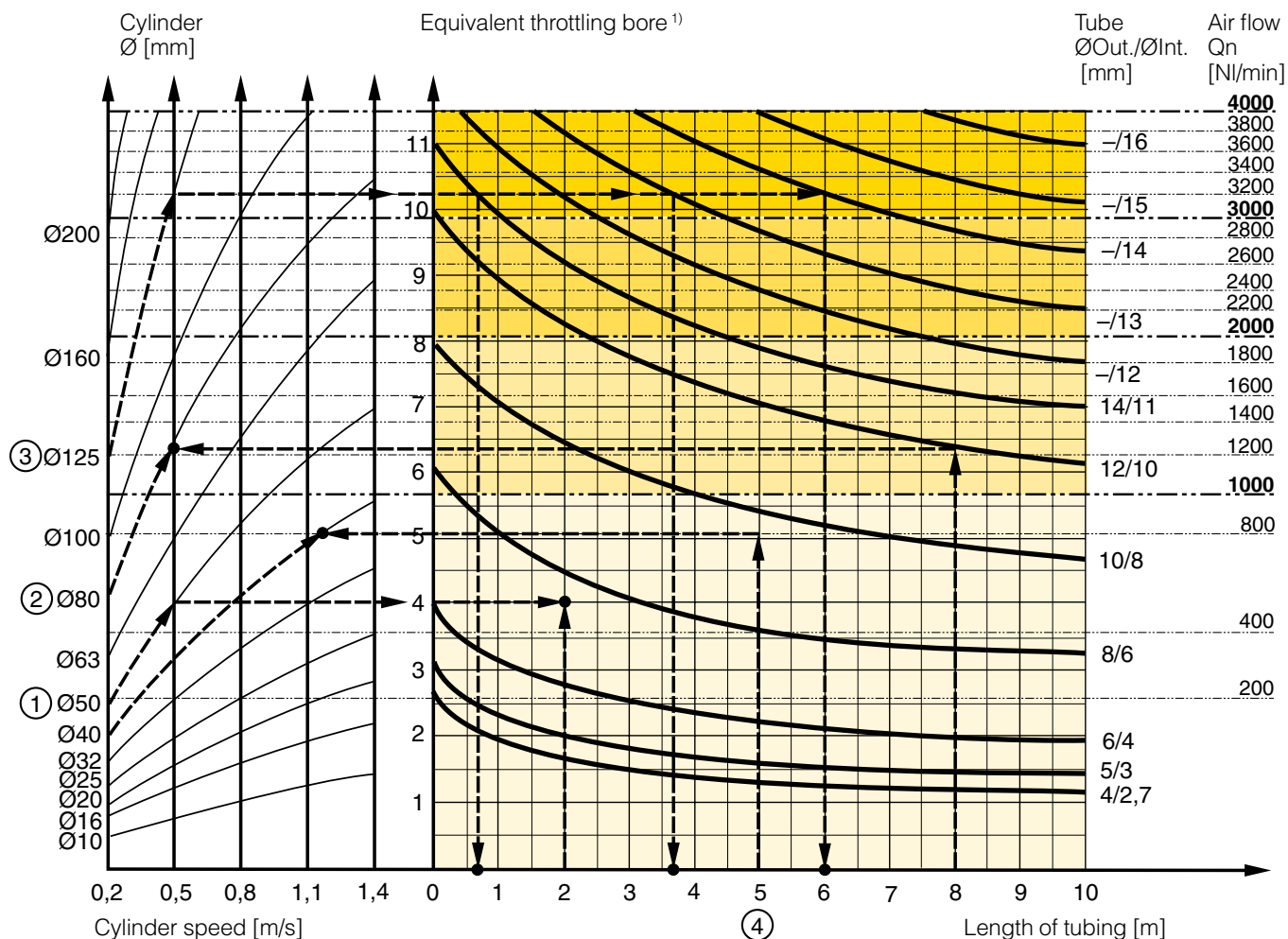

- 1) The "equivalent throttling bore" is a long throttle (for example a tube) or a series of throttles (for example, through a valve) converted to a short throttle which gives a corresponding flow rate. This should not be confused with the "orifice" which is sometimes specified for valves. The value for the orifice does not normally take account of the fact that the valve contains a number of throttles.
- 2) Qn is a measure of the valve flow capacity, with flow measured in litre per minute (l/min) at 6 bar(e) supply pressure and 1 bar pressure drop across the valve.

P1S Series Stainless Steel Pneumatic Cylinders

Example ①: Which tube diameter should be used?

A 50 mm bore cylinder is to be operated at 0.5 m/s. The tube length between the valve and cylinder is 2 m. In the diagram we follow the line from 50 mm bore to 0.5 m/s and get an “equivalent throttling bore” of approximately 4 mm. We continue out to the right in the chart and intersect the line for a 2 m tube between the curves for 4 mm (6/4 tube) and 6 mm (8/6 tube). This means that a 6/4 tube throttles the velocity somewhat, while an 8/6 tube is a little too large. We select the 8/6 tube to obtain full cylinder velocity.

Example ②: What cylinder velocity will be obtained?

A 80 mm bore cylinder will be used, connected by 8 m 12/10 tube to a valve with Qn 1200 NI/min. What cylinder velocity will we get? We refer to the diagram and follow the line from 8 mm tube length up to the curve for 12/10 tube. From there, we go horizontally to the curve for the Ø80 cylinder. We find that the velocity will be about 0.5 m/s.

Example ③: What is the minimum inner diameter and maximum length of tube?

For an application a 125 mm bore cylinder will be used. Maximum velocity of piston rod is 0.5 m/s. The cylinder will be controlled by a valve with Qn 3200 NI/min. What diameter of tube can be used and what is maximum length of tube. We refer to the diagram. We start at the left side of the diagram cylinder Ø125. We follow the line until the intersection with the velocity line of 0.5 m/s. From here we draw a horizontal line in the diagram. This line shows us we need an equivalent throttling bore of approximately 10 mm. Following this line horizontally we cross a few intersections. These intersections shows us the minimum inner diameter (rightside diagram) in combination with the maximum length of tube (bottomside diagram).

For example:

Intersection one: When a tube (14/11) will be used, the maximum length of tube is 0.7 meter.

Intersection two: When a tube (—/13) will be used, the maximum length of tube is 3.7 meter.

Intersection three: When a tube (—/14) will be used, the maximum length of tube is 6 meter.

Example ④: Determining tube size and cylinder velocity with a particular cylinder and valve?

For an application using a 40 mm bore cylinder with a valve with Qn=800 NI/min. The distance between the cylinder and valve has been set to 5 m.

Tube dimension: What tube bore should be selected to obtain the maximum cylinder velocity? Start at pipe length 5 m, follow the line up to the intersection with 800 NI/min. Select the next largest tube diameter, in this case Ø10/8 mm.

Cylinder velocity: What maximum cylinder velocity will be obtained? Follow the line for 800 NI/min to the left until it intersects with the line for the Ø40 mm cylinder. In this example, the speed is just above 1.1 m/s.

Valve series with respective flows in NI/minute

Valve series	Qn in NI/Min
Valvetronic Solstar	33
Interface PS1	100
Adex A05	173
Moduflex size 1, (2 x 3/2)	220
Valvetronic PVL-B 5/3 closed centre, 6 mm push in	290
Moduflex size 1, (4/2)	320
B43 Manual and mechanical	340
Valvetronic PVL-B 2 x 2/3, 6 mm push in	350
Valvetronic PVL-B 5/3 closed centre, G1/8	370
Compact Isomax DX02	385
Valvetronic PVL-B 2 x 3/2 G1/8	440
Valvetronic PVL-B 5/2, 6 mm push in	450
Valvetronic PVL-B 5/3 vented centre, 6 mm push in	450
Moduflex size 2, (2 x 3/2)	450
Flowstar P2V-A	520
Valvetronic PVL-B 5/3 vented centre, G1/8	540
Valvetronic PVL-B 5/2, G1/8	540
Valvetronic PVL-C 2 x 3/2, 8 mm push in	540
Adex A12	560
Valvetronic PVL-C 2 x 3/2 G1/8	570
Compact Isomax DX01	585
VIKING Xtreme P2LAX	660
Valvetronic PVL-C 5/3 closed centre, 8 mm push in	700
Valvetronic PVL-C 5/3 vented centre, G1/4	700
B3-Series	780
Valvetronic PVL-C 5/3 closed centre, G1/4	780
Moduflex size 2, (4/2)	800
Valvetronic PVL-C 5/2, 8 mm push in	840
Valvetronic PVL-C 5/3 vented centre, 8 mm push in	840
Valvetronic PVL-C 5/2, G1/4	840
Flowstar P2V-B	1090
ISOMAX DX1	1150
B53 Manual and mechanical	1160
B4-Series	1170
VIKING Xtreme P2LBX	1290
B5-Series, G1/4	1440
Airline Isolator Valve VE22/23	1470
ISOMAX DX2	2330
VIKING Xtreme P2LCX, G3/8	2460
VIKING Xtreme P2LDX, G1/2	2660
ISOMAX DX3	4050
Airline Isolator Valve VE42/43	5520
Airline Isolator Valve VE82/83	13680

Main data: P1S-S, ISO 6432

Cylinder designation	Cylinder bore		Piston rod bore		thread	Total mass		Air consumption	Port thread
	mm	cm ²	mm	cm ²		at 0 mm stroke	addition per 10 mm stroke		
	mm	cm ²	mm	cm ²		kg	kg	litres	
Double acting with fixed end-cushioning									
P1S-S010D	10	0,78	4	0,13	M4	0,04	0,003	0,0100 ¹⁾	M5
P1S-S012D	12	1,13	6	0,28	M6	0,07	0,004	0,0139 ¹⁾	M5
P1S-S016D	16	2,01	6	0,28	M6	0,09	0,005	0,0262 ¹⁾	M5
P1S-S020D	20	3,14	8	0,50	M8	0,18	0,007	0,0405 ¹⁾	G1/8
P1S-S025D	25	4,91	10	0,78	M10x1,25	0,25	0,011	0,0633 ¹⁾	G1/8
Double acting with adjustable end-cushioning									
P1S-S020M	20	3,14	8	0,50	M8	0,18	0,007	0,0405 ¹⁾	G1/8
P1S-S025M	25	4,91	10	0,78	M10x1,25	0,25	0,011	0,0633 ¹⁾	G1/8
Single acting:									
P1S-S010SS	10	0,78	4	0,13	M4	0,04	0,003	0,0055 ¹⁾	M5
P1S-S012SS	12	1,13	6	0,28	M6	0,08	0,004	0,0079 ¹⁾	M5
P1S-S016SS	16	2,01	6	0,28	M6	0,10	0,005	0,0141 ¹⁾	M5
P1S-S020SS	20	3,14	8	0,50	M8	0,18	0,007	0,0220 ¹⁾	G1/8
P1S-S025SS	25	4,91	10	0,78	M10x1,25	0,26	0,011	0,0344 ¹⁾	G1/8

1) Free air consumption per 10 mm stroke length for a double stroke at 600 kPa (6 bar)

Cylinder forces

Indicated cylinder forces are theoretical and should be reduced according to the working conditions.

Cylinder designation	Cylinder bore	Theoretical cylinder force at 600 kPa (6 bar)		Cylinder designation	Theoretical cylinder force at 600 kPa (6 bar)			
		exp. stroke	retraction stroke		expanding stroke	spring retraction	Nmax	Nmin
	mm	N	N		Nmax	Nmin	Nmax	Nmin
Double acting				Single acting				
P1S-S010D	10	47	39	P1S-S010SS-0010	38	36	11	9
P1S-S012D	12	67	50	P1S-S010SS-0015	38	36	11	9
P1S-S016D	16	120	103	P1S-S010SS-0025	39	36	11	8
P1S-S020D	20	188	158	P1S-S010SS-0040	38	34	13	9
P1S-S025D	25	294	247	P1S-S010SS-0050	39	34	13	8
				P1S-S010SS-0080	39	34	13	8
P1S-S020M	20	188	158	P1S-S012SS-0010	53	51	16	14
P1S-S025M	25	294	247	P1S-S012SS-0015	53	51	16	14
				P1S-S012SS-0025	55	51	16	12
				P1S-S012SS-0040	52	48	19	15
				P1S-S012SS-0050	53	48	19	14
				P1S-S012SS-0080	55	48	19	12
				P1S-S016SS-0010	102	99	21	18
				P1S-S016SS-0015	103	99	21	17
				P1S-S016SS-0025	105	99	21	15
				P1S-S016SS-0040	106	95	25	14
				P1S-S016SS-0050	108	95	25	12
				P1S-S016SS-0080	107	95	25	13
				P1S-S020SS-0010	163	161	27	25
				P1S-S020SS-0015	164	161	27	24
				P1S-S020SS-0025	167	161	27	21
				P1S-S020SS-0040	166	159	29	22
				P1S-S020SS-0050	168	159	29	20
				P1S-S020SS-0080	170	161	27	18
				P1S-S025SS-0010	256	253	41	38
				P1S-S025SS-0015	258	253	41	36
				P1S-S025SS-0025	262	253	41	32
				P1S-S025SS-0040	261	250	44	33
				P1S-S025SS-0050	264	250	44	30
				P1S-S025SS-0080	264	251	43	30

Additional data

Working pressure max 1000 kPa (10 bar)

Working temperature max +80 °C
min -20 °C

High-temperature version max +120 °C (Ø10 - Ø 16 mm)
max +150 °C (Ø20 - Ø 25 mm)
min -10 °C

Low-temperature version max +60 °C
min -40 °C

Pre-lubricated, further lubrication is not normally necessary. If additional lubrication is introduced it must be continued.

Cushioning diagram

Use the diagram below to determine the necessary size of cylinder to provide the requisite cushioning performance. The maximum cushioning performance, as indicated in the diagram, is based on the following assumptions:

- Low load, i.e. low pressure drop across the piston
- Steady-state piston speed
- Correctly adjusted cushioning screw

The load is the sum of the internal and external friction, together with any gravity forces. At high relative loading it is recommended that, for a given speed, the load should be reduced by a factor of 2.5, or that, for a given mass, the speed should be reduced by a factor of 1.5. These factors apply in relation to the maximum performance as shown in the diagram.

Fixed end-cushioning

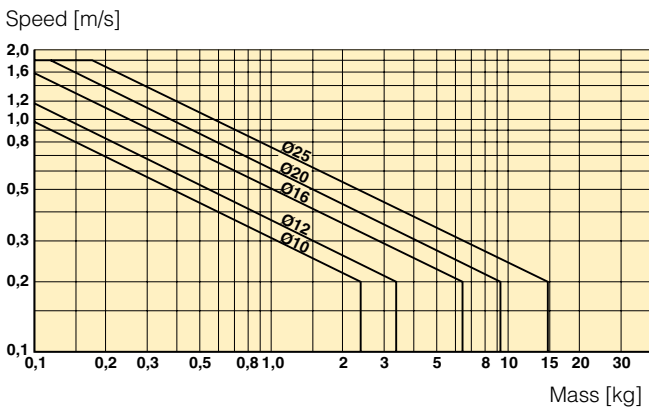

Adjustable pneumatic end-cushioning

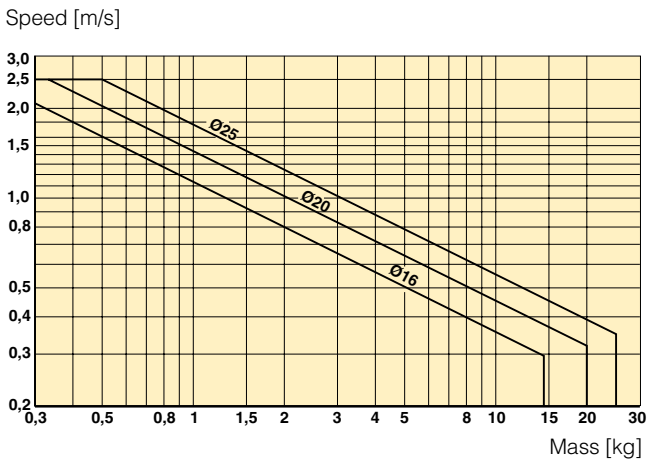

Material specification Ø10-Ø25

Piston rod	Stainless steel, DIN X 10 CrNiS 18 9
Piston rod seal	Fluorocarbon rubber FPM
Piston rod bearing	Multilayer PTFE/steel
End covers	Stainless steel, DIN X 10 CrNiS 18 9
O-ring, internal	NBR
Cylinder barrel	Stainless steel, DIN X 5 CrNi 18 10
Piston, complete	NBR/steel
Magnet holder	Thermoplastic elastomer
Magnet	Plastic-coated magnetic material
Return spring	Surface-treated steel
Cushioning screw	Stainless steel, DIN X 10 CrNiS 18 9

Variants Ø10-Ø25:

Low-temperature version, type L

Piston rod seal	NBR
Piston, complete	NBR/steel

High-temperature version, type F

Piston rod seal	Fluorocarbon rubber, FPM
Piston complete, Ø10-Ø16	HNBR/steel
Piston complete, Ø20-Ø25	FPM/steel

Working medium, air quality

Working medium Dry, filtered compressed air
 to ISO 8573-1 class 3.4.3.

Recommended air quality for cylinders







For best possible service life and trouble-free operation, ISO 8573-1 quality class 3.4.3 should be used. This means 5 µm filter (standard filter) dew point +3 °C for indoor operation (a lower dew point should be selected for outdoor operation) and oil concentration 1.0 mg oil/m³, which is what a standard compressor with a standard filter gives.

ISO 8573-1 quality classes



Quality class	Pollution particle size (µm)	max concentration (mg/m ³)	Water max. press. dew point (°C)	Oil max concentration (mg/m ³)
1	0,1	0,1	-70	0,01
2	1	1	-40	0,1
3	5	5	-20	1,0
4	15	8	+3	5,0
5	40	10	+7	25
6	-	-	+10	-

Order key

P1S - S **016** **M** **S** - **0025**

Cylinder bore mm	Cylinder type/Function	Stroke in mm
010	M  Double acting, adjustable cushioning Ø20 - Ø25 Not for sealing material type F and L	E.g. 0025 = 25 mm For standard stroke length and max length, see table below
012	D  Double acting, fixed cushioning Ø10 - Ø25	
016	F  Double acting, adjustable cushioning, through piston rod, Ø20 - Ø25 Not for sealing material type F and L	
020	K  Double acting, fixed cushioning, through piston rod, Ø10 - Ø25	
025	H  Double acting, adjustable cushioning, through piston rod (hollow), Ø20 - Ø25, max stroke 125 mm Not for sealing material type F and L	
	P  Double acting, fixed cushioning, through piston rod (hollow), Ø20 - Ø25, max stroke 125 mm	
	S  Single acting, fixed cushioning, spring return for retract stroke, Ø10 - Ø25	

Cylinder version	
S	Standard cylinder acc. to Cylinder type/Function

Sealing material	
S	Standard, -20 °C to +80 °C Magnetic piston
F 	High temperature, -10 °C to +120 °C Ø10 - Ø16 mm -10 °C to +150 °C Ø20 - Ø25 mm Non magnetic piston
L 	Low temperature, -40 °C to +60 °C Non magnetic piston

Stroke length

Cylinder designation	Cylinder bore	● Standard stroke length in mm										■ Non standard stroke length					
		10	15	20	25*	30	40	50*	80*	100*	125*	160*	200*	250*	320*	400*	500*
Double acting with fixed end-cushioning:																	
P1S-S 010 D	10	●	●	●	●	●	●	●	●	●	●	●	●	●	●	●	●
P1S-S 012 D	12	●	●	●	●	●	●	●	●	●	●	●	●	●	●	●	●
P1S-S 016 D	16	●	●	●	●	●	●	●	●	●	●	●	●	●	●	●	●
P1S-S 020 D	20	●	●	●	●	●	●	●	●	●	●	●	●	●	●	●	●
P1S-S 025 D	25	●	●	●	●	●	●	●	●	●	●	●	●	●	●	●	●
Double acting with adjustable end-cushioning:																	
P1S-S 020 M	20			●	●	●	●	●	●	●	●	●	●	●	●	●	●
P1S-S 025 M	25			●	●	●	●	●	●	●	●	●	●	●	●	●	●
Single acting:																	
P1S-S 010 SS	10	●	●	●	●	●	●	●	●	●	●	●	●	●	●	●	●
P1S-S 012 SS	12	●	●	●	●	●	●	●	●	●	●	●	●	●	●	●	●
P1S-S 016 SS	16	●	●	●	●	●	●	●	●	●	●	●	●	●	●	●	●
P1S-S 020 SS	20	●	●	●	●	●	●	●	●	●	●	●	●	●	●	●	●
P1S-S 025 SS	25	●	●	●	●	●	●	●	●	●	●	●	●	●	●	●	●

*Standard stroke length in mm according to ISO 4393

CAD drawings on the Internet

Our home page www.parker.com/euro_pneumatic includes the Cad Drawing Library with 2D and 3D drawings for the main versions.

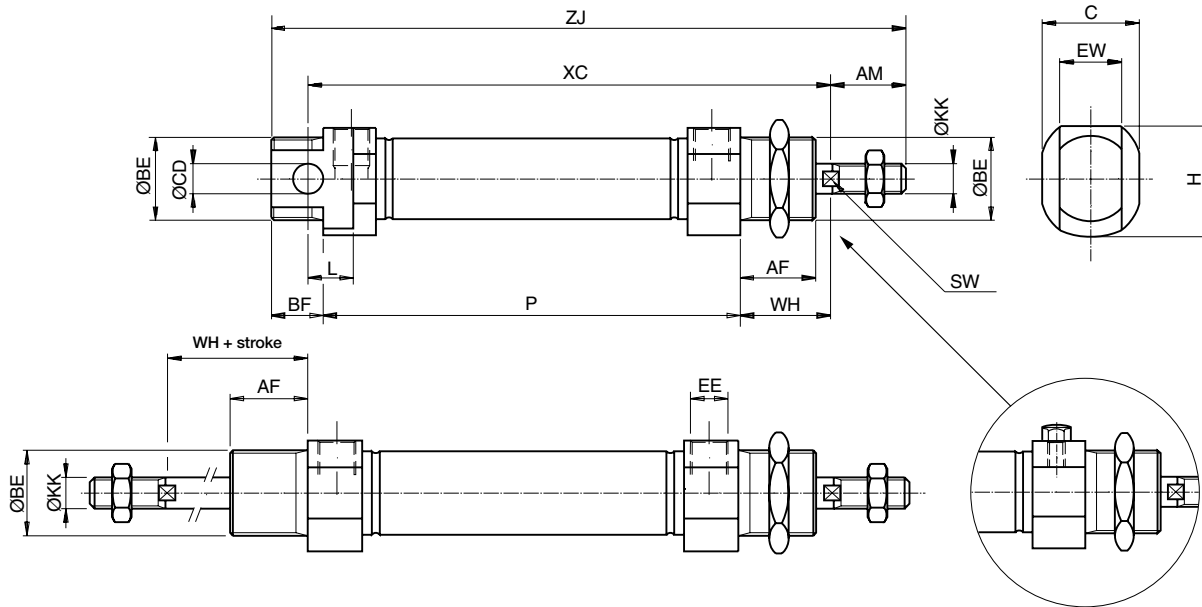

Dimensions

Cyl. bore mm	AM 0/-2 mm	BE	AF mm	BF mm	C mm	CDH9 mm	EE	EW mm	H mm	KK	L mm	SW mm	WH±1,2 mm
10	12	M12x1,25	12	10	14	4	M5	8	19	M4	6	-	16
12	16	M16x1,5	18	13	18	6	M5	12	19	M6	9	5	22
16	16	M16x1,5	18	13	18	6	M5	12	19	M6	9	5	22
20	20	M22x1,5	20	14	24	8	G1/8	16	29	M8	12	7	24
25	22	M22x1,5	22	14	28	8	G1/8	16	32	M10x1,25	12	9	28

Double acting cylinders

Cyl. bore mm	XC mm	ZJ mm	P mm
10	64 + stroke	84 + stroke	46 + stroke
12	75 + stroke	99 + stroke	48 + stroke
16	82 + stroke	104 + stroke	53 + stroke
20	95 + stroke	125 + stroke	67 + stroke
25	104 + stroke	132 + stroke	68 + stroke

Single acting with spring return, type SS

Stroke/ Cyl. bore mm	10 XC mm	15 XC mm	25 XC mm	40 XC mm	50 XC mm	80 XC mm	10 ZJ mm	15 ZJ mm	25 ZJ mm	40 ZJ mm	50 ZJ mm	80 ZJ mm	10 P mm	15 P mm	25 P mm	40 P mm	50 P mm	80 P mm
10	74	79	89	126	136	174	94	99	109	146	156	194	56	61	71	108	118	156
12	85	90	100	132	142	185	109	114	124	156	166	209	58	63	73	105	115	158
16	92	97	107	122	132	184	114	119	129	144	154	206	63	68	78	93	103	155
20	105	110	120	135	145	191	135	140	150	165	175	221	77	82	92	107	117	163
25	114	119	129	144	154	201	142	147	157	172	182	229	78	83	93	108	118	165

Length tolerances ±1 mm
 Stroke length tolerances +1,5/0 mm

Cylinders are supplied complete with mounting and adjusting nuts.
 Cylinders with through piston rod are supplied complete with two adjusting nuts and one mounting nut.

Refer to order code when ordering cylinders

See Order key on page 9

Cylinder mountings

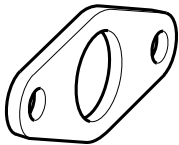
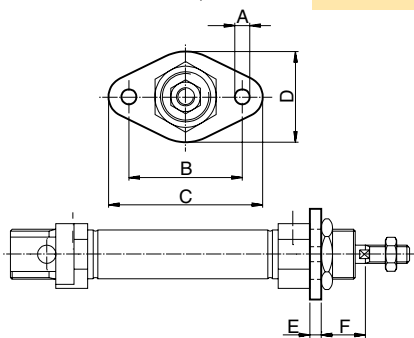
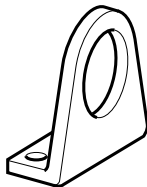
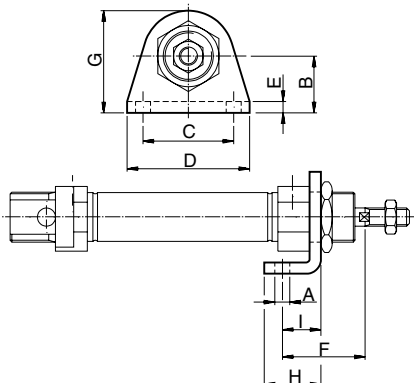
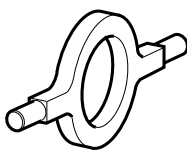
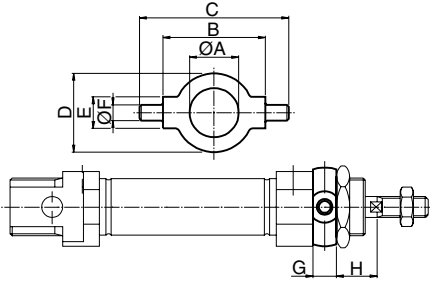
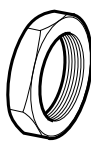
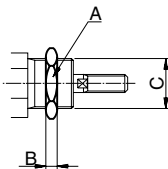
Type	Description	Cyl. bore Ø mm	Weight kg	Order code																																															
Flange-MF8 	Intended for fixed attachment of the cylinder. The flange is designed for mounting on the front or rear end-covers. Material: Stainless steel, DIN X 10 CrNiS 18 9	10	0,012	P1S-4CMB P1S-4DMB P1S-4HMB																																															
		12-16	0,025																																																
20-25	0,045																																																		
<table border="1"> <thead> <tr> <th>Cylinder Ø mm</th> <th>A mm</th> <th>B mm</th> <th>C mm</th> <th>D mm</th> <th>E mm</th> <th>F mm</th> </tr> </thead> <tbody> <tr> <td>10</td> <td>4,5</td> <td>30</td> <td>40</td> <td>22</td> <td>3</td> <td>13</td> </tr> <tr> <td>12-16</td> <td>5,5</td> <td>40</td> <td>52</td> <td>30</td> <td>4</td> <td>18</td> </tr> <tr> <td>20</td> <td>6,6</td> <td>50</td> <td>66</td> <td>40</td> <td>5</td> <td>19</td> </tr> <tr> <td>25</td> <td>6,6</td> <td>50</td> <td>66</td> <td>40</td> <td>5</td> <td>23</td> </tr> </tbody> </table>	Cylinder Ø mm	A mm	B mm	C mm	D mm	E mm	F mm	10	4,5	30	40	22	3	13	12-16	5,5	40	52	30	4	18	20	6,6	50	66	40	5	19	25	6,6	50	66	40	5	23																
Cylinder Ø mm	A mm	B mm	C mm	D mm	E mm	F mm																																													
10	4,5	30	40	22	3	13																																													
12-16	5,5	40	52	30	4	18																																													
20	6,6	50	66	40	5	19																																													
25	6,6	50	66	40	5	23																																													
Foot-MS3 	Intended for fixed attachment of the cylinder. The bracket is designed for mounting on the front or rear end-covers. Material: Stainless steel, DIN X 10 CrNiS 18 9	10	0,020	P1S-4CMF P1S-4DMF P1S-4HMF																																															
		12-16	0,040																																																
20-25	0,080																																																		
<table border="1"> <thead> <tr> <th>Cylinder Ø mm</th> <th>A mm</th> <th>B mm</th> <th>C mm</th> <th>D mm</th> <th>E mm</th> <th>F mm</th> <th>G mm</th> <th>H mm</th> <th>I mm</th> </tr> </thead> <tbody> <tr> <td>10</td> <td>4,5</td> <td>16</td> <td>25</td> <td>35</td> <td>3</td> <td>24</td> <td>26</td> <td>16</td> <td>11</td> </tr> <tr> <td>12-16</td> <td>5,5</td> <td>20</td> <td>32</td> <td>42</td> <td>4</td> <td>32</td> <td>32,5</td> <td>20</td> <td>14</td> </tr> <tr> <td>20</td> <td>6,5</td> <td>25</td> <td>40</td> <td>54</td> <td>5</td> <td>36</td> <td>45</td> <td>25</td> <td>17</td> </tr> <tr> <td>25</td> <td>6,5</td> <td>25</td> <td>40</td> <td>54</td> <td>5</td> <td>40</td> <td>45</td> <td>25</td> <td>17</td> </tr> </tbody> </table>	Cylinder Ø mm	A mm	B mm	C mm	D mm	E mm	F mm	G mm	H mm	I mm	10	4,5	16	25	35	3	24	26	16	11	12-16	5,5	20	32	42	4	32	32,5	20	14	20	6,5	25	40	54	5	36	45	25	17	25	6,5	25	40	54	5	40	45	25	17	
Cylinder Ø mm	A mm	B mm	C mm	D mm	E mm	F mm	G mm	H mm	I mm																																										
10	4,5	16	25	35	3	24	26	16	11																																										
12-16	5,5	20	32	42	4	32	32,5	20	14																																										
20	6,5	25	40	54	5	36	45	25	17																																										
25	6,5	25	40	54	5	40	45	25	17																																										
Cover trunnion 	Intended for articulated mounting of the cylinder. The flange is designed for mounting on the front or rear end-covers. Material: Stainless steel, DIN X 10 CrNiS 18 9	10	0,014	P1A-4CMJ P1A-4DMJ P1A-4HMJ																																															
		12-16	0,033																																																
20-25	0,037																																																		
<table border="1"> <thead> <tr> <th>Cylinder Ø mm</th> <th>A mm</th> <th>B h14 mm</th> <th>C mm</th> <th>D mm</th> <th>E e9 mm</th> <th>F mm</th> <th>G mm</th> <th>H mm</th> </tr> </thead> <tbody> <tr> <td>10</td> <td>12,5</td> <td>26</td> <td>38</td> <td>20</td> <td>8</td> <td>4</td> <td>6</td> <td>10</td> </tr> <tr> <td>12-16</td> <td>16,5</td> <td>38</td> <td>58</td> <td>25</td> <td>10</td> <td>6</td> <td>8</td> <td>14</td> </tr> <tr> <td>20</td> <td>22,5</td> <td>46</td> <td>66</td> <td>30</td> <td>10</td> <td>6</td> <td>8</td> <td>16</td> </tr> <tr> <td>25</td> <td>22,5</td> <td>46</td> <td>66</td> <td>30</td> <td>10</td> <td>6</td> <td>8</td> <td>20</td> </tr> </tbody> </table>	Cylinder Ø mm	A mm	B h14 mm	C mm	D mm	E e9 mm	F mm	G mm	H mm	10	12,5	26	38	20	8	4	6	10	12-16	16,5	38	58	25	10	6	8	14	20	22,5	46	66	30	10	6	8	16	25	22,5	46	66	30	10	6	8	20						
Cylinder Ø mm	A mm	B h14 mm	C mm	D mm	E e9 mm	F mm	G mm	H mm																																											
10	12,5	26	38	20	8	4	6	10																																											
12-16	16,5	38	58	25	10	6	8	14																																											
20	22,5	46	66	30	10	6	8	16																																											
25	22,5	46	66	30	10	6	8	20																																											
Mounting nut 	Intended for fixed mounting of the cylinder. Cylinders are supplied complete with one mounting nut. Material: Stainless steel, DIN X 5 CrNi 18 10	10	0,009	9127385111 9127385112 9127385113																																															
		12-16	0,018																																																
20-25	0,042																																																		
<table border="1"> <thead> <tr> <th>Cylinder Ø mm</th> <th>A mm</th> <th>B mm</th> <th>C</th> </tr> </thead> <tbody> <tr> <td>10</td> <td>16</td> <td>3</td> <td>M12x1,25</td> </tr> <tr> <td>12-16</td> <td>20</td> <td>4</td> <td>M16x1,50</td> </tr> <tr> <td>20-25</td> <td>27</td> <td>5</td> <td>M22x1,50</td> </tr> </tbody> </table>	Cylinder Ø mm	A mm	B mm	C	10	16	3	M12x1,25	12-16	20	4	M16x1,50	20-25	27	5	M22x1,50																																			
Cylinder Ø mm	A mm	B mm	C																																																
10	16	3	M12x1,25																																																
12-16	20	4	M16x1,50																																																
20-25	27	5	M22x1,50																																																

Cylinder mountings

Type	Description	Cyl. bore Ø mm	Weight kg	Order code
Clevis bracket	Intended for articulated mounting of the cylinder. Supplied with shaft for mounting on the rear end cover. Material: Bracket: stainless steel, DIN X 5 CrNi 18 10 Pin: tempered stainless steel, DIN X 20 Cr 13 Locking rings: stainless steel, DIN X 5 CrNi 18 10	10	0,020	P1S-4CMT P1S-4DMT P1S-4HMT
		12-16	0,040	
		20-25	0,080	

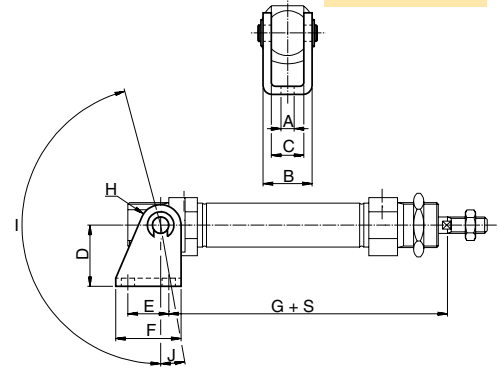

Cylinder Ø mm	A mm	B mm	C mm	D mm	E mm	F mm	G mm	H mm	I °	J °
10	4,5	13	8	24	12,5	20	65,3	5	160	17
12	5,5	18	12	27	15	25	73	7	170	15
16	5,5	18	12	27	15	25	80	7	170	15
20	6,5	24	16	30	20	32	91	10	165	10
25	6,5	24	16	30	20	32	100	10	165	10

S=stroke

Clevis	According to ISO 8140 Intended for articulated mounting of the cylinder. This mounting is adjustable in the axial direction. Supplied complete with pin. Material: Stainless steel, DIN X 5 CrNi 18 10	10	0,007	P1S-4CRD P1S-4DRD P1S-4HRD P1S-4JRD
		12-16	0,022	
		20	0,045	
		25	0,095	

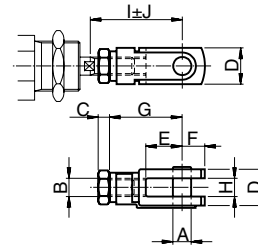
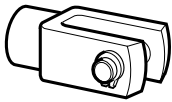

Cylinder Ø mm	A mm	B	C mm	D mm	E mm	F mm	G mm	H mm	I mm	J mm
10	4	M4	2,2	8	8	5	16	4	22	2
12-16	6	M6	3,2	12	12	7	24	6	31	3
20	8	M8	4	16	16	10	32	8	40,5	3,5
25	10	M10x1,25	5	20	20	12	40	10	49	3

Swivel rod eye	According to ISO 8139 Intended for articulated mounting of the cylinder. This mounting is adjustable in the axial direction. Material: Swivel rod eye: stainless steel, DIN X 5 CrNi 18 10 Ball: hardened stainless steel, DIN X 5 CrNi 18 10	10	0,017	P1S-4CRT P1S-4DRT P1S-4HRT P1S-4JRT
		12-16	0,025	
		20	0,045	
		25	0,085	

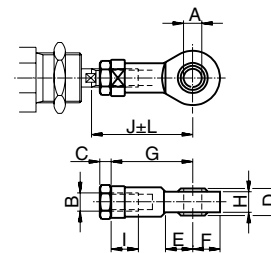
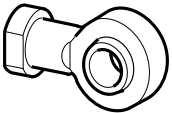

Cylinder Ø mm	A mm	B	C mm	D mm	E mm	F mm	G mm	H mm	I mm	J mm	K mm	L mm
10	5	M4	2,2	8	10	9	27	6	8	33	9	2
12-16	6	M6	3,2	9	10	10	30	6,8	9	38,5	11	1,5
20	8	M8	4	12	12	12	36	9	12	46	14	2
25	10	M10x1,25	5	14	14	14	43	10,5	15	52,5	17	2,5

Rod nut	Intended for fixed mounting on the piston rod. Cylinders are supplied complete with one rod nut. (cylinders with through piston rod are supplied with two rod nuts.) Material: Stainless steel, DIN X 5 CrNi 18 10	10	0,001	9127385121 9127385122 9127385123 9126725404
		12-16	0,002	
		20	0,005	
		25	0,007	

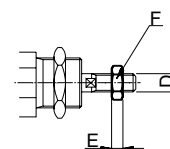

Cylinder Ø mm	D	F mm	E mm
10	M4	7	2,2
12-16	M6	10	3,2
20	M8	13	4
25	M10x1,25	17	5

Main data: ISO 6431

Cylinder designation	Cylinder bore area		Piston rod diam. area thread			Cushioning distance mm	Total mass at addition		Moving mass at addition		Air consumption litres	Port thread
	mm	cm ²	mm	cm ²	mm		0 mm stroke kg	per 10 mm stroke kg	0 mm stroke kg	per 10 mm stroke kg		
P1S-•Ø32M	32	8,0	12	1,1	M10x1,25	15	0,59	0,026	0,10	0,009	0,105 ¹⁾	G1/8
P1S-•Ø40M	40	12,6	16	2,0	M12x1,25	18	0,99	0,036	0,19	0,016	0,162 ¹⁾	G1/4
P1S-•Ø50M	50	19,6	20	3,1	M16x1,5	19	1,63	0,057	0,32	0,024	0,253 ¹⁾	G1/4
P1S-•Ø63M	63	31,2	20	3,1	M16x1,5	22	2,75	0,065	0,36	0,024	0,414 ¹⁾	G3/8
P1S-•Ø80M	80	50,3	25	4,9	M20x1,5	24	5,09	0,099	1,11	0,039	0,669 ¹⁾	G3/8
P1S-•100M	100	78,5	25	4,9	M20x1,5	29	8,68	0,115	1,41	0,039	1,043 ¹⁾	G1/2
P1S-•125M	125	122,7	32	8,0	M27x2	32	15,31	0,174	2,90	0,063	1,662 ¹⁾	G1/2

1)Free air consumption per 10 mm stroke length for a double stroke at 600 kPa (6 bar)

Cylinder forces

Indicated cylinder forces are theoretical and should be reduced in relation to working conditions.

Cylinder designation	Theoretical cylinder force at 600 kPa (6 bar)	
	exp. stroke N	return stroke N
P1S-•Ø32M	480	415
P1S-•Ø40M	754	633
P1S-•Ø50M	1180	990
P1S-•Ø63M	1870	1680
P1S-•Ø80M	3016	2721
P1S-•100M	4712	4417
P1S-•125M	7363	6880

Working medium, air quality

Working medium Dry, filtered compressed air to ISO 8573-1 class 3.4.3.

Recommended air quality for cylinders

For best possible service life and trouble-free operation, ISO 8573-1 quality class 3.4.3 should be used. This means 5 µm filter (standard filter) dew point +3 °C for indoor operation (a lower dew point should be selected for outdoor operation) and oil concentration 1.0 mg oil/m³, which is what a standard compressor with a standard filter gives.

ISO 8573-1 quality classes

Quality class	Pollution particle size (µm)	max concentration (mg/m ³)	Water max. press. dew point (°C)	Oil max concentration (mg/m ³)
1	0,1	0,1	-70	0,01
2	1	1	-40	0,1
3	5	5	-20	1,0
4	15	8	+3	5,0
5	40	10	+7	25
6	-	-	+10	-

Additional data

Working pressure max 10 bar
 Working temperature max +80 °C
 min -20 °C

High-temperature version max +150 °C
 min -10 °C

Low-temperature version max +40 °C
 min -40 °C
 Ø80 - Ø125

Prelubricated, further lubrication is not normally necessary. If additional lubrication is introduced it must be continued.

Cushioning diagram

Use the diagram below to determine the necessary size of cylinder to provide the requisite cushioning performance. The maximum cushioning performance, as indicated in the diagram, is based on the following assumptions:

- Low load, i.e. low pressure drop across the piston
- Steady-state piston speed
- Correctly adjusted cushioning screw

The load is the sum of the internal and external friction, together with any gravity forces. At high relative loading it is recommended that, for a given speed, the load should be reduced by a factor of 2.5, or that, for a given mass, the speed should be reduced by a factor of 1.5. These factors apply in relation to the maximum performance as shown in the diagram.

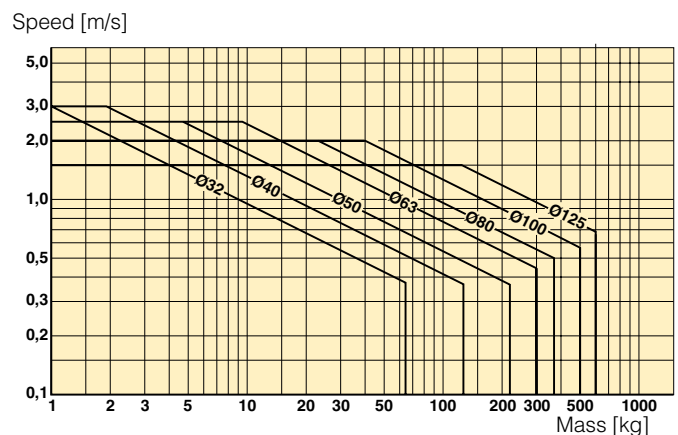

Introduction to the ATEX directive

Explosive atmospheres

Directive 94/9/EC defines an explosive atmosphere as a mixture of:

- a) **flammable substances** – gases, vapours, mists or dusts
 - b) with **air**
 - c) under specific **atmospheric conditions**
 - d) in which, after ignition has occurred, combustion spreads to the entire flammable mixture
- (NB: with regard to dust, it may be that not all dust is combusted after ignition has occurred)

An atmosphere with the potential to become an explosive atmosphere during operating conditions and/or under the influence of the surroundings is defined as a **potentially explosive atmosphere**. Products covered by directive 94/9/EC are defined as intended for use in potentially explosive atmospheres.

Harmonised European ATEX standard

The European Union has adopted two harmonised directives in the field of health and safety. The directives are known as ATEX 100a and ATEX 137.

Directive ATEX 100a (94/9/EC) lays down minimum safety requirements for products intended for use in potentially explosive atmospheres in European Union member states. Directive ATEX 137 (99/92/EC) defines minimum requirements for health and safety at the workplace, for working conditions and for the handling of products and materials in potentially explosive atmospheres. This directive also divides the workplace into **zones** and defines criteria by which products are **categorised** within these zones.

The table below describes the **zones** in an installation where there is a potential for explosive atmospheres. The **owner** of the installation must analyse and assess the area in which the explosive gas/dust mixture may occur, and if necessary must divide it into **zones**. This process of zoning then allows the correct plant and equipment to be selected for use in the area.

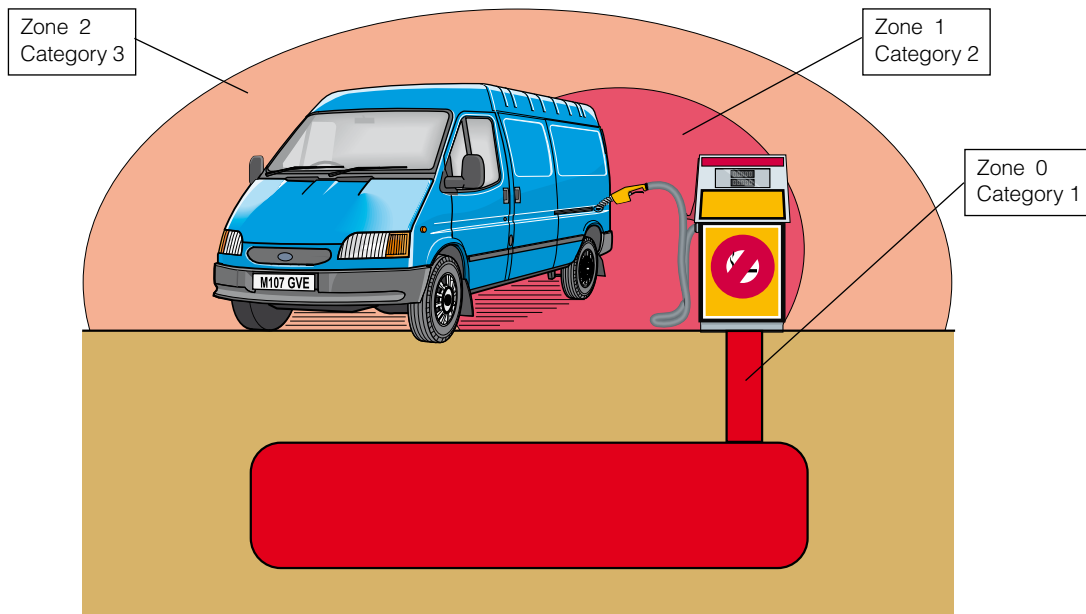

Zones		Presence of potentially explosive atmosphere	Type of risk
Gas G	Dust D		
0	20	Present continuously or for long periods	Permanent
1	21	Likely to occur in normal operation occasionally	Potential
2	22	Not likely to occur in normal operation but, if it does occur, will persist for a short period only	Minimal

The ATEX directive has been in force throughout the European Union since 1 July 2003, replacing the existing divergent national and European legislation relating to explosive atmospheres. Please note that for the first time, the directive covers mechanical, hydraulic and pneumatic equipment and not just electrical equipment as before.

With regard to the **Machinery directive 98/37/EC**, note that a number of external requirements in 94/9/EC refer to hazards arising from potentially explosive atmospheres, where the Machinery directive only contains general requirements relating to explosion safety (Annex I 1.5.7).

As a result, directive 94/9/EC (ATEX 100a) takes precedence over the Machinery directive with regard to explosion protection in potentially explosive atmospheres. The requirements in the Machinery directive are applicable to all other risks relating to machinery.

Levels of protection for the various equipment categories

The various equipment categories must be capable of operating in accordance with the manufacturer’s operating specifications at defined levels of protection.

Level of protection	Category		Type of protection	Operating specifications
	Group I	Group II		
Very high	M1		Two independent means of protection or safety, ensuring that the equipment remains functional even in the event of two faults occurring independently of each other	The equipment remains energised and functional even with an explosive atmosphere present
Very high		1	Two independent means of protection or safety, ensuring that the equipment remains functional even in the event of two faults occurring independently of each other	The equipment remains energised and functional in zones 0, 1, 2 (G) and/or zones 20, 21, 22 (D)
High	M2		Protection suitable for normal operation and severe operating conditions	The equipment is de-energised in the event of an explosive atmosphere
High		2	Protection suitable for normal operation and frequent faults, or equipment in which faults normally have to be taken into account	The equipment remains energised and functional in zones 1, 2 (G) and/or zones 21, 22 (D)
Normal		3	Protection suitable for normal operation	The equipment remains energised and functional in zones 2 (G) and/or zones 22 (D)

Definition of groups (EN 1127-1)

Group I Equipment intended for use in underground parts of mines as well as those parts of surface installations of such mines likely to be endangered by flammable vapours and/or flammable dusts.

Group II Equipment intended for use in other places exposed to explosive atmospheres.

Group	I mines, combustible vapours		II other potentially explosive atmospheres (gases, dust)					
	M1	M2	1		2		3	
Category								
Atmosphere*			G	D	G	D	G	D
Zone			0	20	1	21	2	22

G = gas and D = dust

Temperature classes

Classification of flammable gases and vapours on the basis of ignition temperature

Temperature class	Ignition temperature °C
T1	Over 450
T2	(300) – 450
T3	(200) – 300
T4	(135) – 200
T5	(100) – 135
T6	(85) - 100

Declaration of conformity

The product catalogues contain copies of the declaration of conformity demonstrating that the product meets the requirements of directive 94/9/EC.

The declaration is only valid in conjunction with the instructions contained in the installation manual relating to the safe use of the product throughout its service life.

The instructions relating to the conditions in the surrounding area are particularly important, as the certificate is invalidated if the instructions are found not to have been adhered to during operation of the product. If there is any doubt as to the validity of the certificate of conformity, contact Parker Hannifin customer service.

Operation, installation and maintenance

The installation manual of the product contains instructions relating to the safe storage, handling, operation and servicing of the product.

The manual is available in different languages, and can be downloaded from www.parker.com/euro_pneumatic.

This document must be made accessible in a suitable place near where the product is installed. It is used as a reference for all personnel authorised to work with the product throughout its service life. We, the manufacturer, reserve the right to modify, extend or improve the installation manual in the interests of the users.

For more information about ATEX see EUs homepage: <http://europa.eu.int/comm/enterprise/atex/>



Safety instructions for the P1S cylinder with accessories

Supplementary safety instructions for installation of ATEX certified P1S cylinders.

The safety instructions in this document are valid for the ATEX certified P1S cylinders, bore 32 - 125mm, as per below with reference to the order code key in the product catalogue.

P1S-C***MS-****-EX
 P1S-D***MS-****-EX
 P1S-E***MS-****-EX
 P1S-F***MS-****-EX
 P1S-L***MS-****-EX

All strokes in the range 25 - 1000mm

Serious, even fatal, damage or injury may be caused by the hot moving parts of the P1S cylinders in the presence of explosive gas mixtures and concentrations of dust.

All installation, connection, commissioning, servicing and repair work on P1S cylinders must be carried out by qualified personnel taking account of the following

- These instructions
- Markings on the cylinder
- All other planning documents, commissioning instructions and connection diagrams associated with the application.
- Provisions and requirements specific to the application
- National/international regulations (explosion protection, safety and accident prevention)

Real life applications

P1S cylinders are designed to provide linear movement in industrial applications, and should only be used in accordance with the instructions in the technical specifications in the catalogue, and within the operating range indicated on the rating plate. The cylinders meet the applicable standards and requirements of directive 94/9/EC (ATEX)

The cylinders must not be used underground in mines susceptible to firedamp and/or flammable dusts. The cylinders are intended for use in areas in which explosive atmospheres caused by gases, vapours or mists of flammable liquids, or air/dust mixtures may be expected to occur during normal use (infrequently)

Checklist

Before using the cylinders in an Ex-area, you should check the following:

Do the specifications of the P1S cylinder match the Ex-classification of the area of use in accordance with directive 94/9/EC (previously ATEX 100a)

- Equipment group
- Ex-equipment category
- Ex-zone
- Temperature class
- Max. surface temperature

1. When installing the P1S cylinder, is it certain that there is no potentially explosive atmosphere, oil, acids, gases, vapours or radiation?
2. Is the ambient temperature as specified in the technical data in the catalogue at all times?
3. Is it certain that the P1S cylinder is adequately ventilated and that no forbidden additional heat is added?
4. Are all the driven mechanical components ATEX certified?
5. Check that the P1S cylinder is safely earthed.
6. Check that the P1S cylinder is supplied with compressed air. Explosive gas mixtures must not be used for driving the cylinder.
7. Check that the P1S cylinder is not equipped with a metal scraper ring (special version).

Installation requirements in Ex-areas

- The temperature of the supply air must not exceed the ambient temperature.
- The P1S cylinder may be installed in any position.
- The P1S cylinder must not be installed where there is a risk of mechanical contact with any surrounding part or component.
- An air treatment unit must be attached to the inlet of the P1S cylinder.
- The P1S cylinder must be connected to earth at all times, through its support, a metallic tube or separate conductor.
- The outlet of the P1S cylinder must not be open within an Ex-area, but must be connected to the silencer or, preferably, piped and released outside the Ex-area.
- The P1S cylinder may only drive units that are ATEX certified.
- Ensure that the P1S cylinder is not exposed to forces greater than those permitted in accordance with the catalogue
- The P1S cylinder must be supplied with compressed air. Explosive gas mixtures must not be used
- P1S cylinders with metal scraper rings must not be used in Ex-areas

Inspecting cylinders during operation

The P1S cylinder must be kept clean on the outside, and a layer of dust/dirt thicker than 1 mm must never be allowed to form. Inspect and verify that the cylinder, with attachments, compressed air fittings, hoses, tubes, etc. meet the standards of "safe" installation.

Spare parts

Only spare parts, kits etc. supplied by Parker Hannifin may be used for repair and maintenance of the P1S cylinders.

Marking of ATEX certified P1S cylinders

The ATEX certified P1S cylinders, bore 32 - 125mm, as per below with reference to the order code key in the product catalogue have an ATEX certification marking as shown further below.

P1S-C***MS-****-EX
 P1S-D***MS-****-EX
 P1S-E***MS-****-EX
 P1S-F***MS-****-EX
 P1S-L***MS-****-EX

All strokes in the range 25 - 1000mm



Communauté Européenne = EU

CE on the product shows that Parker Hannifin products meet one or more EU directives



Ex means that this product is intended for use in potentially explosive atmospheres

II

Stands for the equipment group (I = mines and II = other hazardous areas)

2GD

Stands for equipment category 2G means the equipment can be used in zones 1 and 2 where there is a risk involving gases, vapours or mists of combustible liquids and 2D in zones 21 and 22 where there is a risk involving dusts. 2GD Means the equipment can be used in zones 1, 2, 21 and 22.

c

Safe design (prEN 13463-5)

T4

If equipment is in temperature class T4, the maximum surface temperature must not exceed 135 °C. (To guarantee this, the product has been tested to ensure that the maximum is 130 °C. This provides a safety margin of 5 °K.)

120 °C

Maximum permitted surface temperature on P1D-S cylinder in atmospheres containing potentially explosive dusts.

Supplementary safety instructions for P8S-GPFLX/ EX sensors installed in Ex-areas

Serious, even fatal, damage or injury may be caused by the hot moving parts of the P1S cylinders in the presence of explosive gas mixtures and concentrations of dust.

Instructions for use

Safety instructions

- Cylinder sensor ATEX classed for category II3G and II3D
- Ambient temperature $T_a = -20\text{ °C}$ to $+45\text{ °C}$
- Temperature class T4, or max. surface temperature of $T = 135\text{ °C}$
- Protection class IP67
- Read installation instructions before startup
- Installation, connection and commissioning must be carried out by trained personnel

Applications

- This sensor is designed for use in the T-groove of cylinders, and detects the magnetic field in potentially explosive areas. The sensor can only be installed in the T-groove of these cylinders.
- The sensor may also be installed on round cylinders by means of the following attachments:

P8S-TMC01 Suitable for P1S and P1A diameter 10 - 25 mm

P8S-TMC02 Suitable for P1S diameter 32 - 63 mm

P8S-TMC03 Suitable for P1S diameter 80 - 125 mm

The following data applies to these attachments:

- Ambient temperature $T_a = 0\text{ °C}$ to 45 °C
- Low energy absorption to EN 50 021
- The sensor may also be installed on tie-rod cylinders or profile cylinders by means of this attachment:
P8S-TMA0X Suitable for P1D-T diameter 32 - 125 mm, P1E-T diameter 160 - 200 mm and C41 diameter 160 - 200 mm

Installation

General: The sensor must be protected from UV radiation. The cable must be installed such that it is protected from external influences, for example it may be necessary to attach an external strain relief to the cable.

Technical data for sensor

Operating voltage $U_b = 18$ to 30 V DC

Max. load current $I_a \leq 70\text{ mA}$

Ambient temperature: -20 °C to 45 °C

Commissioning

When connecting the sensor to a power source, please pay attention to the following

- a) the load data (operating voltage, continuous load current)
- b) the wiring diagram for the sensor

Maintenance

Our P8S-GPFLX/EX cylinder sensor is maintenance free, but the cable connections should be checked at regular intervals.

The sensor must be protected from UV radiation. The sensor must be kept clean on the outside, and a layer of dirt thicker than 1 mm must never be allowed to form. Strong solvents should not be used for cleaning as they may damage the sensor.

P8S-GPFLX/EX cylinder sensor



Communauté Européenne = EU

CE on the product shows that Parker Hannifin products meet one or more EU directives



Ex means that this product is intended for use in potentially explosive atmospheres

II

Stands for the equipment group (I = mines and II = other hazardous areas)

3G

Stands for the equipment category 3G means the equipment can be used in zone 2 where there is a risk involving gases, vapours or mists of combustible liquids

EEx

EEx means that this is an electrical product intended for use in Ex-areas

nA II

n Not ignitable to EN50021, A Explosion group tested with acetone, ethanol, toluene and xylene; II Not for use in the mining industry

T4 X

If equipment is in temperature class T4, the maximum surface temperature must not exceed 135 °C . (To guarantee this, the product has been tested to ensure that the maximum is 130 °C . This provides a safety margin of 5 °C .) X Must be installed in accordance with the installation manual

3D

Stands for equipment category 3D in zone 22 where there is a risk involving dusts.

135 °C

Maximum permitted surface temperature on the motor in atmospheres containing potentially explosive dusts.

IP67

Satisfies protection class IP67

Components such as cylinder attachments, tube fittings, tubes, etc.

Components

Parker Hannifin guarantees that our cylinder mountings, tube fittings, tubes, etc. are not ignition sources and are therefore not subject to the provisions of the ATEX directive.

A component means any item essential to the safe functioning of equipment and protective systems but with no autonomous function.

Components intended for incorporation into equipment or protective systems which are accompanied by an attestation of conformity with the ATEX directive, including a statement of their characteristics and how they must be incorporated into products, are considered to conform to the applicable provisions of directive 94/9/EC.

Ex-components as defined in the European standard EN 50014 are components in the sense of the ATEX directive 94/9/EC as well. Components must not have the CE marking affixed unless otherwise required by other directives.

Examples of components:



- terminals
- push buttons assemblies
- relays
- empty flameproof enclosures
- ballasts for fluorescent lamps
- meters (e.g. moving coil)
- encapsulated relays and contactors, with terminals and/or flying leads

Order key

P1S-D **032** **M** **S** - **0025** - **EX**



Cylinder version	
C	Threaded front end
D	Threaded front end + 4 mounting holes in rear end cover
E	4 mounting holes in front end cover, only Ø80 - Ø125
F	4 mounting holes in rear end cover
L	4 mounting holes in front and rear end cover, only Ø80 - Ø125

Cylinder bore mm
032
040
050
063
080
100
125

Cylinder type/Function	
M	 Double acting, adjustable cushioning
F	 Double acting, adjustable cushioning, through piston rod, only Ø80 - Ø125

ATEX	
Add for ATEX certified product	

Stroke in mm	
E.g. 0025 = 25 mm	
For standard stroke length and max length, see table below	

Sealing material	
S	Standard, -20 °C to +80 °C Magnetic piston
F	 High temperature, -10 °C to +150 °C Non magnetic piston
L	 Low temperature, -40 °C to +60 °C Non magnetic piston only Ø80 - Ø125
Q	Stainless steel scraper for piston rod -20 °C to +80 °C Magnetic piston only Ø80 - Ø125

Stroke length

Cylinder designation	Cylinder bore	● Standard stroke length in mm according to ISO 4393											Non standard stroke length
		25	50	80	100	125	160	200	250	320	400	500	
P1S-•032M	32	●	●	●	●	●	●	●	●	●	●	●	●
P1S-•040M	40	●	●	●	●	●	●	●	●	●	●	●	●
P1S-•050M	50	●	●	●	●	●	●	●	●	●	●	●	●
P1S-•063M	63	●	●	●	●	●	●	●	●	●	●	●	●
P1S-•080M	80	●	●	●	●	●	●	●	●	●	●	●	●
P1S-•100M	100	●	●	●	●	●	●	●	●	●	●	●	●
P1S-•125M	125	●	●	●	●	●	●	●	●	●	●	●	●

CE  **II 2GD c T4 120 °C**

- P1S-C***MS-****-EX
- P1S-D***MS-****-EX
- P1S-E***MS-****-EX
- P1S-F***MS-****-EX
- P1S-L***MS-****-EX

All strokes in the range 25 - 1000mm
See ATEX information pages 14 to 17



CAD drawings on the Internet

Our home page www.parker.com/euro_pneumatic includes the Cad Drawing Library with 2D and 3D drawings for the main versions.

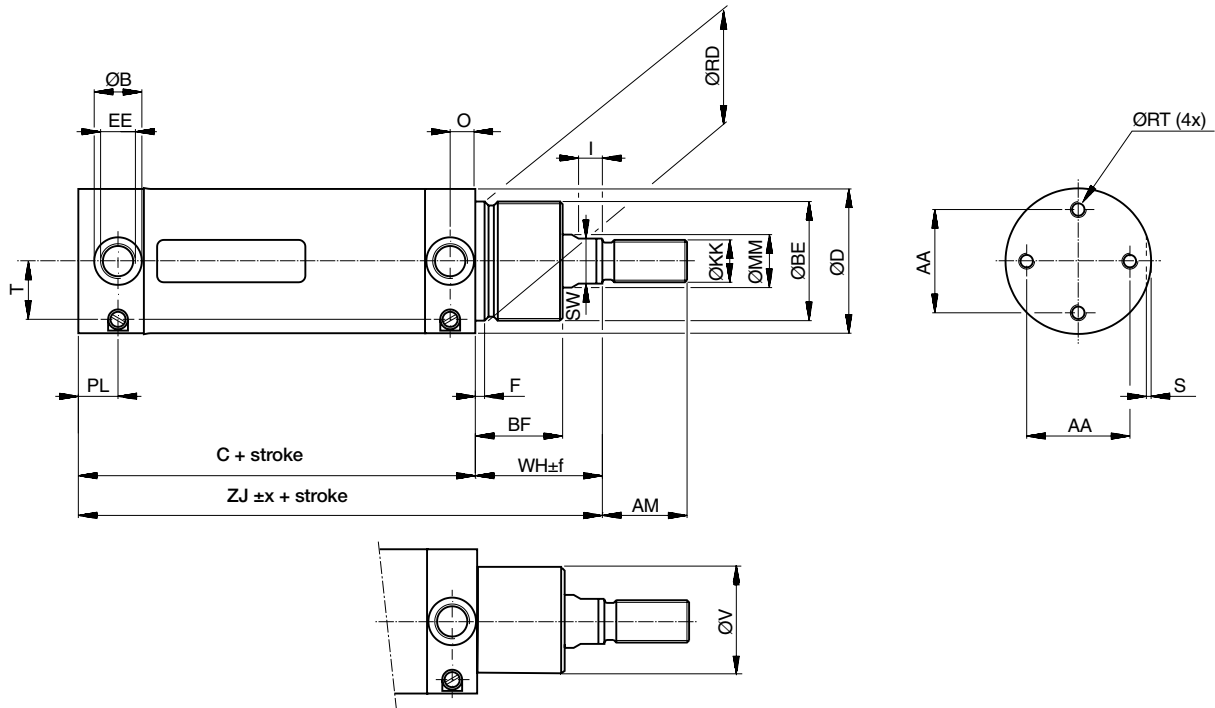

Not threaded front end

Dimensions Ø32-Ø63

Cylinder designation	AA	AM	B	BF	BE	C	D	EE	F	I	KK	MM	O	PL	RD	RT
	mm	mm	mm	mm	mm	mm	mm	mm	mm	mm	mm	mm	mm	mm	mm	mm
P1S-D032M	24,5	22	15	25	M30x1,5	88	36	G1/8	4,2	6	M10x1,25	12	8	13	30	M5
P1S-D040M	30	24	18	30	M38x1,5	97	44	G1/4	4,5	9	M12x1,25	16	9,5	15	38	M6
P1S-D050M	39	32	18	33	M45x1,5	101	55	G1/4	4,5	9	M16x1,5	20	9,5	15	45	M6
P1S-D063M	49	32	25	33	M45x1,5	117	68	G3/8	4,5	9	M16x1,5	20	13,3	20,5	45	M8

Cylinder designation	S	SW	T	V	WH	ZJ	Mounting tolerances		Stroke length
	mm	mm	mm	mm	mm	mm	x	f	0-500 mm
							mm	mm	mm
P1S-D032M	1,5	10	12,2	26	35,5	123,5	1,2	2,5	+2,0
P1S-D040M	1,5	14	16,5	35	44	141	1,0	2,2	+2,0
P1S-D050M	1,5	17	22	41	47	148	0,9	2,3	+2,0
P1S-D063M	1,5	17	26	41	47	164	1,4	2,3	+2,5

Material specification Ø32-Ø63

Piston rod	Stainless steel, DIN X 2 CrNiMo 17 13 2
Piston rod nut	Stainless steel, DIN X 5 CrNi 18 10
Piston rod seal	UHMWPE-plastic/NBR
Scraper ring	UHMWPE-plastic/fluorocarbon rubber, FPM
Piston rod bearing	HDPE-plastic
End covers	Stainless steel, DIN X 5 CrNi 18 10
Cushioning screw	Stainless steel, DIN X 10 CrNiS 18 9
Cushioning screw lockings	Stainless steel, DIN X 5 CrNi 18 10
Cushioning sealing	NBR
O-ring, cushioning screw	Fluorocarbon, FPM
O-ring, internal	NBR
Cylinder barrel	Stainless steel, DIN X 5 CrNi 18 10
Piston	POM plastic
Piston seal	NBR
Piston nut	Zinc plated steel
Magnet	Plastic-coated magnetic material

Variants Ø32-Ø63:

High-temperature version, type F:	
Sealings/scraper ring	Fluorocarbon rubber, FPM
Piston	Anodized aluminium

Refer to order code when ordering cylinders

See Order key on page 18

CAD drawings on the Internet

Our home page www.parker.com/euro_pneumatic includes the Cad Drawing Library with 2D and 3D drawings for the main versions.

Through piston rod

Basic cylinder

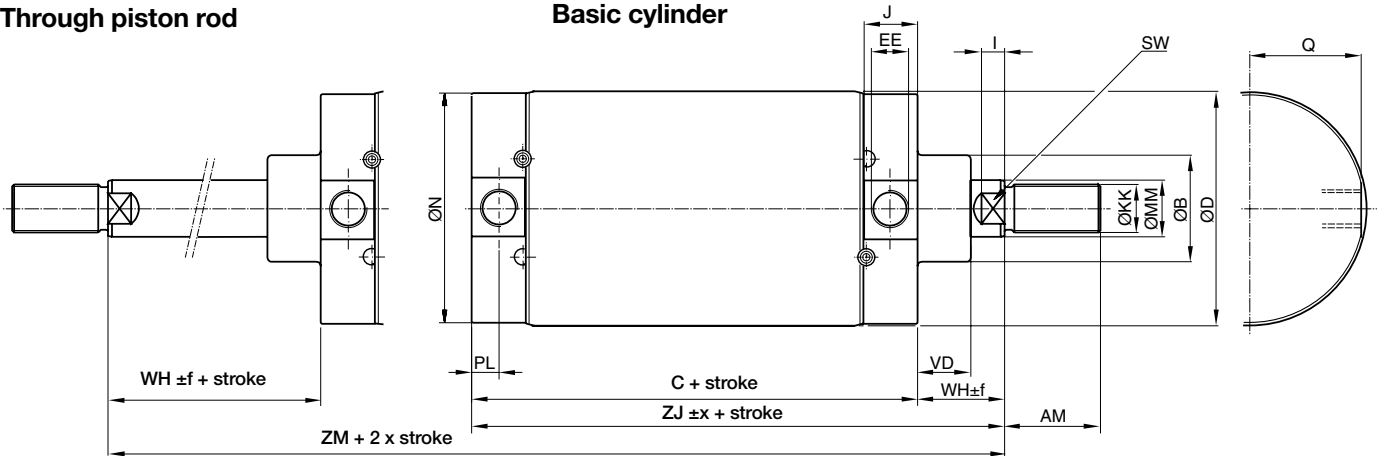

Threaded front end

Mounting holes in the end covers

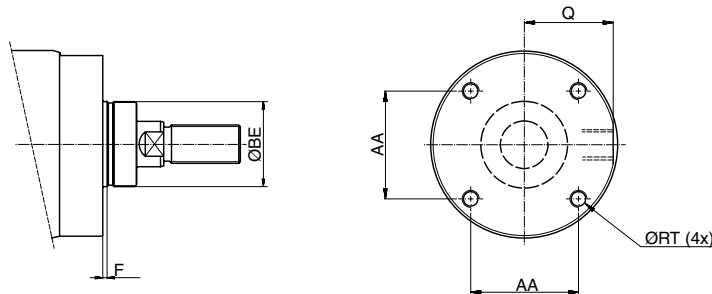

Dimensions Ø80-Ø125

Cylinder designation	AA	AM	B	BE	C	D	EE	F	KK	I	J	MM	N	PL	Q
	mm	mm	mm		mm	mm		mm		mm	mm	mm	mm	mm	mm
P1S-•080M	46	40	50	M50x1,5	141	86	G3/8	4	M20x1,5	10	24,5	25	84	12,5	40
P1S-•100M	60	40	50	M50x1,5	158	106	G1/2	4	M20x1,5	8	30	25	104	15,5	49,5
P1S-•125M	76	54	60	M60x2	183	133	G1/2	4	M27x2	13	30	32	129	15,5	62,5

Cylinder designation	RT	SW	VD	WH	ZJ	ZM	Mounting tol.	Stroke length
	mm	mm	mm	mm	mm	mm	x f	0-500 mm
							mm mm	
P1S-•080M	M8	21	19	37	178	215	1,5 2,5	+2,5
P1S-•100M	M10	21	19	35	193	228	1,5 2,5	+2,5
P1S-•125M	M12	27	24	47	230	277	2,0 2,5	+4,0

Material specification Ø80-Ø125

Piston rod	Stainless steel, DIN X 2 CrNiMo 17 13 2
Piston rod nut	Acid-proof steel, A4
Piston rod seal	FPM
Scraper ring	PTFE
Piston rod bearing	Multilayer PTFE and steel
End covers	Stainless steel, DIN X 5 CrNi 18 10
Cushioning screw	Stainless steel, DIN X 10 CrNiS 18 9
Cushioning sealing	NBR
O-ring, cushioning screw	Fluorocarbon, FPM
O-ring, internal	NBR
Cylinder barrel	Stainless steel, DIN X 5 CrNi 18 10
Piston	Anodized aluminium
Piston seal	NBR
Piston bearing	UHMWPE-plastic
Magnetic band	Rubber-coated magnetic material

Variants Ø80-Ø125:

Low-temperature version, type L:

Sealings/scraper ring NBR/PTFE

High-temperature version, type F:

Sealings/scraper ring Fluorocarbon rubber, FPM/PTFE

Cylinders with steel scraper ring, type Q:

Sealings/scraper ring NBR/Stainless steel

Refer to order code when ordering cylinders

See Order key on page 18

Cylinder mountings Ø32 - Ø63

Type	Description	Cyl. bore Ø mm	Weight kg	Order code
Clevis bracket MP4	Intended for articulated mounting of the cylinder versions D or F. The bracket is mounted at the rear end cover and is supplied complete with shaft, mounting screw and O-ring for a clean joint between end cover and bracket.	32	0,09	P1S-4KME P1S-4LME P1S-4MME P1S-4NME
		40	0,12	
		50	0,19	
		63	0,34	

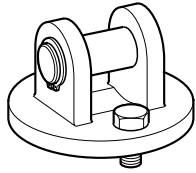

Material:
Stainless steel, DIN X 5 CrNi 18 10

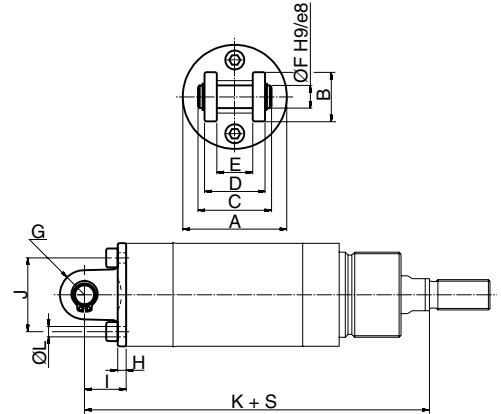

Cylinder Ø mm	A mm	B mm	C mm	D mm	E mm	F mm	G mm	H mm	I mm	J mm	K mm	L mm
32	35,5	20	33	26	15	10	10	4,5	18,5	25	142	5,5
40	43,5	24	35	28	17	12	12	4	19	30	160	6,5
50	54,5	26	39	32	17	12	13	4,5	22	39	170	6,5
63	67,5	34	47	40	22	16	17	6	26	49	190	8,6

S = Stroke

Mounting nut

Intended for fixed mounting of the cylinder via the neck.

32	0,03	9127294401 9127294402 9127294403
40	0,06	
50-63	0,08	

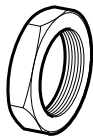

Material: stainless steel, DIN X 5 CrNi 18 10

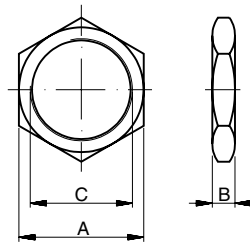

Cylinder Ø mm	A mm	B mm	C
32	36	8	M30x1,5
40	46	10	M38x1,5
50	55	10	M45x1,5
63	55	10	M45x1,5

Cylinder mountings Ø32-Ø125

Type	Description	Cyl. bore Ø mm	Weight kg	Order code
Acid-proof rod nut	Intended for fixed mounting on the piston rod. Cylinders are supplied complete with one rod nut. (cylinders with through piston rods are supplied with two rod nuts.)	32	0,007	0261109919 0261109920 0261109917 0261109917 0261109916 0261109916 0261109918
		40	0,010	
		50	0,021	
		63	0,021	
		80	0,040	
		100	0,040	
		125	0,100	
Stainless steel rod nut	Intended for fixed mounting of accessories to the piston rod.	32	0,007	9126725404 9126725405 9126725406 9126725406 0261109921 0261109921 0261109922
		40	0,010	
		50	0,021	
		63	0,021	
		80	0,040	
		100	0,040	
		125	0,100	

Cylinder Ø mm	A mm	B mm	C
32	17	5	M10x1,25
40	19	6	M12x1,25
50	24	8	M16x1,5
63	24	8	M16x1,5
80	30	10	M20x1,5
100	30	10	M20x1,5
125	41	13,5	M27x2

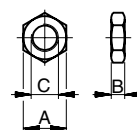

Cylinder mountings Ø32 - Ø125

Type	Description	Cyl. bore Ø mm	Weight kg	Order code
------	-------------	-------------------	--------------	------------

Swivel rod eye

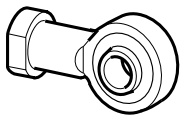

According to ISO 8139
Intended for articulated mounting of the cylinder. This mounting is adjustable in the axial direction.

Material:
Swivel rod eye: stainless steel, DIN X 5 CrNi 18 10
Ball: hardened stainless steel, DIN X 5 CrNi 18 10

32	0,08	P1S-4JRT P1S-4LRT P1S-4MRT P1S-4PRT P1S-4RRT
40	0,12	
50-63	0,25	
80-100	0,46	
125	1,28	

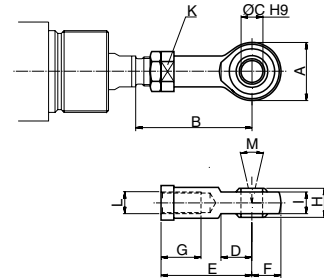

Cyl. Ø mm	A mm	B _{min} mm	B _{max} mm	C mm	D mm	E mm	F mm	G mm	H mm	I mm	K mm	L	M
32	28	50	55	10	15	43	14	15	14	10,5	17	M10x1,25	24°
40	32	56	62	12	17	50	16	22	16	12	19	M12x1,25	24°
50	42	72	80	16	22	64	21	28	21	15	22	M16x1,5	30°
63	42	72	80	16	22	64	21	28	21	15	22	M16x1,5	30°
80	50	87	97	20	26	77	25	33	25	18	32	M20x1,5	30°
100	50	87	97	20	26	77	25	33	25	18	32	M20x1,5	30°
125	70	123,5	137	30	36	110	35	51	37	25	41	M27x2	30°

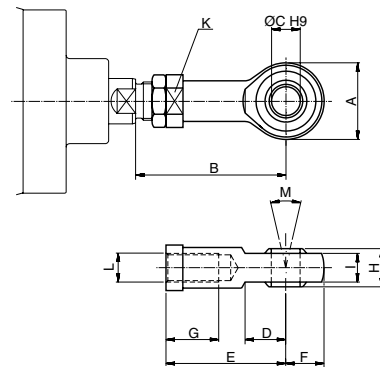

Clevis

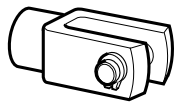

According to ISO 8140
Intended for articulated mounting of the cylinder. This mounting is adjustable in the axial direction. Supplied complete with pin.

Material:
Clevis: stainless steel, DIN X 10 CrNiS 18 9
Pin: stainless steel, DIN X 5 CrNi 18 10
Locking rings according to DIN 471

32	0,09	P1S-4JRD P1S-4LRD P1S-4MRD P1S-4PRD P1S-4RRD
40	0,15	
50-63	0,35	
80-100	0,75	
125	2,10	

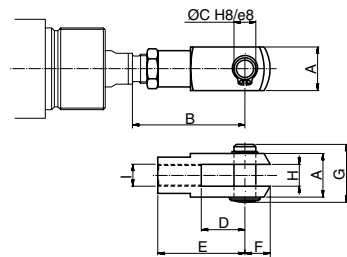

Cylinder Ø mm	A mm	B _{min} mm	B _{max} mm	C mm	D mm	E mm	F mm	G mm	H mm	I
32	20	46	52	10	20	40	12	28	10	M10x1,25
40	24	54	60	12	24	48	19	32	12	M12x1,25
50	32	72	80	16	32	64	25	42	16	M16x1,5
63	32	72	80	16	32	64	25	42	16	M16x1,5
80	40	90	100	20	40	80	32	50	20	M20x1,5
100	40	90	100	20	40	80	32	50	20	M20x1,5
125	55	123,5	137	30	54	110	45	72	30	M27x2

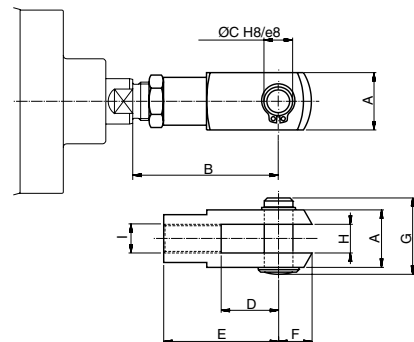

Cylinder mountings

Type	Description	Cyl. bore Ø mm	Weight kg	Order code
Flange MF1/MF2	Intended for fixed attachment of cylinder version D, E, F, or L. The flange is designed for mounting on the front or rear end covers. Material: Stainless steel, DIN X 5 CrNiMo 17 13 3	80	0,97	P1S-4PMB P1S-4QMB P1S-4RMB
		100	1,42	
		125	1,55	

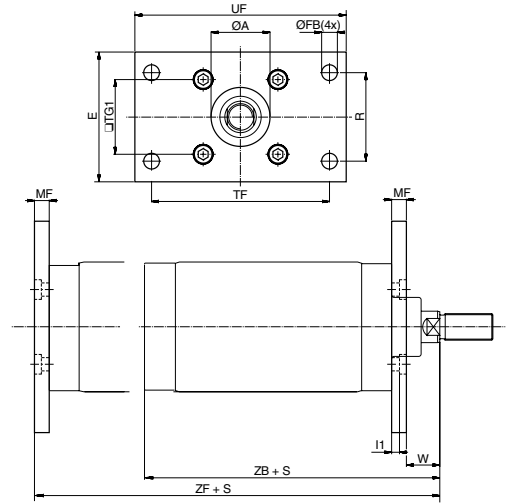
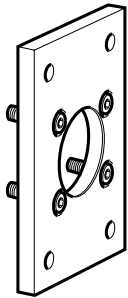

Cylinder Ø mm	A mm	FB mm	E mm	R mm	TF mm	TG1 mm	UF mm	MF mm	I1 mm	W mm	ZB mm	ZF mm
80	50,2	12	86	63	126	46	150	12	6	25	178	190
100	51	14	106	75	150	60	170	12	6	23	193	205
125	61	16	132	90	180	76	205	15	8	32	230	245

S = Stroke

Clevis bracket MP4

Intended for articulated mounting of cylinder versions D, F or L. The bracket is mounted on the rear end cover and is supplied complete with shaft, mounting screw and O-ring for a clean joint between end cover and bracket.

80	0,78	P1S-4PME P1S-4QME P1S-4RME
100	1,42	
125	2,06	

Material:
Bracket: stainless steel, DIN X 5 CrNi 18 10
Pin: stainless steel, DIN X 5 CrNiMo 17 13 3

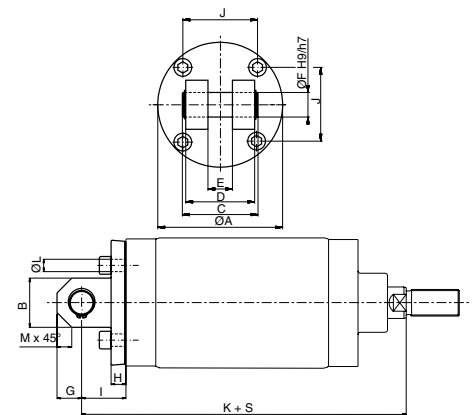
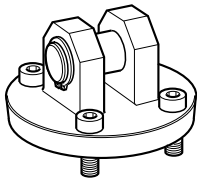

Cylinder Ø mm	A mm	B mm	C mm	D mm	E mm	F mm	G mm	H mm	I mm	J mm	K mm	L mm	M mm
80	80	30	57	50	16	16	15	12	32	46	210	8,6	9
100	103	42	67	60	20	20	21	12	37	60	230	10,6	12
125	127	50	77	70	25	25	25	15	45	76	275	12,6	15

S = Stroke

Mounting nut

Intended for fixed mounting on the front end cover of cylinders according to cylinder version C or D.

80-100	0,16	9126461304 9126461305
125	0,19	

Material:
Stainless steel, DIN X 5 CrNi 18 10

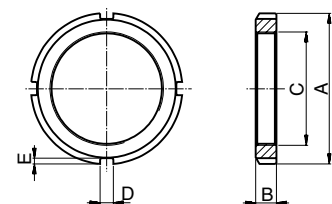

Cylinder Ø mm	A mm	B mm	C	D mm	E mm
80	70	11	M50x1,5	6	2,5
100	70	11	M50x1,5	6	2,5
125	80	11	M60x2	7	3

Cylinder mountings

Type	Description	Cyl. bore Ø mm	Weight kg	Order code
Combinated mounting MP2/MP4	Intended for articulated mounting of cylinder versions D, F or L. The unit is mounted on the rear end cover and is combined with bearing brackets MP2 and is supplied complete with shaft, mounting screw and O-ring for a clean joint between end cover and bracket.	80 100 125	1,29 2,33 3,30	P1S-4PML P1S-4QML P1S-4RML

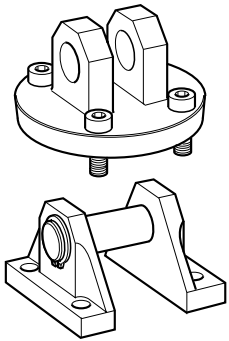

Material:
 Bearing brackets: stainless steel, DIN X 5 CrNi 18 10
 Journal bearing: stainless steel,
 Journal bearing: DIN X 5 CrNiMo 17 13 3/PTFE
 Bracket: stainless steel, DIN X 5 CrNi 18 10
 Pin: stainless steel, DIN X 5 CrNiMo 17 13 3

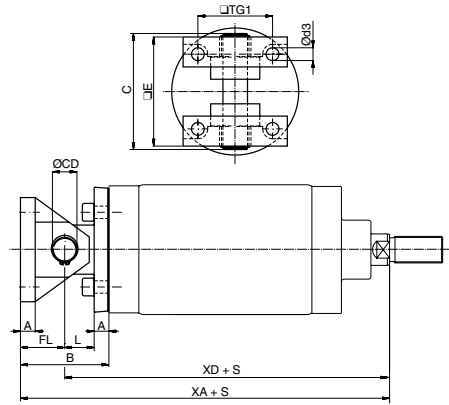

Cylinder Ø mm	A mm	B mm	C mm	CD mm	d3 mm	E mm	FL mm	L mm	TG1 mm	XA mm	XD mm
80	12	64	82	16	9	74	32	20	46	242	210
100	12	74	98	20	11	90	37	25	60	267	230
125	15	90	118	25	13	110	45	30	76	320	275

S = Stroke

Our global series of sensors

This series of sensors is already being used or will be used in all future ranges in our global product programme involving cylinders/actuators. The sensors have small installation dimensions and either fit into the groove in the case profile or, as shown here, are fastened to the cylinder using a special attachment.

You can choose from electronic or reed sensors with a range of cable lengths fitted with 8 mm or M12 terminals.



Electronic sensors

The new electronic sensors are "Solid State", i.e. they have no moving parts at all. They are provided with short-circuit protection and transient protection as standard. The built-in electronics make the sensors suitable for applications with high on and off switching frequency, and where very long service life is required.

Technical data

Design	GMR (Giant Magnetic Resistance) magneto-resistive function
Installation	Sensor mounting P8S-TMC01
Outputs	PNP, normally open (also available in NPN design, normally closed, on request)
Voltage range	10-30 VDC 10-18 V DC, ATEX sensor
Ripple	max 10%
Voltage drop	max 2,5 V
Load current	max 100 mA
Internal consumption	max 10 mA
Actuating distance	min 9 mm
Hysteresis	max 1,5 mm
Repeatability accuracy	max 0,2 mm
On/off switching frequency	max 5 kHz
On switching time	max 2 ms
Off switching time	max 2 ms
Encapsulation	IP 67 (EN 60529)
Temperature range	-25 °C to +75 °C -20 °C to +45 °C, ATEX sensor
Indication	LED, yellow
Material housing	PA 12
Material screw	Stainless steel
Cable	PVC or PUR 3x0.25 mm ² see order code respectively

Reed sensors

The sensors are based on proven reed switches, which offer reliable function in many applications. Simple installation, a protected position on the cylinder and clear LED indication are important advantages of this range of sensors.

Technical data

Design	Reed element
Mounting	Sensor mounting P8S-TMC01
Output	Normally open , or normally closed
Voltage range	10-30 V AC/DC or 10-120 V AC/DC 24-230 V AC/DC
Load current	max 500 mA for 10-30 V or max 100 mA for 10-120 V max 30 mA for 24-230 V
Breaking power (resistive)	max 6 W/VA
Actuating distance	min 9 mm
Hysteresis	max 1,5 mm
Repeatability accuracy	0,2 mm
On/off switching frequency	max 400 Hz
On switching time	max 1,5 ms
Off switching time	max 0,5 ms
Encapsulation	IP 67 (EN 60529)
Temperature range	-25 °C to +75 °C
Indication	LED, yellow
Material housing	PA12
Material screw	Stainless steel
Cable	PVC or PUR 3x0.14 mm ² see order code respectively

Electronic sensors

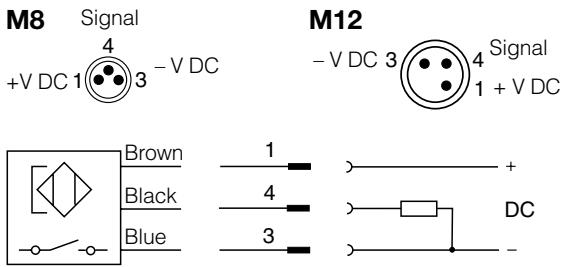

Reed sensors

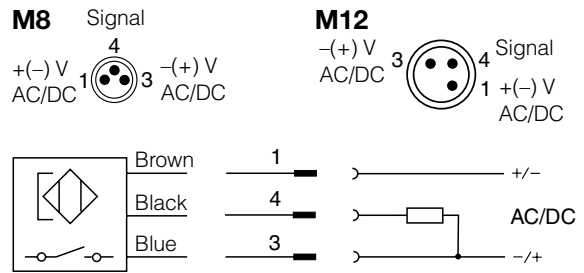

P8S-GCFPX

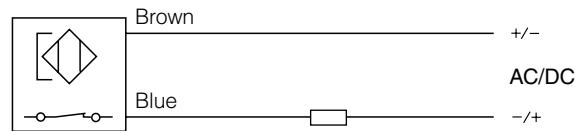

P8S-GRFLX / P8S-GRFLX2

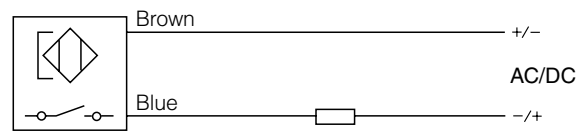

Dimensions

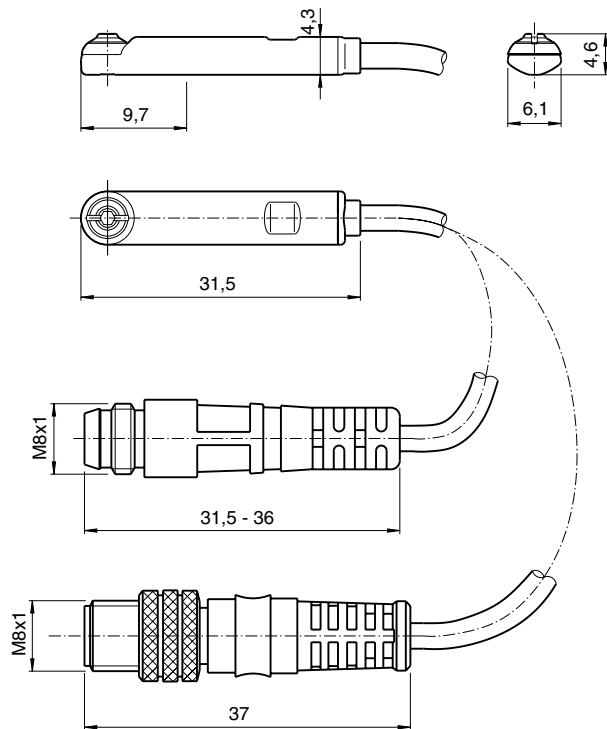

Sensors

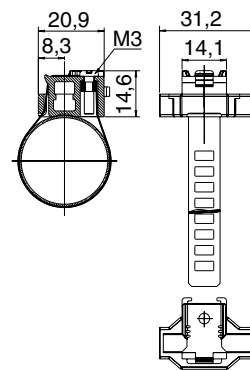

Sensor mounting P8S-TMC**



Ordering data

Output/function	Cable/connector	Weight kg	Order code
Electronic sensors , 10-30 V DC			
PNP type, normally open	0,27 m PUR-cable and 8 mm snap-in male connector	0,007	P8S-GPSHX
PNP type, normally open	1,0 m PUR-cable and 8 mm snap-in male connector	0,013	P8S-GPSCX
PNP type, normally open	1,0 m PUR-cable and M8 screw male connector	0,013	P8S-GPCCX
PNP type, normally open	0,27 m PUR-cable and M12 screw male connector	0,015	P8S-GPMHX
PNP type, normally open	3 m PVC-cable without connector	0,030	P8S-GPFLX
PNP type, normally open	10 m PVC-cable without connector	0,110	P8S-GPFTX
Electronic sensor 18-30 V DC			
ATEX-certified			
<div style="border: 2px solid black; padding: 5px; display: inline-block;">   II3G EEx nA II T4X II3D 135 °C IP67 </div> See ATEX information pages 14 to 17			
Type PNP , normally open	3 m PVC-cable without connector	0,030	P8S-GPFLX/EX
Reed sensors , 10-30 V AC/DC			
Normally open	0,27 m PUR-cable and 8 mm snap-in male connector	0,007	P8S-GSSHX
Normally open	1,0 m PUR-cable and 8 mm snap-in male connector	0,013	P8S-GSSCX
Normally open	1,0 m PUR-cable and M8 male connector	0,013	P8S-GSCCX
Normally open	0,27 m PUR-cable and M12 screw male connector	0,015	P8S-GSMHX
Normally open	1,0 m PUR-cable and M12 screw male connector	0,023	P8S-GSMCX
Normally open	3 m PVC-cable without connector	0,030	P8S-GSFLX
Normally open	10 m PVC-cable without connector	0,110	P8S-GSFTX
Normally closed	5m PVC-cable without connector ¹⁾	0,050	P8S-GCFPX
Reed sensors, 10-120 V AC/DC			
Normally open	3 m PVC-cable without connector	0,030	P8S-GRFLX
Reed sensorer, 24-230 V AC/DC			
Normally open	3 m PVC-cable without connector	0,030	P8S-GRFLX2

1) Without LED

Sensor mounting

Description	Weight kg	Order code
Sensor mounting for cylinder P1S cylinder bore Ø10 to Ø25 mm	0,07	P8S-TMC01
Sensor mounting for cylinder P1S cylinder bore Ø32 to Ø63 mm	0,07	P8S-TMC02
Sensor mounting for cylinder P1S cylinder bore Ø80 to Ø125 mm	0,07	P8S-TMC03

Sensors for special applications

Sensors for applications where the short installation length and the 90 degree cable outlet are important factors. This type of sensor is an good alternative if a cylinder has a short stroke or tight installation, and installation is easier than our global series of sensors.

Technical data

Design	Hall element
Output	PNP resp. NPN, N.O.
Voltage range	10-30 VDC
Max permissible ripple	10%
Max voltage drop	≤0,5 V at 100 mA
Max load current, P1A-2XMK, LK	150 mA
P1A-2XHK, EK, JH, FH	100 mA
Max breaking power (resistive)	6 W
Internal consumption	<30 mA at 30 V
Min actuating distance	5 mm
Hysteresis	1,1 - 1,3 mm
Repeatability accuracy	±0,1 mm
Max on/off switching frequency	1 kHz
Max on/off switching time	0,8/3,0 μs
Encapsulation, P1A-2XJH, FH	IP 65
Encapsulation, P1A-2XHK, EK, MK, LK	IP 67
Temperature range	-10 °C to +60 °C
Indication	LED
Shock resistance	40 g
Material, housing	Polyamid 11
Material, mould	Epoxy
Cable	PVC 3x0,15 mm ²
Cable incl. female part connector	PVC 3x0,15 mm ²
Connector	Diam. 8 mm snap on
Mounting	Mounting yoke
Material, mounting	Acetal/Stainless steel
Material, screw	Stainless steel

Electronic sensor symbol

P1A-2XMK

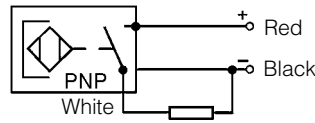

P1A-2XLK

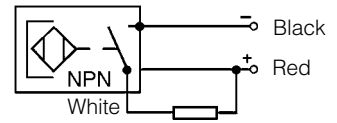

Dimensions

P1A-2XMK and P1A-2XLK

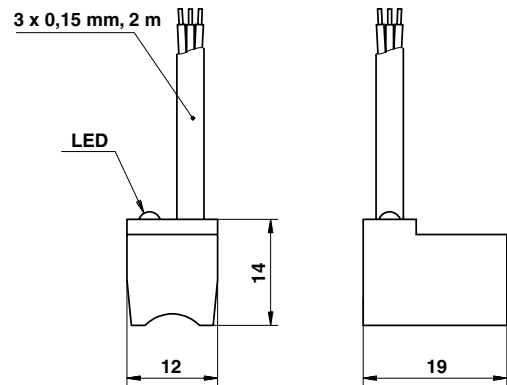

Ordering data

Output	Cable length	Weight kg	Order code
Electronic sensors			
PNP, N.O.	2 m	0,040	P1A-2XMK
NPN, N.O.	2 m	0,040	P1A-2XLK
Mountngs for sensors			
For cylinder Ø10		0,005	P1A-2CCC
For cylinder Ø12		0,005	P1A-2DCC
For cylinder Ø16		0,008	P1A-2FCC
For cylinder Ø20		0,008	P1A-2HCC
For cylinder Ø25		0,010	P1A-2JCC

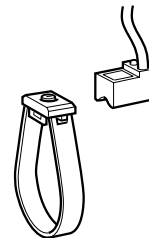

Connecting cables with one connector

The cables have an integral snap-in female connector.



Type of cable	Cable/connector	Weight kg	Order code
Cables for sensors, complete with one female connector			
Cable, Flex PVC	3 m, 8 mm Snap-in connector	0,07	9126344341
Cable, Flex PVC	10 m, 8 mm Snap-in connector	0,21	9126344342
Cable, Super Flex PVC	3 m, 8 mm Snap-in connector	0,07	9126344343
Cable, Super Flex PVC	10 m, 8 mm Snap-in connector	0,21	9126344344
Cable, Polyurethane	3 m, 8 mm Snap-in connector	0,01	9126344345
Cable, Polyurethane	10 m, 8 mm Snap-in connector	0,20	9126344346
Cable, Polyurethane	5 m, M12 screw connector	0,07	9126344348
Cable, Polyurethane	10 m, M12 screw connector	0,20	9126344349

Male connectors for connecting cables

Cable connectors for producing your own connecting cables. The connectors can be quickly attached to the cable without special tools. Only the outer sheath of the cable is removed. The connectors are available for M8 and M12 screw connectors and meet protection class IP 65.



Connector	Weight kg	Order code
M8 screw connector	0,017	P8SCS0803J
M12 screw connector	0,022	P8SCS1204J

Ready to use connecting cables with connectors at each end

As accessories the system comprises a large number of different cables in order to meet all requirements that may arise and to make the installation simple, fast and reliable.

Cables with moulded 8 mm snap-in round contacts in both ends. The cables are available in two types, one with a straight male and female connectors respectively, and one with a straight 3-pole male connector in one end and an angled 3-pole female connector in the other end.



Technical data

Contacts

Moulded 8 mm snap-in male/female contacts.

Enclosure IP67

Cable

Conductor 3x0,25 mm² (32x0,10 mm²)

Sheath PVC/PUR

Colour Black

Cables with straight 3-pole male and female connectors respectively.

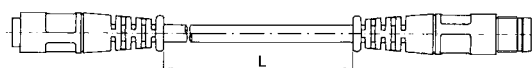

Cables with a straight 3-pole male connector in one end and an angled 3-pole female connector in the other end.

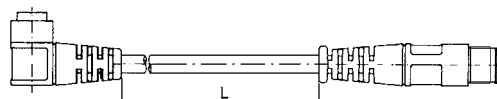

Designation	Weight kg	Order code
Cable with straight contacts, 0,2 m	0,02	9121717014
Cable with straight contacts, 0,3 m	0,02	9121717015
Cable with straight contacts, 0,5 m	0,03	9121717016
Cable with straight contacts, 1,0 m	0,03	9121717017
Cable with straight contacts, 2,0 m	0,05	9121717018
Cable with straight contacts, 3,0 m	0,07	9121717019
Cable with straight contacts, 5,0 m	0,12	9121717020
Cable with straight contacts, 10 m	0,23	9121717021

Designation	Weight kg	Order code
Cable with straight and angled connectors, 0,2 m	0,02	9121717022
Cable with straight and angled connectors, 0,3 m	0,02	9121717023
Cable with straight and angled connectors, 0,5 m	0,03	9121717024
Cable with straight and angled connectors, 1,0 m	0,03	9121717025
Cable with straight and angled connectors, 2,0 m	0,05	9121717026
Cable with straight and angled connectors, 3,0 m	0,07	9121717027
Cable with straight and angled connectors, 5,0 m	0,12	9121717028
Cable with straight and angled connectors, 10 m	0,23	9121717029

Connection block Valvetronic 110

The Valvetronic 110 is a connection block that can be used for collecting signals from sensors at various points on a machine and connecting them to the control system via a multicore cable. Valvetronic 110 can also be used for central connection of the multi-core cable to the outputs of a control system, and can be laid to a machine where the output signals can be connected. The connection block has ten 8 mm snap-in circular connectors and a multi-core cable which is available in lengths of 3 or 10 m. The connections on the block are numbered from 1 to 10. Blanking plugs are available for unused connections, as labels for marking the connections of each block.



Technical data

Connections:

Ten 3-pole numbered 8 mm round snap-in female contacts

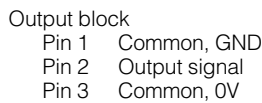
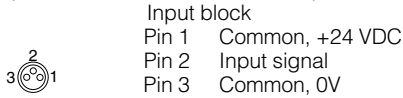

Electrical data:

Voltage 24 VDC (max. 60 V AC/75 V DC)
 Insulation group according to DIN 0110 class C
 Load max. 1 A per connection total max. 3 A

Cable:

Length 3 m or 10 m
 Type of cable LifYY11Y
 Conductor 12
 Area 0.34 mm²
 Colour marking According to DIN 47 100

Mechanical data

Enclosure IP 67, DIN 40050 with fitted contacts and/or blanking plugs.
 Temperature -20 °C to +70 °C





Material

Body PA 6,6 VD according to UL 94
 Contact holder PBTP
 Snap-in ring LDPE
 Moulding mass Epoxy
 Seal NBR
 Screws Plated steel

Industrial durability

Good chemical and oil resistance. Tests should be performed in aggressive environments.

Ordering data

Designation	Weight kg	Order code
 Connection block Valvetronic 110 with 3 m cable	0,32	9121719001
 Connection block Valvetronic 110 with 10 m cable	0,95	9121719002
 Blanking plugs (pack of 10) Use blanking plugs to close unused connections.	0,02	9121719003
 Labels (pack of 10) White labels to insert in grooves on the side of the connection	0,02	9121719004

Dimensions and wiring diagrams

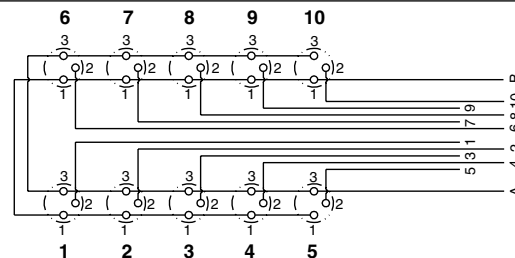
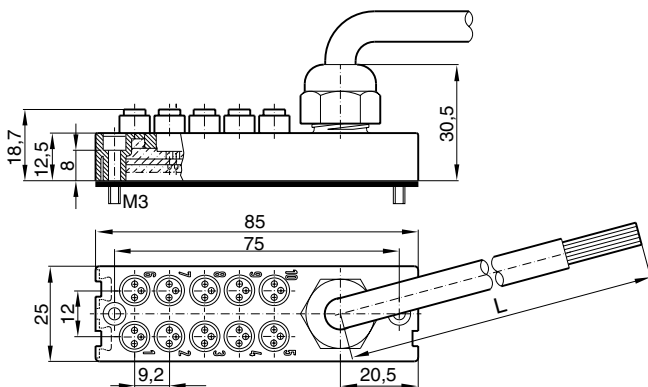

Conductor	Colour	Input	Output
1	Pink	Signal 1	Signal 1
2	Grey	Signal 2	Signal 2
3	Yellow	Signal 3	Signal 3
4	Green	Signal 4	Signal 4
5	White	Signal 5	Signal 5
6	Red	Signal 6	Signal 6
7	Black	Signal 7	Signal 7
8	Violet	Signal 8	Signal 8
9	Grey-Pink	Signal 9	Signal 9
10	Red-Blue	Signal 10	Signal 10
A	Blue	0 V	0 V
B	Brown	+24 V	PE

P1S Series Stainless Steel Pneumatic Cylinders

Seal kits for P1S cylinders

Complete seal kits consisting of:

- Piston seals
- Cushioning seals
- Piston rod bearing
- Piston rod seal
- Scraper ring
- O-rings

Material specification, see pages 19 and 20.

Standard temperature versions

Cylinder designation	Order code
P1S-•032MS	9121659195
P1S-•040MS	9121659196
P1S-•050MS	9121659197
P1S-•063MS	9121659198
P1S-•080MS	9121718905
P1S-•100MS	9121718906
P1S-•125MS	9121718907

High temperature versions

Cylinder designation	Order code
P1S-•032MF	9121720595
P1S-•040MF	9121720596
P1S-•050MF	9121720597
P1S-•063MF	9121720598
P1S-•080MF	9121718925
P1S-•100MF	9121718926
P1S-•125MF	9121718927

Low temperature versions

Cylinder designation	Order code
P1S-•080ML	9121718935
P1S-•100ML	9121718936
P1S-•125ML	9121718937

Standard temperature with Through rod

Cylinder designation	Order code
P1S-•080FS	9121718955
P1S-•100FS	9121718956
P1S-•125FS	9121718957

Standard temperature with stainless steel scraper ring

Cylinder designation	Order code
P1S-•080MQ	9121718915
P1S-•100MQ	9121718916
P1S-•125MQ	9121718917

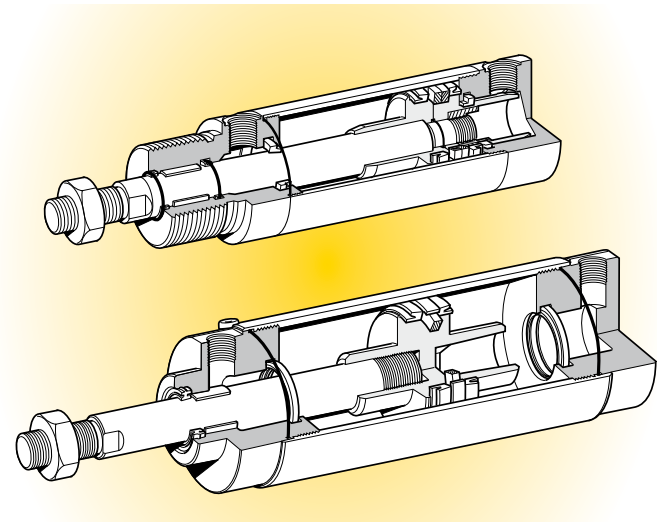

Grease

Version	Weight	Order code
Standard and Low temperature	30 g	9127394541
High temperature	30 g	9127394521

Parker Worldwide

Europe, Middle East, Africa

AE – United Arab Emirates, Dubai
Tel: +971 4 8127100
parker.me@parker.com

AT – Austria, Wiener Neustadt
Tel: +43 (0)2622 23501-0
parker.austria@parker.com

AT – Eastern Europe, Wiener Neustadt
Tel: +43 (0)2622 23501 900
parker.easteurope@parker.com

AZ – Azerbaijan, Baku
Tel: +994 50 2233 458
parker.azerbaijan@parker.com

BE/LU – Belgium, Nivelles
Tel: +32 (0)67 280 900
parker.belgium@parker.com

BY – Belarus, Minsk
Tel: +375 17 209 9399
parker.belarus@parker.com

CH – Switzerland, Etoy
Tel: +41 (0)21 821 87 00
parker.switzerland@parker.com

CZ – Czech Republic, Klecany
Tel: +420 284 083 111
parker.czechrepublic@parker.com

DE – Germany, Kaarst
Tel: +49 (0)2131 4016 0
parker.germany@parker.com

DK – Denmark, Ballerup
Tel: +45 43 56 04 00
parker.denmark@parker.com

ES – Spain, Madrid
Tel: +34 902 330 001
parker.spain@parker.com

FI – Finland, Vantaa
Tel: +358 (0)20 753 2500
parker.finland@parker.com

FR – France, Contamine s/Arve
Tel: +33 (0)4 50 25 80 25
parker.france@parker.com

GR – Greece, Athens
Tel: +30 210 933 6450
parker.greece@parker.com

HU – Hungary, Budapest
Tel: +36 1 220 4155
parker.hungary@parker.com

IE – Ireland, Dublin
Tel: +353 (0)1 466 6370
parker.ireland@parker.com

IT – Italy, Corsico (MI)
Tel: +39 02 45 19 21
parker.italy@parker.com

KZ – Kazakhstan, Almaty
Tel: +7 7272 505 800
parker.easteurope@parker.com

NL – The Netherlands, Oldenzaal
Tel: +31 (0)541 585 000
parker.nl@parker.com

NO – Norway, Asker
Tel: +47 66 75 34 00
parker.norway@parker.com

PL – Poland, Warsaw
Tel: +48 (0)22 573 24 00
parker.poland@parker.com

PT – Portugal, Leca da Palmeira
Tel: +351 22 999 7360
parker.portugal@parker.com

RO – Romania, Bucharest
Tel: +40 21 252 1382
parker.romania@parker.com

RU – Russia, Moscow
Tel: +7 495 645-2156
parker.russia@parker.com

SE – Sweden, Spånga
Tel: +46 (0)8 59 79 50 00
parker.sweden@parker.com

SK – Slovakia, Banská Bystrica
Tel: +421 484 162 252
parker.slovakia@parker.com

SL – Slovenia, Novo Mesto
Tel: +386 7 337 6650
parker.slovenia@parker.com

TR – Turkey, Istanbul
Tel: +90 216 4997081
parker.turkey@parker.com

UA – Ukraine, Kiev
Tel: +380 44 494 2731
parker.ukraine@parker.com

UK – United Kingdom, Warwick
Tel: +44 (0)1926 317 878
parker.uk@parker.com

ZA – South Africa, Kempton Park
Tel: +27 (0)11 961 0700
parker.southafrica@parker.com

North America

CA – Canada, Milton, Ontario
Tel: +1 905 693 3000

US – USA, Cleveland
Tel: +1 216 896 3000

Asia Pacific

AU – Australia, Castle Hill
Tel: +61 (0)2-9634 7777

CN – China, Shanghai
Tel: +86 21 2899 5000

HK – Hong Kong
Tel: +852 2428 8008

IN – India, Mumbai
Tel: +91 22 6513 7081-85

JP – Japan, Tokyo
Tel: +81 (0)3 6408 3901

KR – South Korea, Seoul
Tel: +82 2 559 0400

MY – Malaysia, Shah Alam
Tel: +60 3 7849 0800

NZ – New Zealand, Mt Wellington
Tel: +64 9 574 1744

SG – Singapore
Tel: +65 6887 6300

TH – Thailand, Bangkok
Tel: +662 186 7000 99

TW – Taiwan, Taipei
Tel: +886 2 2298 8987

South America

AR – Argentina, Buenos Aires
Tel: +54 3327 44 4129

BR – Brazil, Sao Jose dos Campos
Tel: +55 800 727 5374

CL – Chile, Santiago
Tel: +56 2 623 1216

MX – Mexico, Apodaca
Tel: +52 81 8156 6000

European Product Information Centre

Free phone: 00 800 27 27 5374

(from AT, BE, CH, CZ, DE, DK, EE, ES, FI, FR, IE, IL, IS, IT, LU, MT, NL, NO, PL, PT, RU, SE, SK, UK, ZA)

Parker Hannifin Ltd.

Tachbrook Park Drive
Tachbrook Park,
Warwick, CV34 6TU
United Kingdom
Tel.: +44 (0) 1926 317 878
Fax: +44 (0) 1926 317 855
parker.uk@parker.com
www.parker.com

